

# BLOW MOLDED PICNIC TABLES



VERSATILE



PORTABLE



DURABLE



*Elevate your  
gatherings with our  
fold-flat picnic table!*

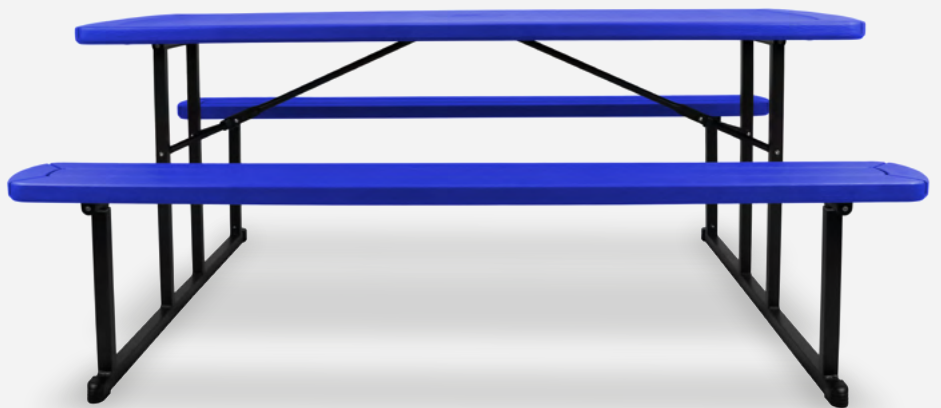

# BLOW MOLDED PICNIC TABLES UNIQUE FEATURES

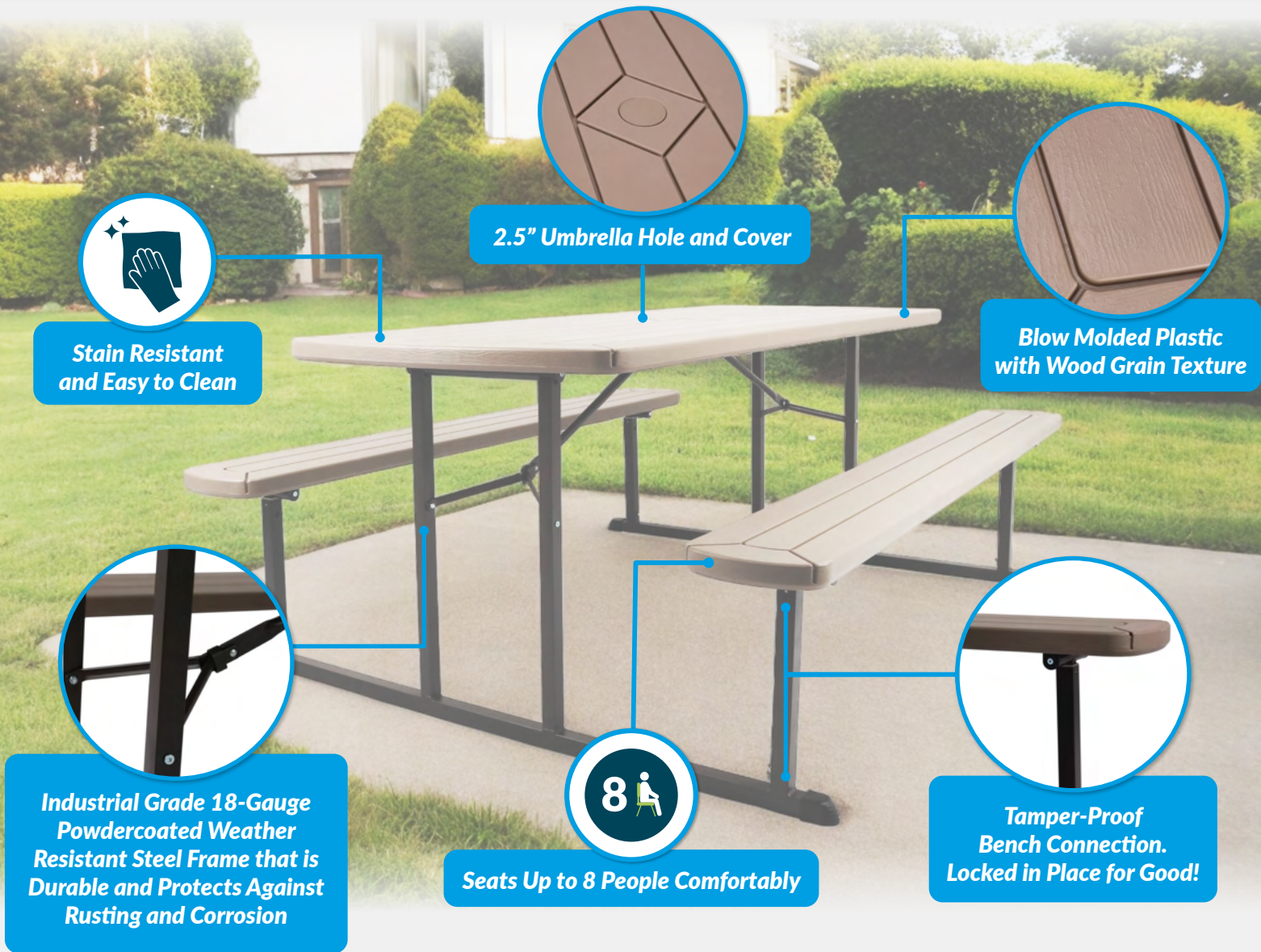

**Stain Resistant and Easy to Clean**

**2.5" Umbrella Hole and Cover**

**Blow Molded Plastic with Wood Grain Texture**

**Industrial Grade 18-Gauge Powdercoated Weather Resistant Steel Frame that is Durable and Protects Against Rusting and Corrosion**

**8 Seats Up to 8 People Comfortably**

**Tamper-Proof Bench Connection. Locked in Place for Good!**

## Instant Picnic Magic: Set Up, Enjoy, Store with Ease!

**Open** 

**Use** 

**Store** 



*Versatility for Every Gathering*



# BLOW MOLDED PICNIC TABLES COLOR OPTIONS

*Make every picnic pop with our  
range of colorful picnic tables.  
Choose your favorite !*







**4** COLORS  
AVAILABLE









*Compactly folds to just 3 inches high, saving valuable storage space!*





**Colors**

			
<b>BMPT3072-BK02</b> Light Speckled Grey Black Frame	<b>BMPT3072-BR03</b> Brown Brown Frame	<b>BMPT3072-BK04</b> Blue Black Frame	<b>BMPT3072-BK06</b> Green Black Frame

**Features**

 <b>1.6" Thick Industrial Grade HDPE Blow Molded Tabletop</b>	 <b>Fold-Flat to a Convenient Height of 3" for Easy Storage and Transportation</b>	 <b>2.5" Umbrella Hole and Cover</b>
 <b>Industrial Grade 18-Gauge Framing System</b>	 <b>Gravity Lock with Clicking Mechanism for Added Stability</b>	 <b>Non-Marring Glides for a Secure Footing without Marking Floors</b>

 can withstand heat up to **212°**

 **1000 lbs**  
evenly distributed

 **800 lbs**  
evenly distributed

**Dimensions**

Open dimensions:

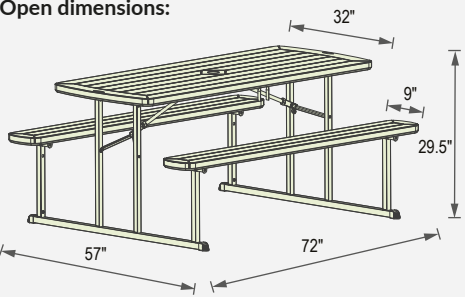

Folded dimensions:  
3" H X 57" D x 72" W

