

**PRODUCT SPECIFICATIONS**

ezH2O® Bottle Filling Station with Mechanically Activated Single ADA Cooler Non-Filtered Non-Refrigerated Light Gray. Features shall include Antimicrobial\*, Green Ticker™, Hands Free, Laminar Flow, Mechanically Activated, Real Drain. Furnished with Flexi-Guard® Safety Bubbler. Electronic Bottle Filler Sensor with Mechanical Front and Side Bubbler Pushbar activation. Product shall be Wall Mount (On Wall), for Indoor applications, serving 1 station(s). Unit shall be certified to UL 399 and CAN/CSA C22.2 No. 120.



<b>Special Features:</b>	Antimicrobial, Green Ticker™, Hands Free, Laminar Flow, Mechanically Activated, Real Drain
<b>Finish:</b>	Light Gray Granite
<b>Power:</b>	115V/60Hz
<b>Bubbler Style:</b>	Flexi-Guard® Safety Bubbler
<b>Activation by:</b>	Electronic Bottle Filler Sensor with Mechanical Front and Side Bubbler Pushbar
<b>Mounting Type:</b>	Wall Mount (On Wall)
<b>Chilling Capacity:</b>	Non-refrigerated
<b>Full Load Amps</b>	2
<b>Rated Watts:</b>	15
<b>Dimensions (L x W x H):</b>	17-7/8" x 18-1/2" x 39-3/4"
<b>Approx. Shipping Weight:</b>	54 lbs.
<b>Installation Location:</b>	Indoor
<b>No. of Stations Served:</b>	1

- Mechanically-Activated unit continues to supply water in event of service disruptions.
- Green Ticker: Informs user of number of 20 oz. plastic water bottles saved from waste.
- Laminar flow provides clean fill with minimal splash.
- Key plastic components are manufactured with silver ion antimicrobial agent helping to provide clean, stain- and odor-free surfaces.
- Real Drain System eliminates standing water.

\*Antimicrobial claims are in reference to components manufactured antimicrobial agents, helping to provide clean, stain- and odor-free surfaces.

**Included with Product:** Water Cooler (EMABFDWSL), Bottle Filler (EZWSR)

**▼ Ships in multiple boxes.**

A Century of Tradition and Quality. For more than 100 years, Elkay has been making innovative products and providing exceptional customer care. We take pride in offering plumbing products that make life easier, inspire change and leave the world a better place.



**PRODUCT COMPLIANCE**

- ADA & ICC A117.1
- ASME A112.19.3/CSA B45.4
- CAN/CSA C22.2 No. 120
- GreenSpec®
- NSF/ANSI 61 (Q≤1) & 372 (lead free)
- UL 399



Complies with ADA & ICC A117.1 accessibility requirements when installed according to the requirements outlined in these standards. Installation may require additional components and/or construction features to be fully compliant. Consult the local Authority Having Jurisdiction if necessary.

[Installation Instructions \(PDF\) - 1000001717](#)

Electrical components and water system are warranted for 12 months from date of installation. **Warranty pertains to drinking water applications only. Non-drinking water applications are not covered under warranty.**

[Warranty \(PDF\)](#)

PART: \_\_\_\_\_ QTY: \_\_\_\_\_

PROJECT: \_\_\_\_\_



CONTACT: \_\_\_\_\_

DATE: \_\_\_\_\_

NOTES: \_\_\_\_\_

APPROVAL: \_\_\_\_\_

*In keeping with our policy of continuing product improvement, Elkay reserves the right to change product specifications without notice. Please visit elkay.com for the most current version of Elkay product specification sheets. This specification describes an Elkay product with design, quality, and functional benefits to the user. When making a comparison of other producers' offerings, be certain these features are not overlooked.*

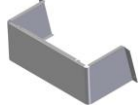
Optional Accessories		
<a href="#">EWF3000</a>	Universal Filtration Kit (3000-Gallon) <a href="#">Spec Sheet (PDF)</a>	
<a href="#">MLP100</a>	In-wall Carrier for Single-station On-wall Bottle Fillers Coolers & Fountains <a href="#">Spec Sheet (PDF)</a>	
<a href="#">98313C</a>	Cane Apron for EMABF (Gray Granite) <a href="#">Spec Sheet (PDF)</a>	

*In keeping with our policy of continuing product improvement, Elkay reserves the right to change product specifications without notice. Please visit [elkay.com](http://elkay.com) for the most current version of Elkay product specification sheets. This specification describes an Elkay product with design, quality, and functional benefits to the user. When making a comparison of other producers' offerings, be certain these features are not overlooked.*

**IMPORTANT!  
INSTALLER PLEASE NOTE :**

This water cooler has been designed and built to provide water to the user which has not been altered by materials in the cooler waterways. The grounding of electrical equipment such as telephone, computer, etc. to water lines is a common procedure. The grounding may be in the building but may also occur away from the building. This grounding can cause electrical feedback into a water cooler creating an electrolysis which creates a metallic taste or causes an increase in the metal content of the water. This condition is avoidable by installing the cooler using the proper materials as shown below.

**NOTICE**

This water cooler must be connected to the water supply using a dielectric coupling. The cooler is furnished with a non-metallic strainer which meets this requirement. The drain trap which is provided by the installer should also be plastic to completely isolate the cooler from the building plumbing system. Bottle filler unit on bracket attached to wall by 6 holes (as shown). Water and electrical will connect through pre-punched hole in basin.

**OPERATION OF QUICK CONNECT FITTINGS**

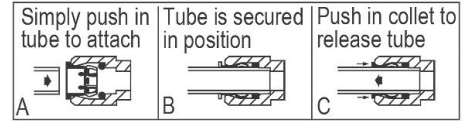

Pushing tube in before pulling it out helps to release tube

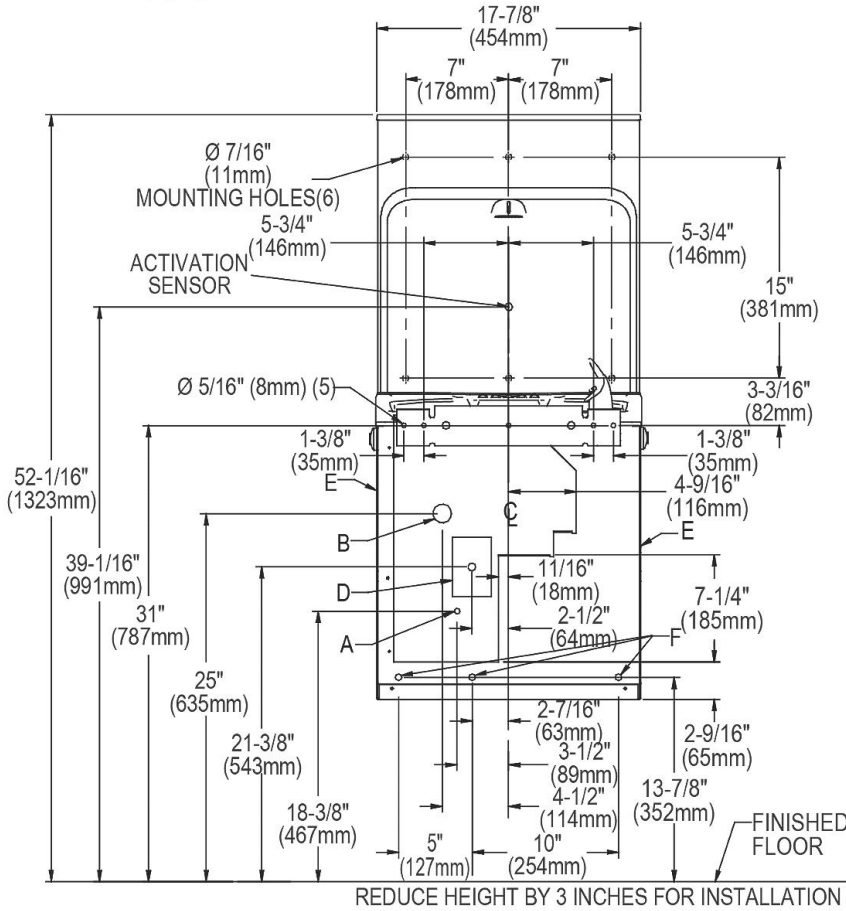
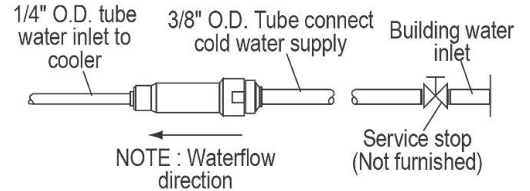

REDUCE HEIGHT BY 3 INCHES FOR INSTALLATION OF CHILDRENS ADA COOLER

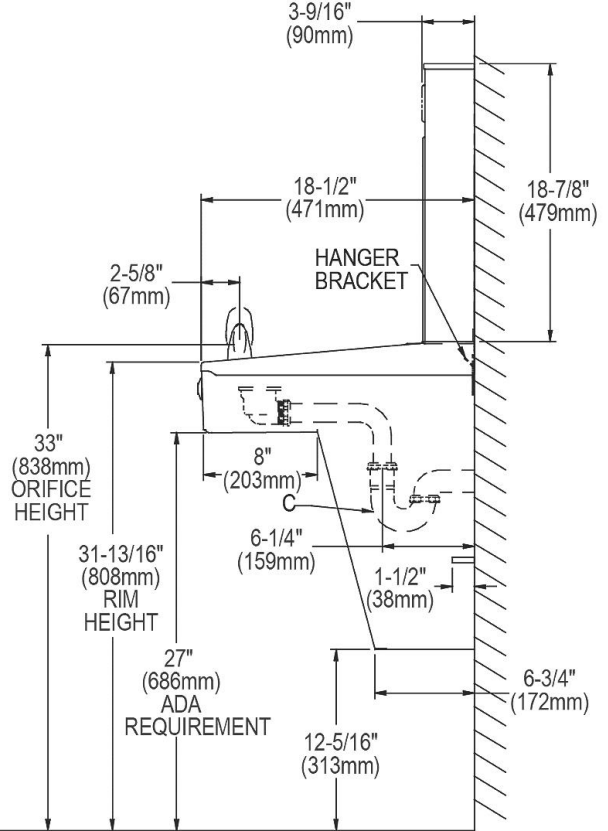

**LEGEND:**

- A = Recommended Water Supply location. Shut-off Valve (not furnished) to accept 3/8" O.D. unplated copper tube. Up to 3" (76mm) maximum out from wall.
- B = Recommended Waste Outlet location. To accommodate 1-1/4" nominal drain. Drain stub 2" (51mm) out from wall.
- C = 1-1/4" Trap (not furnished).
- D = Electrical Supply (3) Wire Recessed Box Duplex Outlet.
- E = Insure proper ventilation by maintaining 6" (152mm) minimum clearance from cabinet louvers to wall.
- F = 7/16" (11mm) Bolt Holes for fastening to wall.

NOTE: New Installations Must Use Ground Fault Circuit Interrupter (GFCI).

In keeping with our policy of continuing product improvement, Elkay reserves the right to change product specifications without notice. Please visit [elkay.com](http://elkay.com) for the most current version of Elkay product specification sheets. This specification describes an Elkay product with design, quality, and functional benefits to the user. When making a comparison of other producers' offerings, be certain these features are not overlooked.