



EZ-RO SYSTEMS

INSTALLATION & OPERATION GUIDE

For Reverse Osmosis Systems
with Hydropneumatic Tanks

NOTES

- The appliance is only to be installed in locations where its use and maintenance are restricted to trained personnel.
- Children should be supervised to ensure that they do not play with the appliance.
- Cleaning and user maintenance shall not be made by children without supervision.
- The appliance is not suitable for installation in an area where a water jet could be used.
- Substances listed as reduced are not necessarily in your water. System must be maintained according to manufacturer's instructions, including replacement of filter cartridges.
- Your water must be within required influent water characteristic limits for satisfactory operation. If not, the reverse osmosis (RO) membrane cartridge's life may be shortened and your warranty will be voided (see Installation Requirements).
- Install on cold water line only.
- Do not install where system will be exposed to direct sunlight.
- Make certain that installation complies with all state and local laws and regulations. Only use PTFE thread seal tape or plumbers tape without adhesive backing to seal joints. Do not use pipe compound unit; they contain petroleum derivatives which can cause crazing and cracking of the plastic in the filter housing.

WARNINGS

- Installation shall comply with applicable local, state, and national plumbing and electrical regulations.
- The appliance is intended to be permanently connected to the water mains and not connected by a hose-set.
- Before installing the system, make certain your water supply complies with the following operating specifications. Failure to do so may reduce the effectiveness of the system and will void the warranty. Consult your local water treatment utility or a certified water testing lab to determine the quality of your water.
- Do not use with water that is microbiologically unsafe or of unknown quality without adequate disinfection before or after the system. The Pentair EZ-RO System will not protect against disease-causing bacteria or remove naturally occurring harmless bacteria.
- The EZ-RO System contains replaceable components that are critical to the efficiency of the system. Replacement of the reverse osmosis component should be with one of identical specifications, as defined by the manufacturer, to assure the same efficiency and contaminant reduction performance.
- The EZ-RO System has filter cartridges and an RO membrane cartridge included with the system that have limited service lives which are critical for the effective reduction of total dissolved solids. Product water should be tested periodically to verify that the system is working properly.

CAUTIONS

- The EZ-RO System must be protected against freezing which can cause the filter housing to crack, resulting in water leakage.
- Do not use electrical heating tape or a propane torch on this unit.

EZ-RO REVERSE OSMOSIS SYSTEM

INSTALLATION AND OPERATION GUIDE FOR MODEL NUMBERS:

EZ-RO 200/2G EZ-RO 200/10G EZ-RO 375/2G EZ-RO 375/10G
 EZ-RO 200/5G EZ-RO 200/16G EZ-RO 375/5G EZ-RO 375/16G

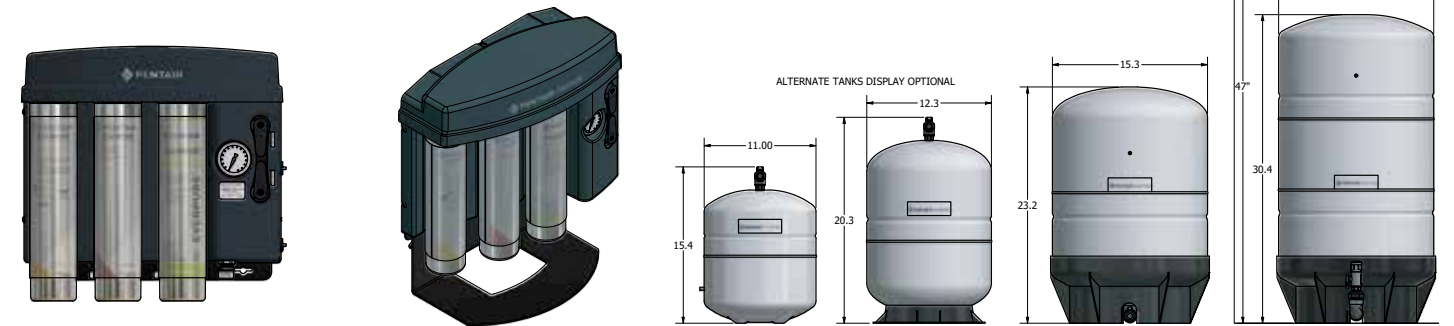

Wall-mounted EZ-RO processor EZ-RO on (optional) floor stand Hydro-pneumatic tank sizes, depending on model purchased:
 2 gal, 5 gal, 10 gal, 16 gal

INDEX

Safety Instructions.....	2	System Startup and Flushing Process.....	11
Introduction.....	3	Pre-Filter and Mineral Addition Flush and Tank Fill.....	11
General Information.....	4	Twenty-four Hour Flush and Soak.....	13
Unpacking and Inspection.....	4	System Dump and Fill, Connect to Equipment.....	14
Part Names.....	5	Filter Change and Flushing Procedure.....	15
Installation Requirements.....	6	Troubleshooting.....	18
Items Required for Installation.....	7	Dimensions.....	20
Using Push-to-Connect Fittings.....	7	Plumbing flow.....	21
Wall-Mount Installation.....	8	Replacement Parts.....	22
Optional Floor Stand Mount Installation.....	8	Warranty Information.....	24
Connect Tubing.....	9	NSF Product Certification Information.....	24
Reject Flow Restrictor Chart.....	10		

INTRODUCTION

Leveraging proprietary technology, the Pentair® Everpure® EZ-RO system provides high quality water for applications, such as steam. The system combines multiple water treatment technologies, that meets combi oven and steamer equipment and customer water quality standards, known to significantly reduce scale and corrosion problems due to high TDS, water hardness†, and chlorides* while reducing dirt†, particulates† and dissolved solids that may foul or scale equipment or may contribute to corrosion.

*When installed, serviced and maintained according to Pentair Everpure installation and operation instructions.

† These contaminants are not performance tested or certified by NSF®.

GENERAL INFORMATION

EZ-RO for Hardness Minerals and Undesirable TDS

Unfiltered water can degrade equipment, which hits foodservice business owners two ways—operational costs and profit loss. Like most reverse osmosis systems, EZ-RO reduces contaminants before they enter the equipment and the end user experience.

EZ-RO reduces high TDS (Total Dissolved Solids) on a molecular level. The 4CM cartridge provides TDS needed for conductivity sensors and optimal mineral content for steam equipment. It achieves next level quality water through its ease of use from install through on-going maintenance, water efficiency, and expandability.

Quality System for Quality Water

EZ-RO features a compact body with a built-in bypass and flush valves, so you cut down on steps during install and servicing. From there, we ensure seamless performance. The reimagined RO solution filters contaminants—all while adding back the minerals you want to protect your equipment. This mineral addition process moderates the right amount of dissolved minerals to achieve your desired final water quality.

Easy – With more accessible parts and no extra SKUs, this all-inclusive system makes specification, installation, and maintenance easier. It's universal, so contractors know what they're dealing with after one encounter.

Expandable – Our system grows with the business by design. The system is compact, yet customizable to expand no matter how it's installed—wall mounted, free standing or under the counter. Upgrade filters or tanks as operational needs increase, as available.

Efficient – The small footprint optimizes space. The remineralization technology safeguards the investment to avoid premature replacements as the high output membrane recovers up to 50% water.

UNPACKING AND INSPECTION

Inspect the carton for damage. Carefully unpack and inspect each item. Report any damage to freight carrier immediately and retain all packaging materials.

The Pentair EZ-RO system includes all the necessary fittings for installation except for an air gap for the waste water. Lengths of 1/4", 3/8", and 1/2" tubing have been provided.

The Pentair EZ-RO system is packaged as a complete unit in two cartons. You should have the following:

Parts	Quantity
Box 1	
1. EZ-RO Processor with Plug	1
2. Pre Filter Cartridge	1
3. 4CM Mineral Addition Cartridge	1
4. EZ-RO Membrane: Size 200 or 375	1
5. Installation Kit, Tubing	1
6. Installation and Operation Guide (not shown)	1
Box 2	
A. HP Tank Assembly: 2, 5, 10, or 16 Gal	1
Box 3	
Optional Floor Stand (if ordered) (See page 22.)	1

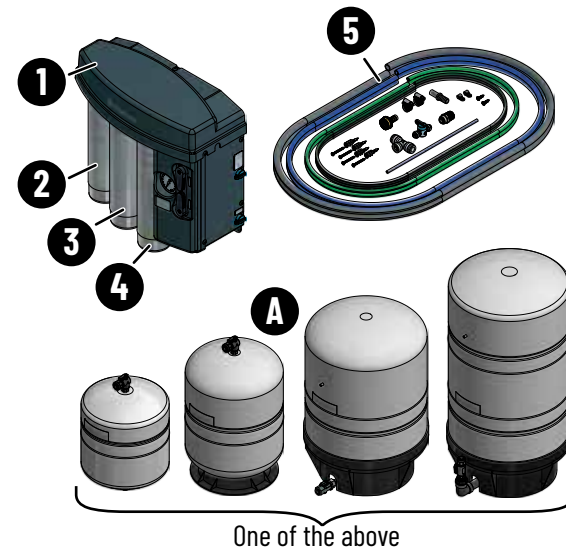

Before mounting the EZ-RO System, inspect the parts. Use the table and illustration provided to verify the parts and quantities. If you do not have these components, do not attempt to install this system. Contact Everpure for assistance. If any parts are missing, contact Customer Service at 800.942.1153 / 630.307.3000 or by email at cseverpure@pentair.com.

PART NAMES

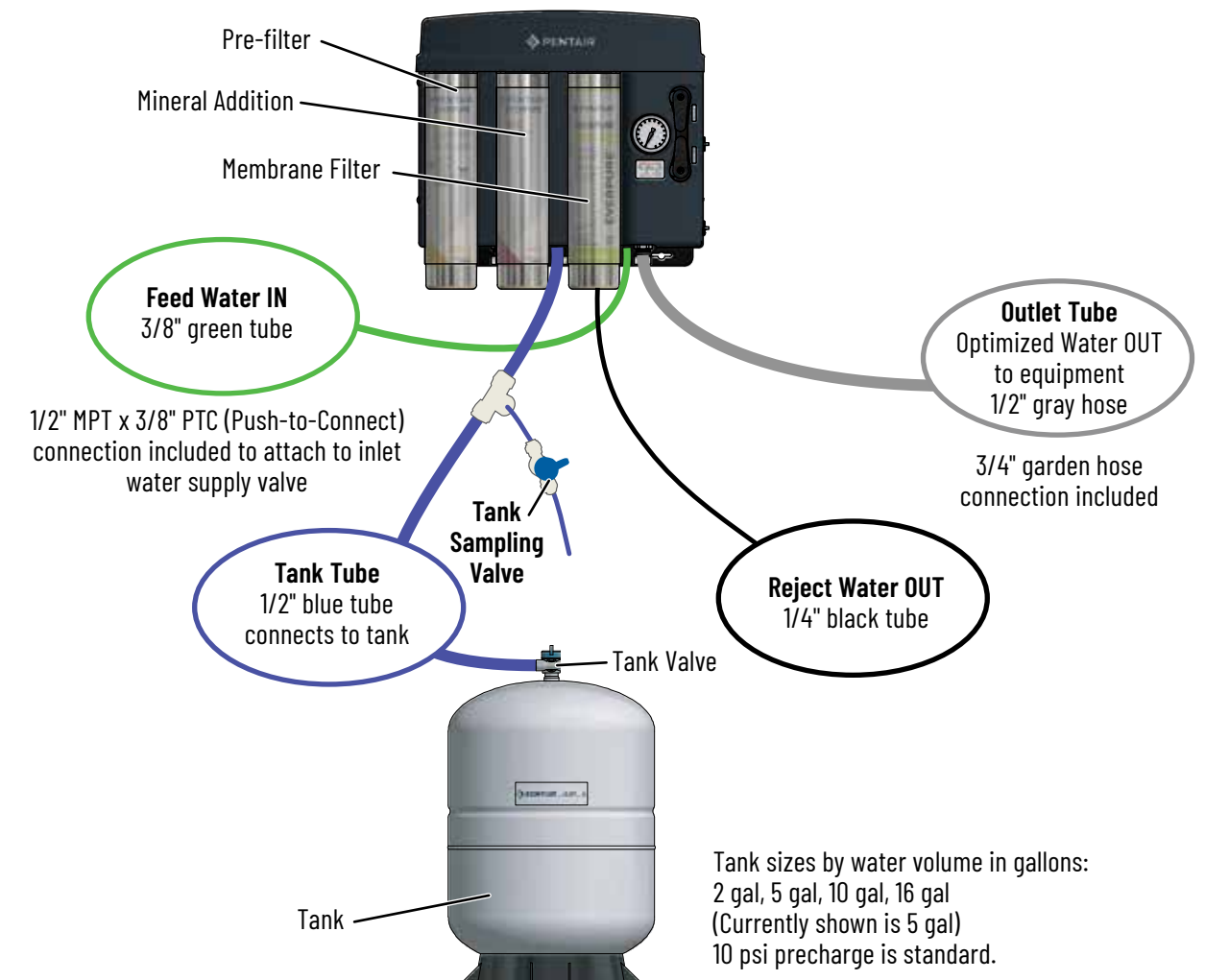
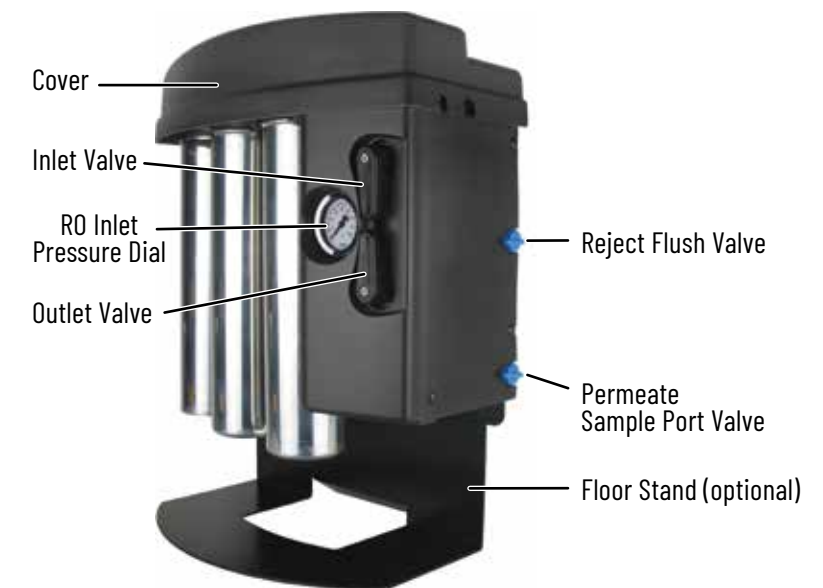

INSTALLATION REQUIREMENTS

This product is for commercial use only and must be installed and maintained in accordance with manufacturer's guidelines and local regulatory plumbing and electrical codes.

LOCATION

The system should be installed indoors and close to:

- RO processor: The hydropneumatic (HP) tank can be no further than 10 feet from the RO processor due to the tubing connections.
- Water source
- Drain (within five feet of unit)
- Equipment served (within 25 feet of unit)

Do not let the processor or storage tank freeze or be exposed to rain or direct sunlight.

WATER REQUIREMENTS

Feed Water

Adequate flow and pressure of water to the unit is essential.

Water supply should be:

- Cold water only
- Minimum 50 psi dynamic pressure, maximum 100 psi static pressure
- Supplied by a dedicated 1/2" water line to the installation

Install a full-flow ball valve and pressure gauge with 1/2" female pipe thread (user supplied) for connection to installation hardware provided with the system.

Feed-water chemistry

Operating a system on water supplies outside of these parameters may lead to premature membrane failure.

Feed TDS	Up to 1000 ppm
Feed pH	5 - 10
Hardness	<12 grains
Free chlorine	<3.0 mg/l
Turbidity	<1.0 NTU
Iron (Fe)	<0.1 mg/l
Manganese	<0.05 mg/l
Hydrogen sulfide	0.0 mg/l
Silica	<20 mg/l

A water analysis must be conducted before installing the system, or the required information can be obtained from your local water utility. If your water analysis shows that any of these parameters are not within range, additional pretreatment and/or higher frequency of maintenance may be necessary. Contact your Everpure distributor for assistance.

The membrane can be fouled by:

- Silica
- Flocculants such as alum or cationic polymers
- Hardness, iron, manganese and hydrogen sulfide

The presence of silica or flocculants in the feed water may require special chemical pretreatment or more frequent membrane replacing. **Please note that membrane failure due to fouling is not covered by the warranty.**

DRAIN

The drain should:

- Be located within five feet of the unit
- Have a locally compliant air gap

The drain must:

- Allow a minimum flow of two gallons per minute
- Be accessible for system set-up and service

STORAGE TANK

The tank must be located **10 feet or less** from the water processor unit. The floor beneath the storage tank should be smooth, clean and free of sharp objects that could scratch or puncture the bottom of the tank.

OPTIMIZED WATER LINES TO EQUIPMENT

Tubing, piping and associated fittings connecting optimized water lines to equipment should be food grade material that meets NSF Standards 51 or 61 with a minimum pressure rating of 100 psi.

Optimized water may react with most metal piping imparting a bad taste. Plastic pipe or reinforced opaque beverage tubing are acceptable choices for optimized water distribution. A 1/2" or larger inside diameter tubing or hose will minimize pressure drop.

ITEMS REQUIRED FOR INSTALLATION

In most cases, common hand tools and plumbing materials suitable for use with potable water are all that is needed for system installation. The system setup and calibration requires special equipment:

- Two - 32 ounce or 1,000 ml graduated containers
- Stopwatch
- Air pressure gauge
- Bicycle tire pump with Schraeder valve
- TDS meter
- Tube cutter
- Pencil or pen
- 5.25% household bleach or equivalent disinfectant
- Full flow ball valve with 1/2" female NPT thread
- Phillips head screwdriver
- PTFE tape
- Adjustable wrench
- Cable ties
- Air gap accessory (optional)
- 1/4" tubing clamps (included)
- Food grade (NSF) plumbers grease,
- 5 gallon bucket (recommended for flushing)
- Four wall anchors to support processor adequately for the installation area walls (included for drywall with wood studs)
OR clean surface on which to place the processor in (optional) stand

NOTE: Consult with your local building inspector for approval and required permits to install this system. Additional equipment may be required. Installation must meet all local and national codes.

USING PUSH-TO-CONNECT FITTINGS

Get to know how to use the tubing connections before going forward.

Fitting Overview

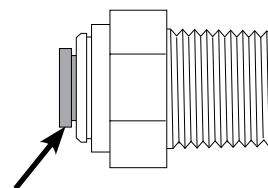

Collet/Gripper (dark gray)

Tubing Preparation

The tubing outside must be free of nicks or gouges.



Cut tubing with a proper tube cutter for a clean, round cut.



After cutting, make sure the end of the tube is round. Fix if needed.

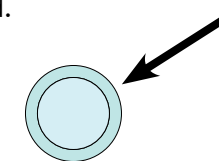

Mark on the tube the depth that it should go in. This will help you see when the tube is fully inserted.

Size and color of tube	Insertion depth to mark
1/4" black	1/2" to 5/8"
3/8" green	3/4" to 7/8"
1/2" blue	1" to 1-1/8"

To Remove Tubing

Press collet in to release the grippers while pulling out the tubing.

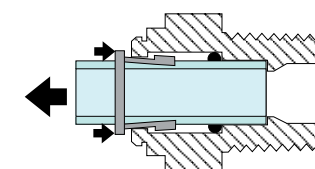

To Attach Tubing

To lubricate, moisten end of tubing with fresh water.

Push tubing straight in.

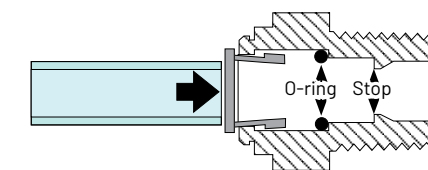

You will feel resistance when the tubing meets the O-ring.

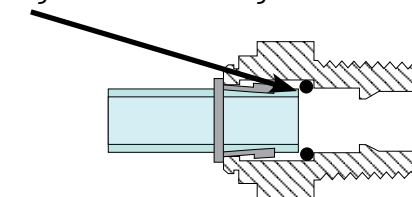

Keep pushing past the resistance until the tubing rests against the stop. Check the mark that you made on the tube to make sure the tube is inserted far enough.

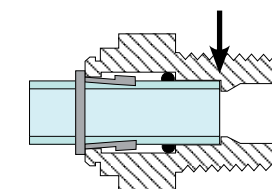

WALL-MOUNT INSTALLATION

Locate system near equipment, drain, and water source.

- Do not block access to controls and filters.
- Leave at least 3" clearance below the cartridges for removal.
- Mount processor where it is well-supported.
- Using appropriate wall anchors or screws, fasten anchors into concrete or screw directly into studs beneath wall board. If using concrete fasteners, follow manufacturer's instructions.

NOTE: If mounting on drywall, locate studs. Make sure that at least two of the anchors will be fastened into a stud.

1. Remove RO processor top cover by loosening phillips screw in the back. Using a level, draw a line where the top or bottom of the bracket will be. Hold the RO processor on the line in the position it will be mounted and mark the four holes on the bracket.
2. Secure RO processor to wall using appropriate wall anchors. Put in screws with enough clearance to install the bracket.
3. How to use the supplied drywall/stud anchors:
 - a. Using #2 Phillips screwdriver, press drywall/stud anchor tip slightly into drywall. Applying pressure, turn anchor. If wood stud is hit, increase pressure. Continue turning anchor until flush.
 - b. Insert screw into anchor and mostly screw it in.
4. Hook processor over all four screws.
5. Slide processor to one side and tighten screws.
 - You can leave cover off until final flushing.

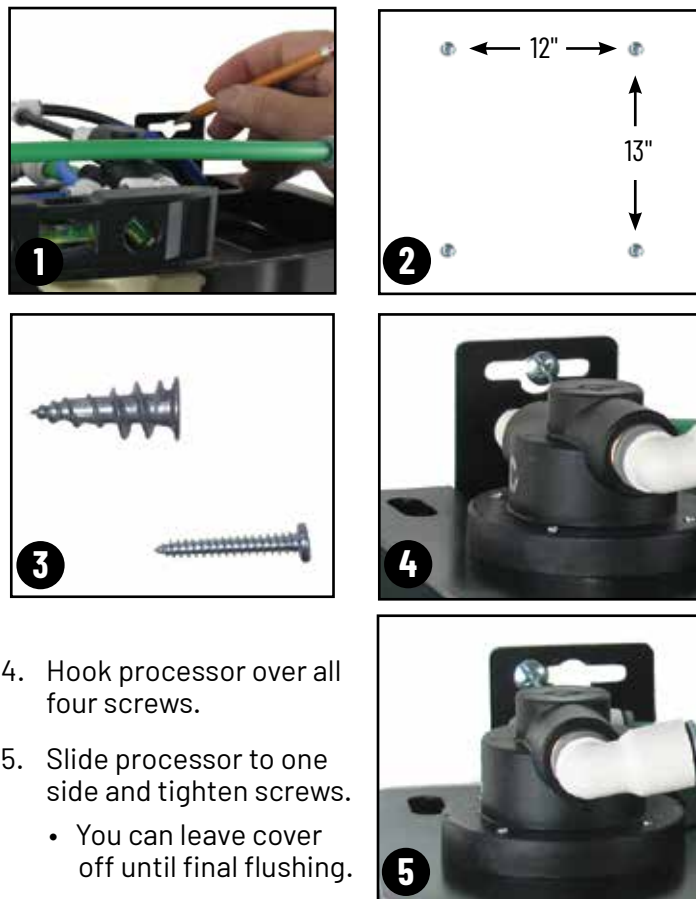

OPTIONAL FLOOR STAND MOUNT INSTALLATION

Locate system in a secure location that's near equipment, drain, and water source.

The floor stand kit part number is: EV315968.

- Do not block access to controls and filters.
1. Note the screw slots and tabs on the floor stand.
 - On 200 and 375 models (size 4 cans: 14.5 inches long) use the lower tabs and screw slots.
 - On 650 models (size 7 cans: 20.75 inches long) use the upper tabs and screw slots.
 2. Hook the appropriate two slots on the back of the processor over two tabs on the floor stand.
 3. From the back of the stand, screw the stand and processor together.
 - You can leave cover off until final flushing.

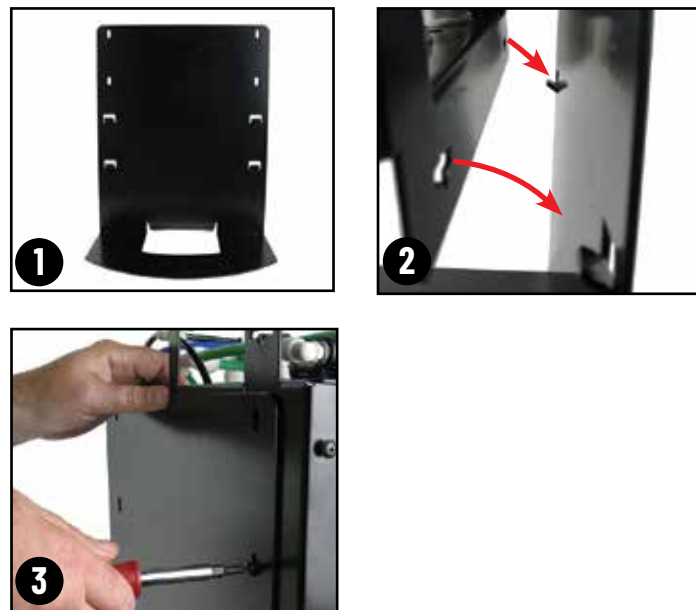

CONNECT TUBING

NOTE:

- Follow instructions from "Using Push-to-Connect Fittings" (page 7) when connecting tubing to fittings.
- At the connections ensure the tubes are cut as straight as possible.
- Elbows are included in the optional floor stand kit to keep the tubing from bending too much, therefore preventing leaks.
- Locate the tank close to the processor, a distance of 10 feet or less.

Inlet Tubing Connections (3/8" Green Tubing)

1. Install 3/8" **green** tubing to FEED WATER IN port at bottom of RO processor.
2. Turn off incoming water supply at valve. Apply three wraps of PTFE tape to NPT threads of 1/2" NPT x 3/8" push to connect. Screw in fitting to NPT threads on water supply valve; hand tighten and tighten to no more than 2ft lbs of torque. Leave enough tubing for servicing and cut tubing to length. Insert other end of 3/8" **green** tubing to 3/8" PTC fitting installed on incoming water supply.

Drain Tubing Connections (1/4" Black Tubing)

3. Install 1/4" **black** tubing to REJECT WATER OUT port.
4. Install the other end of the 1/4" **black** drain tubing to an air gap compliant with local codes. Air gaps are available from Pentair. (optional part no.: 164-89905)
5. Install the air gap to a drain pipe.
6. Secure drain tubing with 1/4" loop clips [two provided] as permeate pump will cause drain line to kick.

Tank Tubing Connections (1/2" Blue Tubing)

7. Install 1/2" **blue** tubing to CONNECT TO TANK port.
- NOTE:** Two and five gallon tanks require tank shutoff valve installation. Install shutoff valve onto 1/4" NPT fitting on tank. Use PTFE tape (thread seal tape) on tank fitting. Twist shut off valve until tight on tank. Do not tighten over 2ft lbs of torque.
8. Cut tubing to length and make connection to TANK VALVE. (Save additional tubing for outlet connection if not using gray hose in next step.)

NOTE: Valves on 10 and 16 gallon tanks have a double O-ring. Make sure the tubing cut is square when viewed from the side and round when viewed from the end. Make sure O-rings are in correct location in fitting. Insert tubing past both O-rings until it comes to a hard stop.

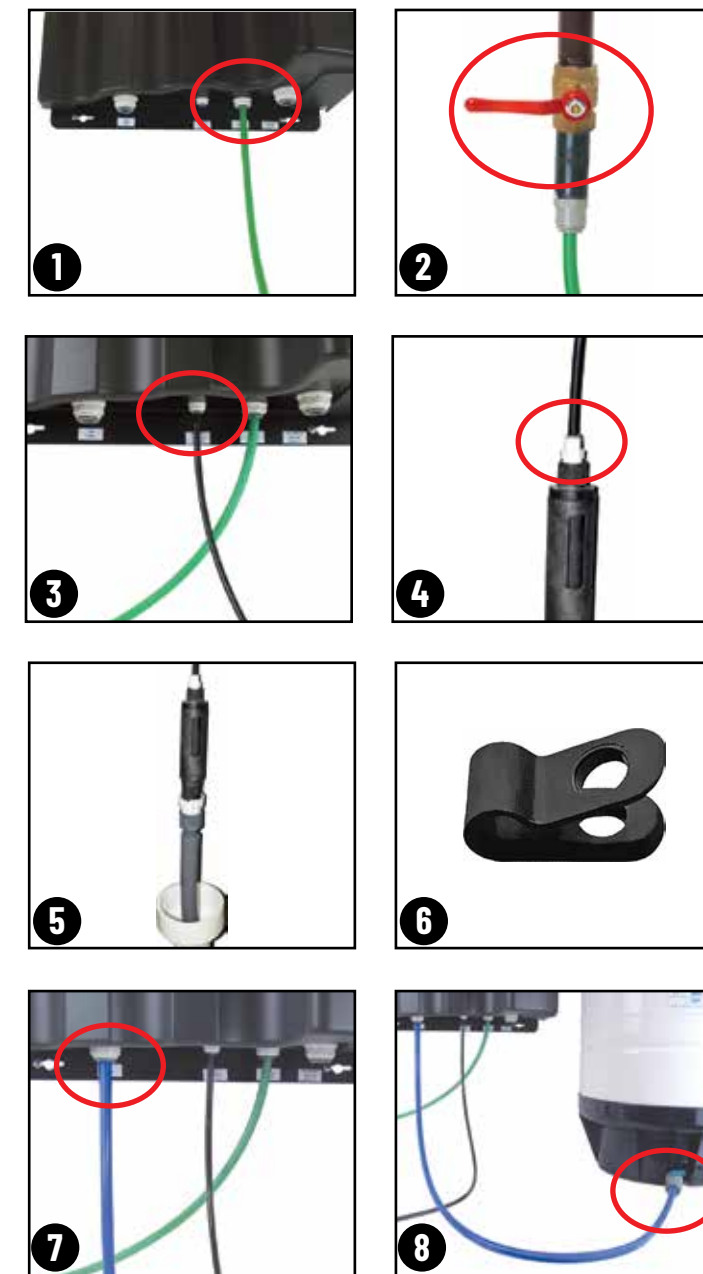

CONNECT TUBING (CONTINUED)

Install Tee with Tank Sampling Valve

9. Install a tee with a sampling valve in a convenient location on the 1/2" line recently installed to the tank. This will be used to sample the water going to the tank and used for flushing the cartridges. Make sure the valve is closed and the end of the tube stays clean.

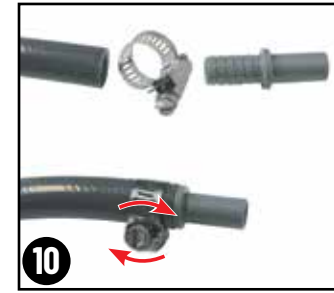
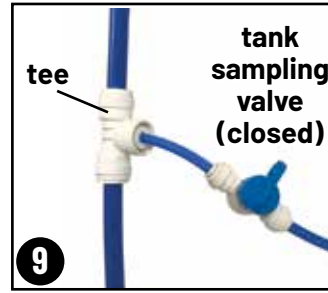

Outlet Tubing Connection (1/2" Gray Hose)

10. Slide band clamp onto the 1/2" gray tubing. Insert 1/2" hose barb adapter into the tube. Slide band clamp close to end of tube and firmly tighten screw.

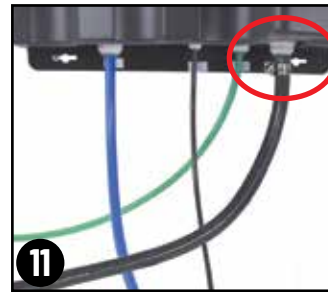

11. Connect 1/2" adapter and hose assembly into OPTIMIZED WATER OUT port on RO processor.

12. Run other end of the gray optimized outlet tube to a clean sink or drain.

IMPORTANT: Do NOT connect to equipment at this time. Connection to equipment will follow flushing process.

NOTE: Make sure outlet tubing will not come dislodged from drain or sink. Water flow rates can cause the tubing to kick.

REJECT FLOW RESTRICTOR CHART

EZ-200 RO Module - Reject Line Flow Restrictor Guide Hydropneumatic Systems			
RO Permeate Production Rate	High	Medium	Low
FEED WATER TDS / PPM	<i>psi greater than 70 or Lpm greater than 0.4</i>	<i>psi between 50 & 70 or Lpm Between 0.3 & 0.4</i>	<i>Low Pressure / Low Temperature Lpm Less than 0.30</i>
Soft Water & >300	GREEN 0.5 Lpm	GREEN 0.5 Lpm	GREEN 0.5 Lpm
300 to 700	GREEN 0.5 Lpm	BLUE 0.7 Lpm	GREEN 0.5 Lpm
700 to 1200	BLUE 0.7 Lpm	BLUE 0.7 Lpm	GREEN 0.5 Lpm

EZ-375 RO Module - Reject Line Flow Restrictor Guide Hydropneumatic Systems			
RO Permeate Production Rate	High	Medium	Low
FEED WATER TDS / PPM	<i>psi greater than 70 or Lpm greater than 0.75</i>	<i>psi between 50 & 70 or Lpm between 0.5 & 0.75</i>	<i>Low Pressure / Low Temperature Lpm Less than 0.50</i>
Soft Water & >300	WHITE 1.052 Lpm*	BLUE 0.735 Lpm	GREEN 0.525 Lpm
300 to 700	WHITE 1.052 Lpm*	WHITE 1.052 Lpm*	GREEN 0.525 Lpm
700 to 1200	GRAY 1.577 Lpm	WHITE 1.052 Lpm*	BLUE 0.735 Lpm

*WHITE 1.052 Lpm flow restrictor comes pre-installed in RO processor. Production rate can be between High/Medium/Low caused by water temperature, incoming pressure (PSI), and TDS of water. NSF testing completed at influent water conditions of 750 PPM TDS and at 50 PSI water, using reject flow restrictor as indicated.

SYSTEM STARTUP AND FLUSHING PROCESS

PRE-FILTER AND MINERAL ADDITION FLUSH AND TANK FILL

1. Install pre-filter into far left position and mineral addition cartridge in middle position. Align cartridge lugs with heads in bracket. Press up and twist a quarter turn.



2. Make sure the membrane plug is installed.

The processor comes with a pre-installed standard reject flow restrictor (white). Water conditions and RO membrane filter size will determine what color flow restrictor may be required to have your EZ-RO system operating the most efficiently.

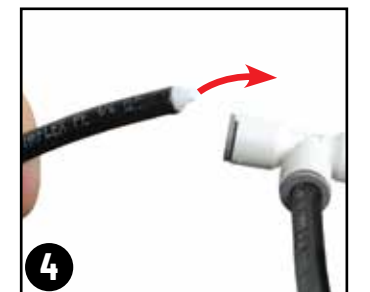
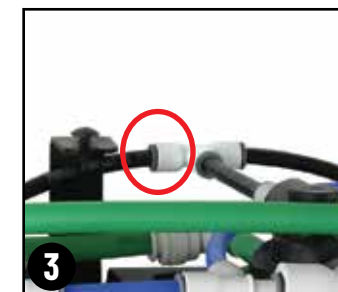

Record the feed water conditions of incoming TDS (Total Dissolved Solids) measured in PPM (Parts per Million) and the incoming water pressure measured in PSI. Then see the "Reject Flow Restrictor Chart" on page 10. Follow chart per system size EZ-200 or EZ-375.

If the chart recommends using the white flow restrictor, skip steps 3 through 6.

3. The reject flow restrictor that will need to be replaced is located on the left side of the 1/4" Tee fitting on the top of the processor connected to the black tubing.

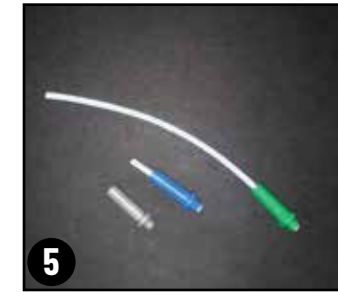

4. Press the gray collet into the fitting and pull the left black tube away from the 1/4" Tee fitting. Pull out the white capillary flow restrictor. This task may require small pliers.

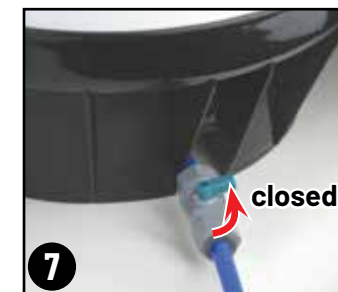

5. After reviewing the "Reject Flow Restrictor Chart" on page 10, choose from the bag located with the manual the color of flow restrictor that best fits your water requirements. Colors included: green, blue, gray. (White is pre-installed.)

6. Insert the selected flow restrictor into the 1/4" black tubing. Firmly insert black tubing into 1/4" Tee fitting. (Reference "Using Push-to-Connect Fittings" on Page 7.)

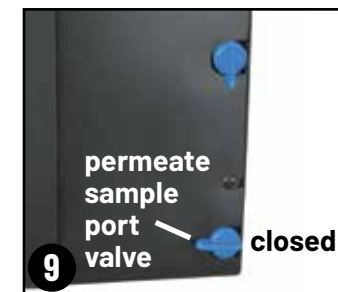

7. On tank, close valve to shutoff position.

8. **Open** the reject flush valve. It's the side middle blue handle. **Open = pointing down.**

9. Check to make sure the permeate sample port valve is in **closed** position. It's the side bottom blue handle. **Closed = pointing left.**

10. Turn the front handles to the following positions: **Inlet valve**—top black handle **pointed down** (open). **Outlet valve**—bottom black handle **pointed to right** (closed).

PRE-FILTER AND MINERAL ADDITION FLUSH AND TANK FILL (CONTINUED)

- Turn on incoming feed water from source.
 - Water will begin to fill RO processor and pre-filter. Water will start to run to the drain.
 - Pressure gauge will show an increased pressure.
 - Check for any leaks. Shut off water and repair leaks if required. Restart step 11.

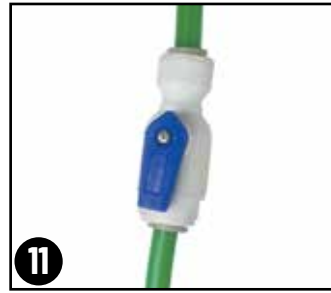

- Slowly open outlet valve (fully) until it is pointing straight up. This will allow water to flush through the optimized water outlet tube and reject line.

NOTE: Reject line will pulse from permeate pump. This is normal.

- Flush for five minutes or until water runs clear.

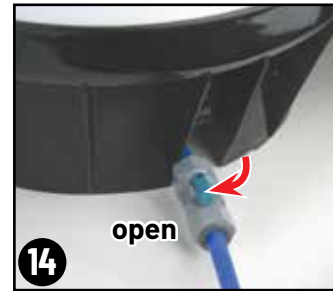

FILL TANK WITH WATER

NOTE: This action fills the tank for a 24 hour tank soak and rinse.

- Open tank valve
 - Tank will begin filling with filtered water.
- Close outlet valve.
- Allow tank to fill.
 - Tank fill time varies based on tank size.
 - The permeate pump rate of "clicking" will decrease as the tank nears full.
 - When tank is full, the reject flow will stop.

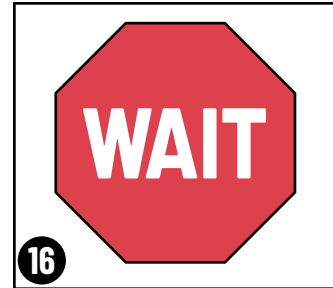

- Once tank is full, close tank valve.

REMOVE SYSTEM PRESSURE

- Open outlet valve: Rotate until pointing up.
- Close inlet valve: Rotate until pointing to right.
 - Optimized water outlet tube and reject tube will exhaust the remaining water that is in the processor.



- Pressure should drop to 0 psi.

IMPORTANT: Bring pressure down to 0 psi before attempting filter changes.



TWENTY-FOUR HOUR FLUSH AND SOAK

- Make sure system pressure is down to 0 psi.
- Remove the membrane plug. Rotate left and pull down.
- Store plug under system cover for future use.
- Install supplied RO membrane cartridge (EZ-200 or EZ-375) into the farthest right position.
- Open inlet valve: Rotate until pointing down.
 - Water will begin to fill the RO processor.
 - Water will start to run out reject and outlet tubes.
 - Ensure both lines are secure with water flowing to drain.
- Flush the system for **one hour**. After one hour **close** the reject flush valve. It's the side middle **blue** handle.

Closed = pointing left.

- Continue to flush for another 23 Hours.
- Recommended: Using a graduated cylinder, record the optimized water flow and reject flow in ounces/min. or ml/min. Fill the graduated cylinder for one minute for each.

Record the values here:

Optimized water _____ Oz or ml _____ /min

Reject water _____ Oz or ml _____ /min

NOTE: Reject water volume in one minute may exceed 32 oz. / 1,000 ml. If so, use a larger container, or collect samples in multiple containers and add all of the collected volumes together.

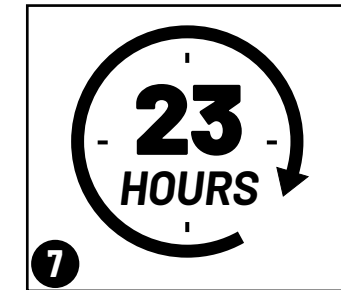
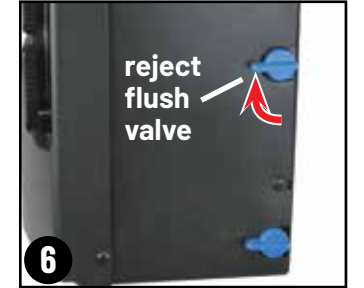
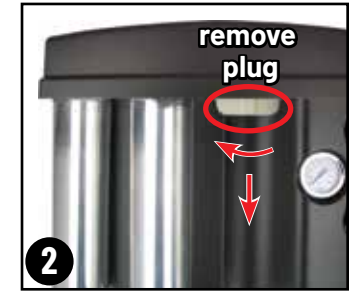

SYSTEM DUMP AND FILL, CONNECT TO EQUIPMENT

- After 24 hours, stop system flush by closing outlet valve: Rotate 90 degrees so that it points to the right.
- Open tank valve, this will allow water from the tank to enter RO processor.

IMPORTANT: Water flow can be very high (5 to 6 GPM). Make sure outlet tube is secure and running to drain.

TANK DUMP AND FILL

- DUMP:** Slowly rotate to open outlet valve until it is pointing up to drain tank water.
- Allow tank to empty. When the flow rate from the optimized outlet tube significantly drops, the tank is empty.
- FILL:** When the tank is empty, close the outlet valve of system to allow tank to fill by rotating valve until pointing to right.
 - Optimized water will begin to fill tank again.
 - Water will be flowing from the reject line based on the flow restrictor your system uses.
- Repeat steps 3-5 for a total of five dumps and fills.

CONNECT TO EQUIPMENT

- Attach garden hose fitting to 1/2" hose.
 - Separate the hose barb adapter into three parts: threaded fitting, barbed flange, gasket. Slide band clamp onto hose first and threaded fitting second.
 - Insert barbed flange into hose.
 - Push until edge of flange is flush with hose tip.
 - Insert gasket into threaded fitting.
 - Slide band clamp to end of hose and tighten screw.
- Connect garden hose to equipment.
- Open outlet valve on RO processor until it is pointing up to allow optimized water to enter equipment.
 - Water will begin to enter equipment.
 - Complete final check for leaks.

System install and flushing complete.

Treated water is now in use at equipment.

NOTE: The tubing/piping and associated fittings connecting the RO water outlet to the equipment being serviced should be food-grade material that meets NSF® Standard 51, 61, or similar, with a minimum pressure rating of 100 psi (6.9 bar, 0.69 MPa). The RO water may react with metal piping, creating a corrosive condition in addition to imparting an objectionable taste. Plastic pipe or reinforced beverage tubing are generally very good material choices for RO water distribution piping. The size of the water tubing/piping should be 1/2-inch (12.7 mm) O.D. minimum.

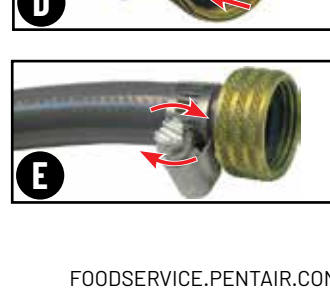
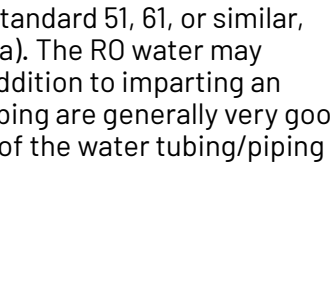
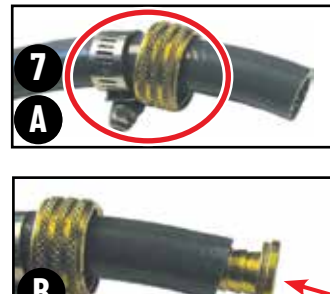
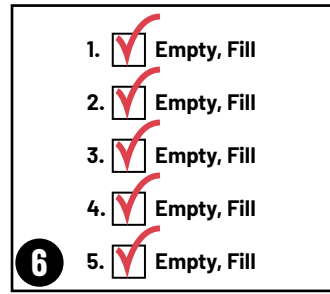
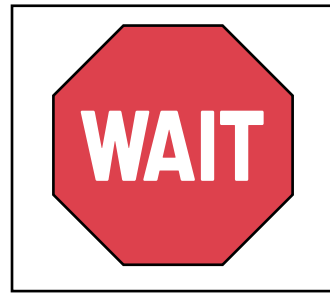
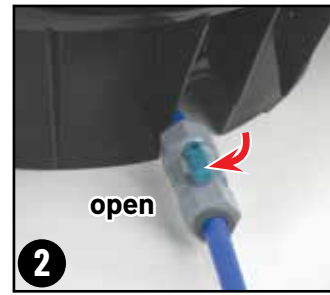

FILTER CHANGE AND FLUSHING PROCEDURE

Recommended: Replace mineral feed cartridge every 6-12 months. For 200 and 375 systems use 4CM cartridge. RO membranes should be replaced every 12-24 months. Prefilters should be replaced every 4-6 months when capacity is reached, or when feed water pressure or flow becomes inadequate.

REMOVE FILTERS

- Turn inlet valve right to the OFF (horizontal) position.
- NOTE:** Feed water is shut off to filters in this "filter change" position.
- Place bucket under RO processor. Open permeate sample port valve (pointing down) to release pressure.
- Make sure incoming pressure is at 0 psi.
- Remove pre-filter, mineral addition, and membrane. Twist filters a quarter turn to left and pull down. Keep membrane if it will not be replaced. Dispose of old cartridges that are being replaced.

REPLACE PRE-FILTER AND MINERAL ADDITION CARTRIDGES, ADD PLUG TO MEMBRANE PORT

- Add new pre-filter to position 1 (insert and turn 90 degrees to right).
 - Add new mineral addition cartridge to position 2 (insert and turn 90 degrees to right).
 - Add RO membrane bypass plug (stored under cover) to the farthest right position (insert and turn 90 degrees to right).
- Close the permeate sample port valve (pointing left).

FLUSH PRE-FILTER AND MINERAL CARTRIDGES

- Turn reject flush valve to open position (pointing down).
- Close tank valve.
 - Optimized water to equipment will be paused during this step.
- Turn outlet valve to closed position - putting equipment into BYPASS.
- Direct end of the tank sampling valve tube into a bucket or drain. Open tank sampling valve.
- Turn inlet valve to open position.
 - Water will start to fill pre-filter and mineral cartridges. Water will run from reject line and tank sampling valve.
- Flush pre-filter and mineral cartridge for 10 minutes or until water runs clear.

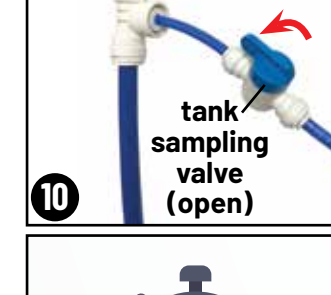
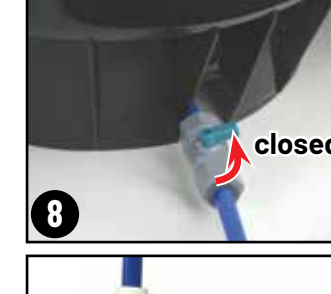
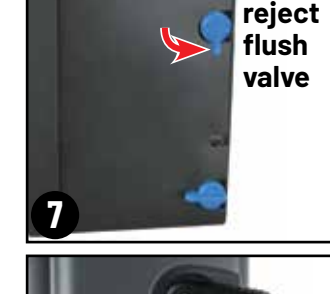

FILTER CHANGE AND FLUSHING PROCEDURE (CONTINUED)

RETURN EXISTING RO MEMBRANE OR REPLACE WITH NEW RO MEMBRANE (IF REQUIRED)

13. Turn inlet valve to closed position (horizontal).
14. The psi gauge will reduce to 0 psi.
15. Remove membrane bypass plug (turn 90 degrees, left and pull down). Store under cover.
16. Insert RO membrane into the farthest right position (insert and turn 90 degrees to right).
17. Turn inlet valve to open position (vertical). Water will start to flush through membrane. Water will run from reject line and tank sampling valve.
18. Close tank line sampling valve.
19. Open tank valve if using existing membrane. Leave closed if installing new membrane.

FLUSH NEW MEMBRANE IF REUSING EXISTING MEMBRANE, SKIP TO STEP 25

20. If needed, put system into partial bypass:
 - Turn inlet valve 45 degrees.
 - Turn outlet valve to the right.

NOTE: Partial bypass allows feed water to go to equipment and also allows water to flush RO membrane. The partial bypass setting will allow untreated water to go to equipment during the RO membrane flushing.

21. Make sure that the reject flush valve and the permeate sample port valves are both open.
Open = pointing down.
22. Continue to flush membrane for one hour.
23. After one hour close reject flush valve.
Closed = pointing left.
24. Continue to flush membrane for 23 hours.

NOTE: Permeate water can be flushed through the tank sampling port instead of the permeate sample port. To do this, close the tank valve, close permeate sample port, and open the tank sampling port. You can run additional tubing from the tank sampling port to a drain.

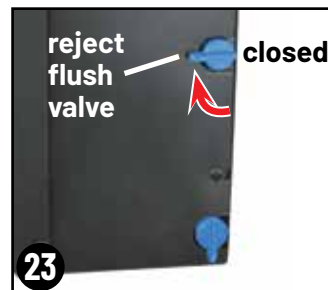
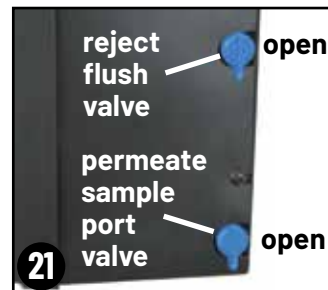
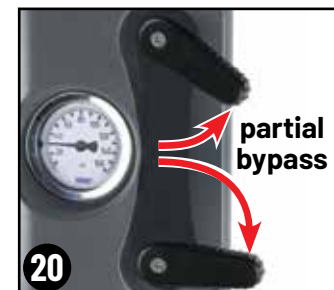
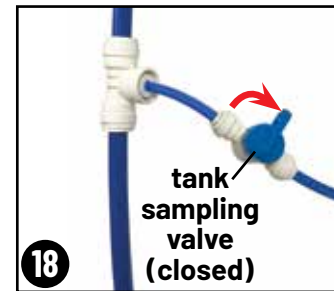

FILTER CHANGE AND FLUSHING PROCEDURE (CONTINUED)

RETURN RO TO NORMAL SERVICE

25. After new membrane flush, or initial flush of existing membrane, make sure that both the reject flush valve and the permeate sample port valve are closed.
Closed = pointing left.
26. Make sure the tank sampling valve is closed.
27. Make sure tank valve is open.
28. Do a final check. Ensure system inlet and outlet valves are returned to service position: inlet (pointing down), outlet (pointing up).

NOTE: This filter change process will cause the customer's equipment to have temporary delay of use of optimized water systems during the 10 minutes of flushing. (New RO membrane flushing will cause extended interruptions to service during flushing.)

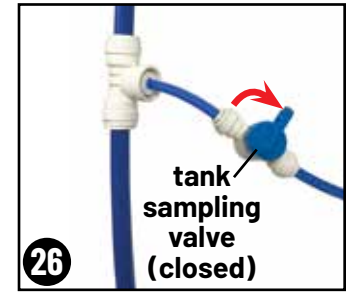
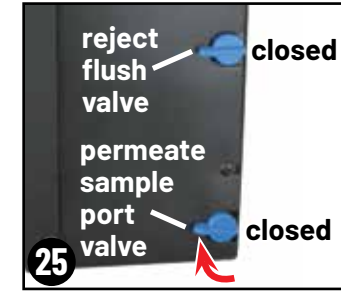

TROUBLESHOOTING

Problem	Possible Cause	Solution
No water running to equipment.	Water supply is turned off.	Turn on the water.
	Water supply is blocked. Prefilter is plugged.	Clear blockage. Change prefilter.
	Membrane cartridge is fouled.	Replace membrane cartridge.
	Incoming water line is crimped or pinched off.	Check incoming line and verify no crimps in line. Remove any pinch points.
Running out of optimized water	Operating pressure reduced	Prefilters need to be replaced.
	Very cold feed water	Feed water temperature too low, increase water temperature up to 80°F to increase production with tempering valve or check if larger RO membrane or tank can be added.
	Valves are in incorrect positions	Ensure the inlet valve and outlet valve on the RO processor are open. See hang tag for normal operation. On the tank, ensure the outlet valve is open.
	Demand exceeds system capacity	Check RO permeate flow. Water temperatures of 48°F will reduce permeate output by 50%. Inlet pressures of 30 psi will reduce permeate output by more than 50% compared to 60 psi inlet. Consult with technical support if permeate flow is too low. Determine if the demand is unusual or inconsistent, or resize system with higher capacity membrane and/or tank.
	Reverse osmosis membrane fouled	Replace reverse osmosis membrane every 12-24 months. See "Short membrane life" page 19 for additional information.
	Low feed water pressure	Install optional feed water pressure booster pump to get pressure up to 60-80 psi. Check outlet pressure of existing booster pump if already installed.
Low TDS rejection <75%	Inlet and outlet valve not in normal operation	See Hang tag for normal operation. Measure reject flow rate and compare to reject flow restrictor chart on page 10. Replace prefilter, capillary flow control and RO membrane as needed. When moving inlet and outlet handles from bypass to service positions, you may detect a pressure imbalance that prevents the outlet handle from reaching full final position. Correcting this issue by turning the valve outlet or inlet handles open and closed again, will help equalize pressure to allow inlet and outlet valves handles to fully engage to the service position.
	Membrane failure	Measure TDS out of permeate sample port. Measure reject flow rate. Replace prefilter and RO membrane as needed. Check to see if the capillary flow control is plugged. Replace capillary flow control as needed.
Nonblended optimized water <25 ppm	Mineral feed cartridge exhausted	Replace mineral feed cartridge with 4CM for 375 system, 7CM for 650 systems every 6-12 months.

TROUBLESHOOTING (CONTINUED)

Problem	Possible Cause	Solution
Short membrane life	Permeate/reject water ratio not adjusted correctly	Measure and adjust the reject flow rate per page 10.
	Poor feed water quality, presence of Hydrogen sulfide, iron, manganese, silica or hard water	Determine feed water quality by obtaining a water quality report from the city water supply utility or contact your Everpure dealer for a water test. See "Water Requirements" on page 6.
	High chlorine levels in feed water	Contact your Everpure dealer for a recommended prefilter change schedule.
	Prefilter filtering capacity has expired	Change prefilter every 6 months or as needed.
Short prefilter life	Heavy sediment loading	Change prefilter more often or add an additional 10 micron coarse prefilter before system (E-10 10 inch filter EV9795-80 or E-20 20 inch filter EV9795-90).
Processor drain does not shut off	Automatic shut off valve malfunction	If water continues to flow to the drain after the tank is full, replace automatic shut off.
Tank full of water but water will not dispense	Tank valve closed	Open tank valve.
	Bladder ruptured	If tank does not hold precharge pressure or water is coming out of Schrader valve, replace tank.
Low water pressure at water using equipment	Tubing between reverse osmosis system and equipment too small	Increase tubing size between reverse osmosis and equipment to 1/2" or larger.
	Incorrect precharge in tank	For hydropneumatic system, precharge tank to 10 psi when empty.
	Bladder ruptured	If tank does not hold precharge pressure or water is coming out of Schrader valve, replace tank.
Objectionable water odor or taste	Additional post filtration needed	Add additional carbon filtration on outlet of system.
Reject water flow rate too low or decreases over time	Drain line restricted	Check/correct any restrictions in drain line tubing, no loops or kinks. Make sure to allow an air gap at the drain. Close RO processor inlet valve, wait for pressure gauge to read zero, disconnect reject line at quick connect fitting and inspect for obstruction or damage. Remove obstruction. Replace tubing and capillary flow control as needed.

Pentair® Everpure® Technical Support:

Tel: 800.942.1153 (US Only) • 630.307.3000 Main • Email: servicespecialist@pentair.com

DIMENSIONS

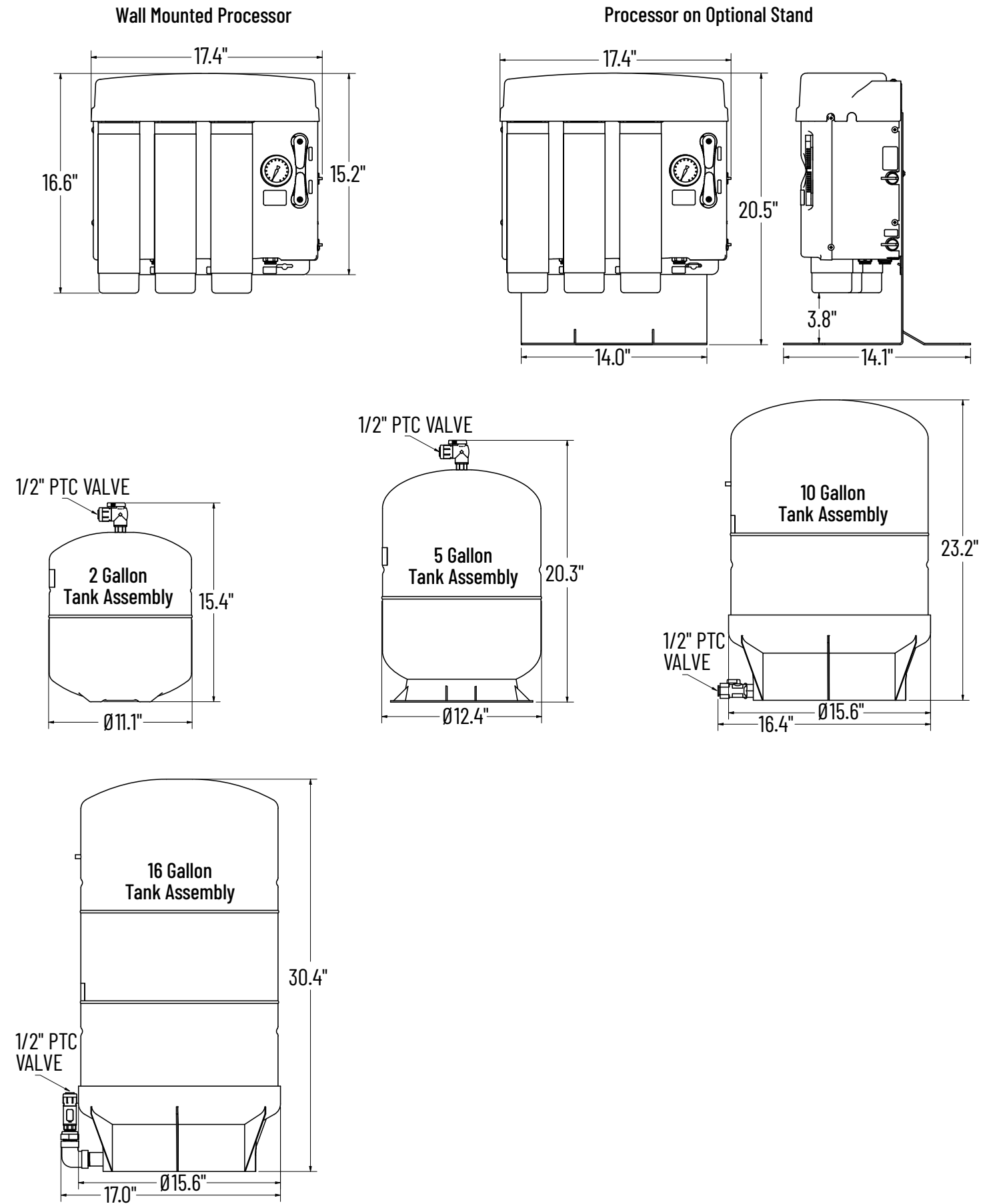

PLUMBING FLOW

EZ-RO 200/375 SYSTEM PLUMBING

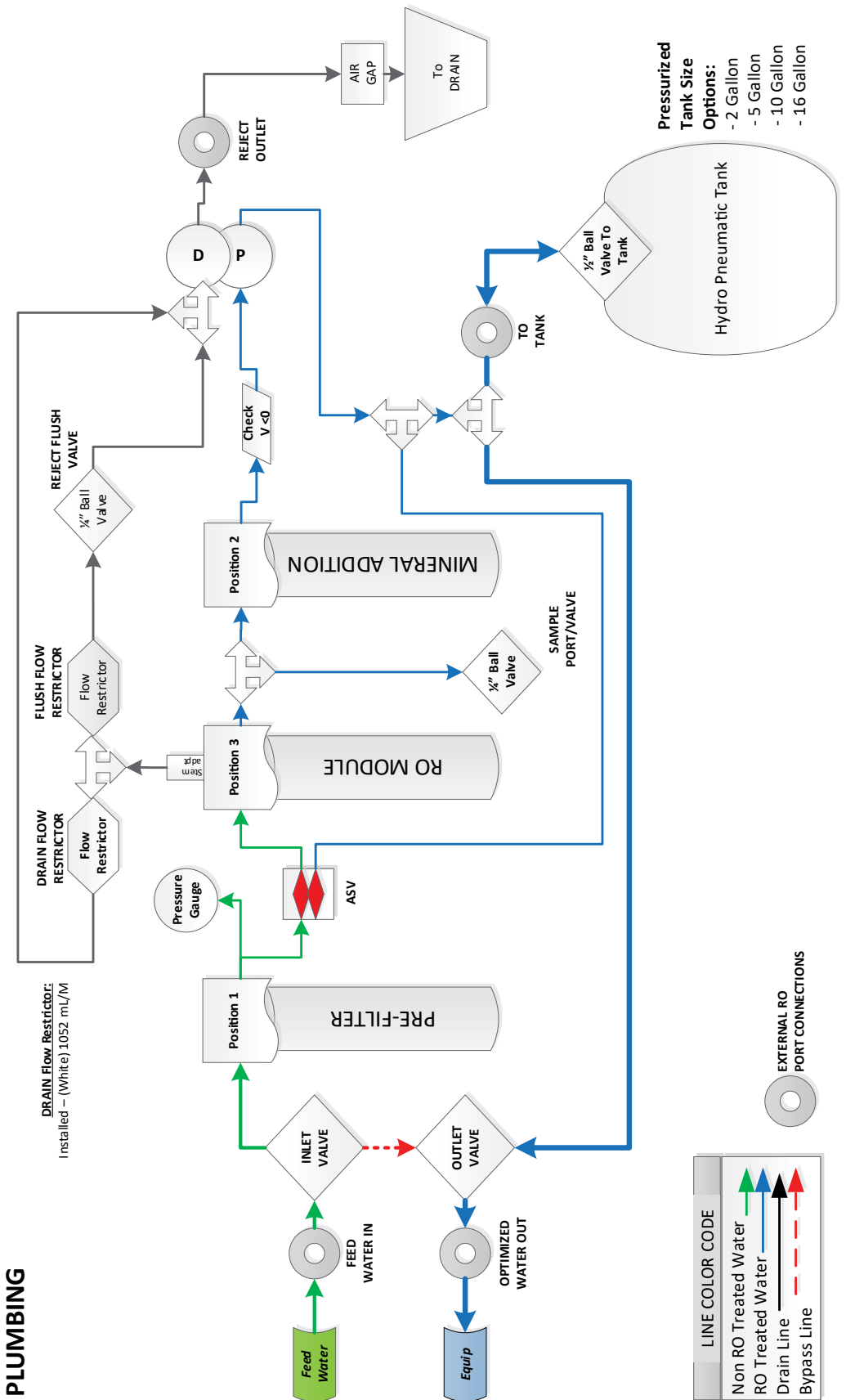

DIMENSIONS

PLUMBING FLOW

REPLACEMENT PARTS

Contact your local Pentair® Everpure® distributor for system replacement parts. To locate your distributor, call customer service at 800.942.1153 or 630.307.3000.

CANISTERS

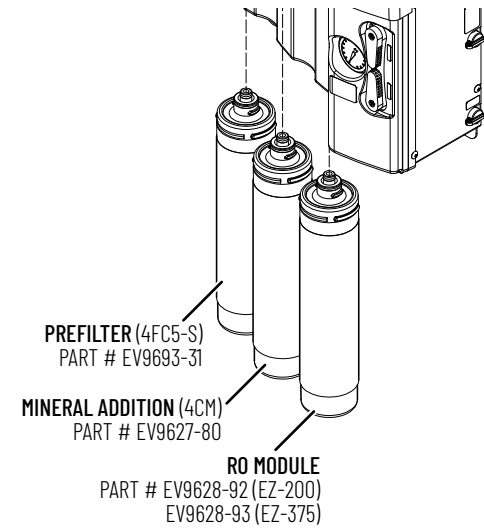

OPTIONAL STAND KIT

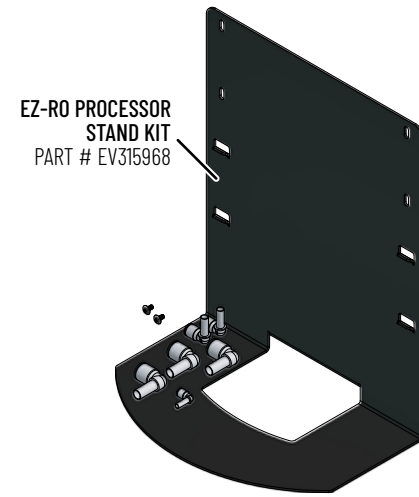

PROCESSOR PARTS

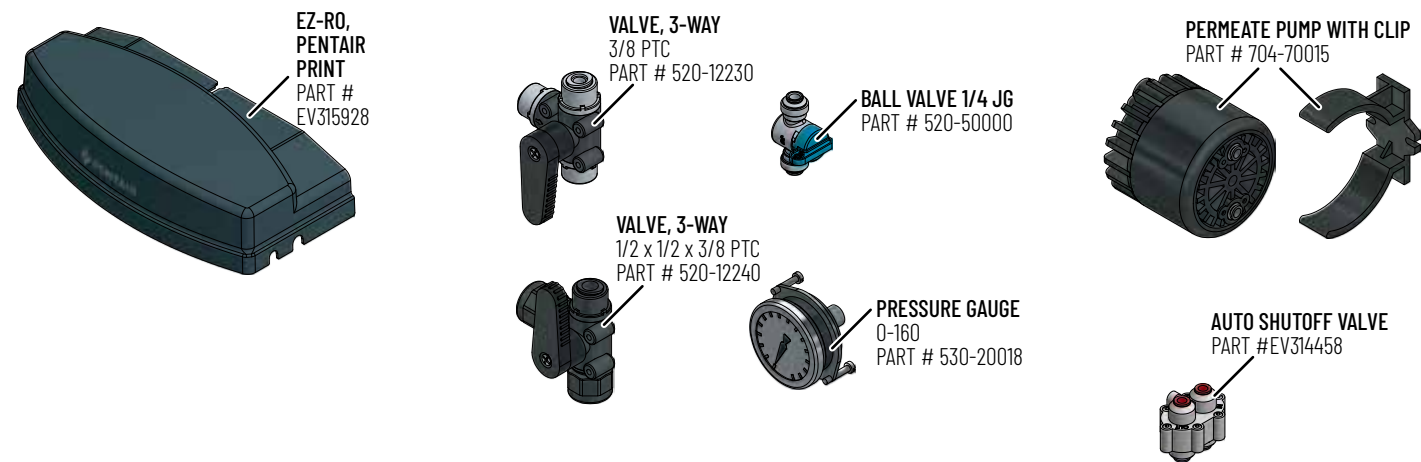

TANK PARTS

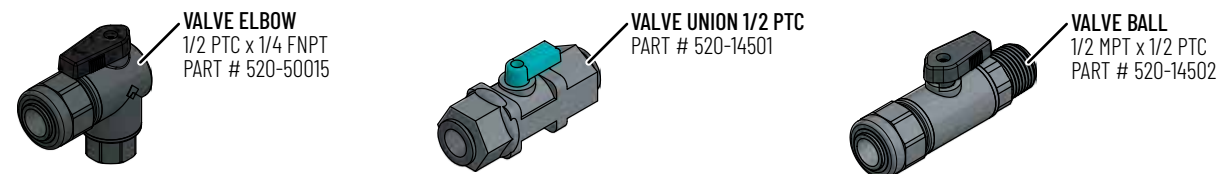



System is Tested and Certified by NSF International against NSF/ANSI 58 and CSA B483.1 for the reduction of Total Dissolved Solids (TDS).

Daily Production Rate: 70.26 gpd
Efficiency Rating: 26.85%
Recovery Rating: 38.40%
Min/Max Working Pressure: 50 - 100 psi (3.5 - 6.9 bar), non-shock
Min/Max Operating Temperature: 40 - 100°F (4.4 - 37.8°C)

Recovery rating means the percentage of the influent water to the membrane portion of the system that is available to the user as RO treated water when the system is operated without a storage tank or when the storage tank is bypassed.

Efficiency Rating means the percentage of the influent water to the system that is available to the user as RO treated water under operating conditions that approximate typical daily use.

For Pentair Everpure Product Warranties visit:
<https://www.pentair.com/assets/foodservice-warranty>

Numerous patents pending on technology and other aspects of the product design.

For Pentair patent information visit:
<http://pentair.com/patents>



United States | 101 S. Gary Ave | Roselle, IL 60172 | 800.942.1153 (US Only) 630.307.3000 Main | cseverpure@pentair.com | foodservice.pentair.com
Australia | 1-21 Monash Drive | Dandenong South, Vic 3175 | Australia | 011.1300 576 190 Tel | au.everpure@pentair.com
China | 21F Cloud 9 Plaza, NO 1118 | Shanghai, 200052 | China | 86.21.3211.4588 Tel | china.water@pentair.com
India | Boulevard, B-9/A, 7th Floor - Tower B Sector 62 | Noida - 201301 | 91.120.419.9444 Tel | indiacustomer@pentair.com
Europe | Pentair Water Belgium BVBA | Industriepark Wolfstee, Toekomstlaan 30, B-2200 Herentals | Belgium | +32.(0)14.283.504 Tel | sales@everpure-europe.com
Japan | Japan Inc. | Hashimoto MN Bldg. 7F, | 3-25-1 Hashimoto, Midori-ku, Sagami-hara-shi | Kanagawa 252-0143 | Japan | 81.(0)42.775.3011 Tel | info@everpure.co.jp
Southeast Asia | 390 Havelock Road, | #04-01 King's Centre | Singapore 169662 | 65.6768.5800 Tel | cseverpure@pentair.com

All indicated Pentair trademarks and logos are property of Pentair. Third party registered and unregistered trademarks and logos are the property of their respective owners.
Pentair is an equal opportunity employer.

©2022 Pentair. All Rights Reserved.

EV3159-30 Rev A AP22

Proof April 18, 2022