

CAMSHELVING

ELEMENTS[®] XTRA

series

STATIONARY | MOBILE | HIGH DENSITY | UNDERCOUNTER

- Posts and traverses made of a revolutionary, extremely strong composite material with a smooth, easy to clean surface. Posts now have notches on the inside only for installing traverse dovetails.
- Removable polypropylene shelf plates with permanent, molded-in Camguard[®], an antimicrobial technology that inhibits the growth of mold, fungus, and bacteria.
- Sturdy reinforced threaded nylon foot adjusts easily to level units.
- Withstands storage temperatures from -36°F to 190°F.
- Lifetime warranty against rust and corrosion.
- NEW patented post connector locks in place onto the wraparound collar wedge for solid, enhanced stability.
- NEW universal traverses can now be installed every 4" on both stationary and mobile units with new single snap on dovetail.
- NEW two piece, heavy-duty corner connectors featuring a "clasp" design offer zero loss of weight bearing in corners and greater weight bearing on middle shelves installed between units.



camguard
ANTIMICROBIAL SHELF PLATES



COMPONENT

Post Connectors, Corner Connectors, Floor Fastener, Wall Fastener, Identification Tags, Single Shelf Security Cage, Ultimate #10 Can Rack, and Shelf Divider Bars are not NSF Listed.

CAMSHELVING ELEMENTS® EXTRA SERIES

Ship complete in 1 box. Includes factory assembled post frames for quicker assembly.

*Sold separately as shelf kits and post kits only.

Stationary Unit Sizes

4 Depths		8 Lengths			3 Heights		
14"*	18"	24"	30"	36"	64"	72"	84"
21"	24"	42"	48"	54"			
		60"	72"				

Standard Mobile

3 Depths			5 Lengths			2 Heights	
18"	21"	24"	32"	42"	48"	70 ¼"	
			54"	60"		78 ¼"	

Stationary Undercounter

2 Depths		3 Lengths			2 Heights	
14"	18"	24"	36"	48"	27 ¼" Mobile	30" Stationary

High Density Mobile

3 Depths			5 Lengths			2 Heights	
18"	21"	24"	36"	42"	48"	70 ¼"	
			54"	60"		78 ¼"	

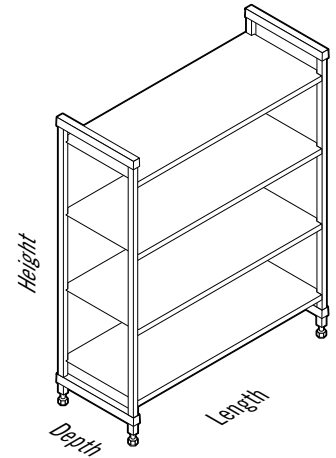

Weight Bearing Capacity

Weight must be evenly distributed across the entire shelf.

		UNIT LENGTH 24" – 60"	UNIT LENGTH 72"
SINGLE UNIT	Unit only	2,400 lbs.	2,400 lbs.
	Shelf only	800	600
	Unit with dunnage stand*	2,800	2,700
	Bottom shelf with dunnage stand*	1,200	900

		UNIT LENGTH 24" – 60"	
CORNER UNIT With 2 Dunnage Stands required	Unit only	2,400	—
	Shelf only	800	—
	Bottom shelf with dunnage stands*	1,200	—

		UNIT LENGTH 24" – 60"	
INTERMEDIATE SHELVES Shelves Installed Between 2 Units	Unit only	2,400	—
	Shelf only	800	—
	Bottom shelf with dunnage stands*	1,200	—
MOBILE UNIT	Unit only**	900	—

*Dunnage Stands add stability and increase weight bearing capacity on bottom shelf only. Highly recommended for Starter Units 54" and longer, all Corner Units, U-Shape Units and units specified for heavier loads. (See Overall Length Quick Reference Guide).

**Due to the weight bearing capacity of casters, maximum weight load on an entire Mobile Unit is 900 lbs. Corner connectors are for use only with shelves 24" - 60" long.

ELEMENTS
XTRA
SERIES

V4

4-SHELF VENTED UNITS

64"
HEIGHT

Starter units include 2 factory assembled stationary post kits, stationary traverses, stationary traverse dovetails and shelf plates. Add-On units include 1 factory assembled stationary post kit, stationary traverses, stationary traverse dovetails and shelf plates. Units ship complete in 1 box.

Starter

Add-On

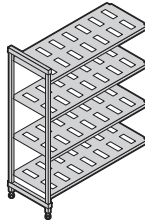
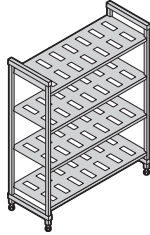

18"
DEPTH

LENGTH	CODE	LIST PRICE EA.
24"	EXU182464V4	\$ 550.00
30"	EXU183064V4	560.00
36"	EXU183664V4	615.00
42"	EXU184264V4	690.00
48"	EXU184864V4	725.00
54"	EXU185464V4	795.00
60"	EXU186064V4	845.00
72"	EXU187264V4	945.00

LENGTH	CODE	LIST PRICE EA.
22"	EXA182464V4	\$ 429.00
28"	EXA183064V4	451.00
34"	EXA183664V4	500.00
40"	EXA184264V4	585.00
46"	EXA184864V4	610.00
52"	EXA185464V4	680.00
58"	EXA186064V4	735.00
70"	EXA187264V4	835.00

21"
DEPTH

24"	EXU212464V4	\$ 595.00
30"	EXU213064V4	610.00
36"	EXU213664V4	670.00
42"	EXU214264V4	760.00
48"	EXU214864V4	790.00
54"	EXU215464V4	880.00
60"	EXU216064V4	940.00
72"	EXU217264V4	1,060.00

22"	EXA212464V4	\$ 472.00
28"	EXA213064V4	489.00
34"	EXA213664V4	560.00
40"	EXA214264V4	645.00
46"	EXA214864V4	675.00
52"	EXA215464V4	765.00
58"	EXA216064V4	820.00
70"	EXA217264V4	940.00

24"
DEPTH

24"	EXU242464V4	\$ 605.00
30"	EXU243064V4	635.00
36"	EXU243664V4	690.00
42"	EXU244264V4	775.00
48"	EXU244864V4	820.00
54"	EXU245464V4	890.00
60"	EXU246064V4	945.00
72"	EXU247264V4	1,070.00

22"	EXA242464V4	\$ 483.00
28"	EXA243064V4	520.00
34"	EXA243664V4	580.00
40"	EXA244264V4	655.00
46"	EXA244864V4	710.00
52"	EXA245464V4	775.00
58"	EXA246064V4	825.00
70"	EXA247264V4	950.00

ELEMENTS
XTRA
SERIES

V4

4-SHELF VENTED UNITS

72"
HEIGHT

Starter units include 2 factory assembled stationary post kits, stationary traverses, stationary traverse dovetails and shelf plates. Add-On units include 1 factory assembled stationary post kit, stationary traverses, stationary traverse dovetails and shelf plates. Units ship complete in 1 box.

Starter

Add-On

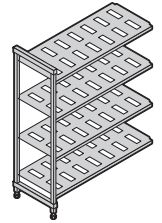
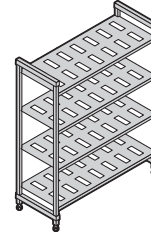

LENGTH	CODE	LIST PRICE EA.
24"	EXU182472V4	\$ 550.00
30"	EXU183072V4	570.00
36"	EXU183672V4	620.00
42"	EXU184272V4	695.00
48"	EXU184872V4	730.00
54"	EXU185472V4	800.00
60"	EXU186072V4	850.00
72"	EXU187272V4	950.00

LENGTH	CODE	LIST PRICE EA.
22"	EXA182472V4	\$ 434.00
28"	EXA183072V4	456.00
34"	EXA183672V4	500.00
40"	EXA184272V4	590.00
46"	EXA184872V4	610.00
52"	EXA185472V4	680.00
58"	EXA186072V4	735.00
70"	EA187272V4	840.00

24"	EXU212472V4	\$ 595.00
30"	EXU213072V4	615.00
36"	EXU213672V4	675.00
42"	EXU214272V4	765.00
48"	EXU214872V4	795.00
54"	EXU215472V4	885.00
60"	EXU216072V4	940.00
72"	EXU217272V4	1,060.00

22"	EXA212472V4	\$ 472.00
28"	EXA213072V4	494.00
34"	EXA213672V4	560.00
40"	EXA214272V4	650.00
46"	EXA214872V4	675.00
52"	EXA215472V4	765.00
58"	EXA216072V4	820.00
70"	EXA217272V4	940.00

24"	EXU242472V4	\$ 610.00
30"	EXU243072V4	645.00
36"	EXU243672V4	695.00
42"	EXU244272V4	775.00
48"	EXU244872V4	825.00
54"	EXU245472V4	900.00
60"	EXU246072V4	950.00
72"	EXU247272V4	1,075.00

22"	EXA242472V4	\$ 483.00
28"	EXA243072V4	525.00
34"	EXA243672V4	585.00
40"	EXA244272V4	655.00
46"	EXA244872V4	710.00
52"	EXA245472V4	780.00
58"	EXA246072V4	825.00
70"	EXA247272V4	955.00

Color: Speckled Gray (480).

V5 5-SHELF VENTED UNITS

84"
HEIGHT

Starter units include 2 factory assembled stationary post kits, stationary traverses, stationary traverse dovetails and shelf plates. Add-On units include 1 factory assembled stationary post kit, stationary traverses, stationary traverse dovetails and shelf plates. Units ship complete in 1 box.

Starter

Add-On

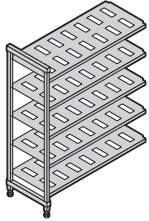
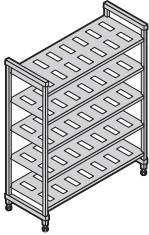

18"
DEPTH

LENGTH	CODE	LIST PRICE EA.
24"	EXU182484V4	\$ 610.00
30"	EXU183084V4	625.00
36"	EXU183684V4	700.00
42"	EXU184284V4	780.00
48"	EXU184884V4	815.00
54"	EXU185484V4	895.00
60"	EXU186084V4	965.00
72"	EXU187284V4	1,080.00

LENGTH	CODE	LIST PRICE EA.
22"	EXA182484V4	\$ 485.00
28"	EXA183084V4	510.00
34"	EXA183684V4	570.00
40"	EXA184284V4	660.00
46"	EXA184884V4	695.00
52"	EXA185484V4	775.00
58"	EXA186084V4	835.00
70"	EXA187284V4	955.00

21"
DEPTH

24"	EXU212484V4	\$ 660.00
30"	EXU213084V4	690.00
36"	EXU213684V4	760.00
42"	EXU214284V4	860.00
48"	EXU214884V4	890.00
54"	EXU215484V4	995.00
60"	EXU216084V4	1,060.00
72"	EXU217284V4	1,195.00

22"	EXA212484V4	\$ 535.00
28"	EXA213084V4	560.00
34"	EXA213684V4	635.00
40"	EXA214284V4	730.00
46"	EXA214884V4	770.00
52"	EXA215484V4	870.00
58"	EXA216084V4	940.00
70"	EXA217284V4	1,065.00

24"
DEPTH

24"	EXU242484V4	\$ 675.00
30"	EXU243084V4	715.00
36"	EXU243684V4	775.00
42"	EXU244284V4	870.00
48"	EXU244884V4	925.00
54"	EXU245484V4	1,005.00
60"	EXU246084V4	1,065.00
72"	EXU247284V4	1,210.00

22"	EXA242484V4	\$ 550.00
28"	EXA243084V4	590.00
34"	EXA243684V4	655.00
40"	EXA244284V4	745.00
46"	EXA244884V4	805.00
52"	EXA245484V4	880.00
58"	EXA246084V4	945.00
70"	EXA247284V4	1,090.00

Color: Speckled Gray (480).

V4 4-SHELF VENTED MOBILE UNITS

Mobile units include 2 factory assembled mobile post kits, mobile traverses, mobile traverse dovetails, shelf plates, and 4 premium swivel casters with total locking brake. Units ship complete in 1 box.

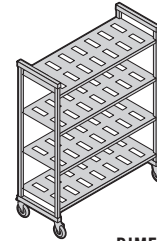

70¼"
HEIGHT

18"
DEPTH

CODE	DIMENSIONS D x L x H*	LIST PRICE EA.
EXMU183670V4	18" x 36" x 70¼"	\$ 890.00
EXMU184270V4	18" x 42" x 70¼"	965.00
EXMU184870V4	18" x 48" x 70¼"	985.00
EXMU185470V4	18" x 54" x 70¼"	1,050.00
EXMU186070V4	18" x 60" x 70¼"	1,105.00

21"
DEPTH

EXMU213670V4	21" x 36" x 70¼"	\$ 945.00
EXMU214270V4	21" x 42" x 70¼"	1,020.00
EXMU214870V4	21" x 48" x 70¼"	1,050.00
EXMU215470V4	21" x 54" x 70¼"	1,130.00
EXMU216070V4	21" x 60" x 70¼"	1,185.00

24"
DEPTH

EXMU243670V4	24" x 36" x 70¼"	\$ 965.00
EXMU244270V4	24" x 42" x 70¼"	1,030.00
EXMU244870V4	24" x 48" x 70¼"	1,080.00
EXMU245470V4	24" x 54" x 70¼"	1,145.00
EXMU246070V4	24" x 60" x 70¼"	1,190.00

78¼"
HEIGHT

18"
DEPTH

CODE	DIMENSIONS D x L x H*	LIST PRICE EA.
EXMU183678V4	18" x 36" x 78¼"	\$ 890.00
EXMU184278V4	18" x 42" x 78¼"	970.00
EXMU184878V4	18" x 48" x 78¼"	990.00
EXMU185478V4	18" x 54" x 78¼"	1,055.00
EXMU186078V4	18" x 60" x 78¼"	1,105.00

21"
DEPTH

EXMU213678V4	21" x 36" x 78¼"	\$ 945.00
EXMU214278V4	21" x 42" x 78¼"	1,025.00
EXMU214878V4	21" x 48" x 78¼"	1,055.00
EXMU215478V4	21" x 54" x 78¼"	1,135.00
EXMU216078V4	21" x 60" x 78¼"	1,190.00

24"
DEPTH

EXMU243678V4	24" x 36" x 78¼"	\$ 965.00
EXMU244278V4	24" x 42" x 78¼"	1,035.00
EXMU244878V4	24" x 48" x 78¼"	1,085.00
EXMU245478V4	24" x 54" x 78¼"	1,145.00
EXMU246078V4	24" x 60" x 78¼"	1,195.00

*Includes 5" casters.

CAMSHELVING ELEMENTS® XTRA SERIES

Corner Connectors

Unique clasp design ensures maximum shelf space utilization without loss of weight bearing in corners and increased weight bearing on middle shelves between units. Use 1 set per shelf to connect starter and add-on units in corners. Connect 4 or 5 intermediate shelves between 2 starter units (2 sets required per shelf).



CODE	DESCRIPTION	LIST PRICE EA.
EXCC1	1 Set for 1 shelf	\$ 13.80
EXCC4	4 Sets for 4 shelves	55.20
EXCC5	5 Sets for 5 shelves	69.00

Color: Speckled Gray (480).

Bottom Shelf Dunnage Stands

Increase weight bearing capacity on bottom shelf only. Add to any shelf length. Highly recommended for starter units 54" and longer and all corner units, intermediate units and units specified for heavier load volume on and off bottom shelves.

Bottom Shelf with Dunnage Stand

UNIT LENGTH	WEIGHT BEARING
Standard Unit	
24" - 48"	1,200 lbs.
54" - 72"	900
Corner Unit with 2 Dunnage Stands	
24" - 60"	1,200

CODE	DIMENSIONS D x H	LIST PRICE EA.
Dunnage Stand – Low (bottom shelf installed on lowest set of open post locations for dovetails)		
CSDS14H6	14" x 6½"	\$ 69.00
CSDS18H6	18" x 6½"	71.25
CSDS21H6	21" x 6½"	73.00
CSDS24H6	24" x 6½"	74.75

Dunnage Stand – Tall (bottom shelf installed up on 2nd set of open post locations for dovetails)		
CSDS14H10	14" x 10½"	\$ 75.25
CSDS18H10	18" x 10½"	77.50
CSDS21H10	21" x 10½"	79.25
CSDS24H10	24" x 10½"	81.00

Case Pack: 1 Color: Speckled Gray (480).

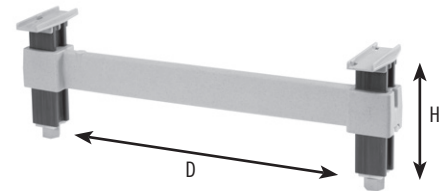

Shelf Traverses

Available in single or double packs. Use two traverses to add an open shelf for divider bars or drying cradles. Add one stationary traverse onto back posts of a stationary unit for extra support when placing rolling equipment under the first shelf. Traverse dovetails included.

LENGTH	SINGLE PACK CODE*	LIST PRICE EA.	DOUBLE PACK CODE**	LIST PRICE EA.
24"	EXTR24	\$ 36.90	EXTR242PK	\$ 70.50
30"	EXTR30	39.95	EXTR302PK	76.25
36"	EXTR36	41.55	EXTR362PK	79.25
42"	EXTR42	44.35	EXTR422PK	84.50
48"	EXTR48	48.35	EXTR482PK	92.25
54"	EXTR54	52.50	EXTR542PK	100.00
60"	EXTR60	56.50	EXTR602PK	108.00
72"	EXTR72	64.75	—	—

*Case Pack: 1 **Case Pack: 2
Color: Speckled Gray (480).



Elements XTRA Shelf Traverses covered by U.S. Patent D 989,612 S, 11,812,847 B2, 11,697,037 B2.

V4 4-Shelf Vented High Density Mobile Units

70¹/₄"
HEIGHT

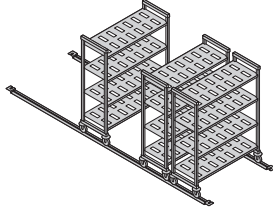

Units include 2 factory assembled mobile post kits,
8 traverses, shelf plates, 4 high density casters and
4 high density donut bumpers. Units ship complete in 1 box.

18"
DEPTH

CODE	DIMENSIONS D x L x H	LIST PRICE EA.
EXHD183670V4	18" x 36" x 70 ¹ / ₄ "	\$ 964.00
EXHD184270V4	18" x 42" x 70 ¹ / ₄ "	1,034.00
EXHD184870V4	18" x 48" x 70 ¹ / ₄ "	1,056.00
EXHD185470V4	18" x 54" x 70 ¹ / ₄ "	1,136.00
EXHD186070V4	18" x 60" x 70 ¹ / ₄ "	1,187.00

21"
DEPTH

EXHD213670V4	21" x 36" x 70 ¹ / ₄ "	1,024.00
EXHD214270V4	21" x 42" x 70 ¹ / ₄ "	1,114.00
EXHD214870V4	21" x 48" x 70 ¹ / ₄ "	1,144.00
EXHD215470V4	21" x 54" x 70 ¹ / ₄ "	1,232.00
EXHD216070V4	21" x 60" x 70 ¹ / ₄ "	1,292.00

24"
DEPTH

EXHD243670V4	24" x 36" x 70 ¹ / ₄ "	1,051.00
EXHD244270V4	24" x 42" x 70 ¹ / ₄ "	1,124.00
EXHD244870V4	24" x 48" x 70 ¹ / ₄ "	1,179.00
EXHD245470V4	24" x 54" x 70 ¹ / ₄ "	1,249.00
EXHD246070V4	24" x 60" x 70 ¹ / ₄ "	1,304.00

78¹/₄"
HEIGHT

18"
DEPTH

CODE	DIMENSIONS D x L x H	LIST PRICE EA.
EXHD183678V4	18" x 36" x 78 ¹ / ₄ "	\$ 978.00
EXHD184278V4	18" x 42" x 78 ¹ / ₄ "	1,048.00
EXHD184878V4	18" x 48" x 78 ¹ / ₄ "	1,101.00
EXHD185478V4	18" x 54" x 78 ¹ / ₄ "	1,180.00
EXHD186078V4	18" x 60" x 78 ¹ / ₄ "	1,237.00

21"
DEPTH

EXHD213678V4	21" x 36" x 78 ¹ / ₄ "	1,035.00
EXHD214278V4	21" x 42" x 78 ¹ / ₄ "	1,125.00
EXHD214878V4	21" x 48" x 78 ¹ / ₄ "	1,155.00
EXHD215478V4	21" x 54" x 78 ¹ / ₄ "	1,243.00
EXHD216078V4	21" x 60" x 78 ¹ / ₄ "	1,303.00

24"
DEPTH

EXHD243678V4	24" x 36" x 78 ¹ / ₄ "	1,062.00
EXHD244278V4	24" x 42" x 78 ¹ / ₄ "	1,135.00
EXHD244878V4	24" x 48" x 78 ¹ / ₄ "	1,190.00
EXHD245478V4	24" x 54" x 78 ¹ / ₄ "	1,260.00
EXHD246078V4	24" x 60" x 78 ¹ / ₄ "	1,135.00

S4 4-Shelf Solid High Density Mobile Units

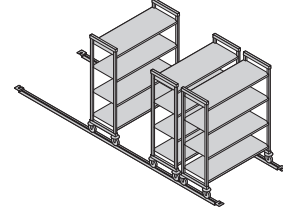

CODE	DIMENSIONS D x L x H	LIST PRICE EA.
EXHD183670S4	18" x 36" x 70 ¹ / ₄ "	\$ 980.00
EXHD184270S4	18" x 42" x 70 ¹ / ₄ "	1,056.00
EXHD184870S4	18" x 48" x 70 ¹ / ₄ "	1,087.00
EXHD185470S4	18" x 54" x 70 ¹ / ₄ "	1,166.00
EXHD186070S4	18" x 60" x 70 ¹ / ₄ "	1,223.00

EXHD213670S4	21" x 36" x 70 ¹ / ₄ "	1,051.00
EXHD214270S4	21" x 42" x 70 ¹ / ₄ "	1,139.00
EXHD214870S4	21" x 48" x 70 ¹ / ₄ "	1,184.00
EXHD215470S4	21" x 54" x 70 ¹ / ₄ "	1,264.00
EXHD216070S4	21" x 60" x 70 ¹ / ₄ "	1,328.00

EXHD243670S4	24" x 36" x 70 ¹ / ₄ "	1,078.00
EXHD244270S4	24" x 42" x 70 ¹ / ₄ "	1,159.00
EXHD244870S4	24" x 48" x 70 ¹ / ₄ "	1,209.00
EXHD245470S4	24" x 54" x 70 ¹ / ₄ "	1,293.00
EXHD246070S4	24" x 60" x 70 ¹ / ₄ "	1,349.00

CODE	DIMENSIONS D x L x H	LIST PRICE EA.
EXHD183678S4	18" x 36" x 78 ¹ / ₄ "	\$ 994.00
EXHD184278S4	18" x 42" x 78 ¹ / ₄ "	1,070.00
EXHD184878S4	18" x 48" x 78 ¹ / ₄ "	1,070.00
EXHD185478S4	18" x 54" x 78 ¹ / ₄ "	1,150.00
EXHD186078S4	18" x 60" x 78 ¹ / ₄ "	1,201.00

EXHD213678S4	21" x 36" x 78 ¹ / ₄ "	1,062.00
EXHD214278S4	21" x 42" x 78 ¹ / ₄ "	1,150.00
EXHD214878S4	21" x 48" x 78 ¹ / ₄ "	1,195.00
EXHD215478S4	21" x 54" x 78 ¹ / ₄ "	1,275.00
EXHD216078S4	21" x 60" x 78 ¹ / ₄ "	1,339.00

EXHD243678S4	24" x 36" x 78 ¹ / ₄ "	1,089.00
EXHD244278S4	24" x 42" x 78 ¹ / ₄ "	1,170.00
EXHD244878S4	24" x 48" x 78 ¹ / ₄ "	1,220.00
EXHD245478S4	24" x 54" x 78 ¹ / ₄ "	1,304.00
EXHD246078S4	24" x 60" x 78 ¹ / ₄ "	1,360.00