

# robot coupe®

**NEW**  
Register  
your product  
on line

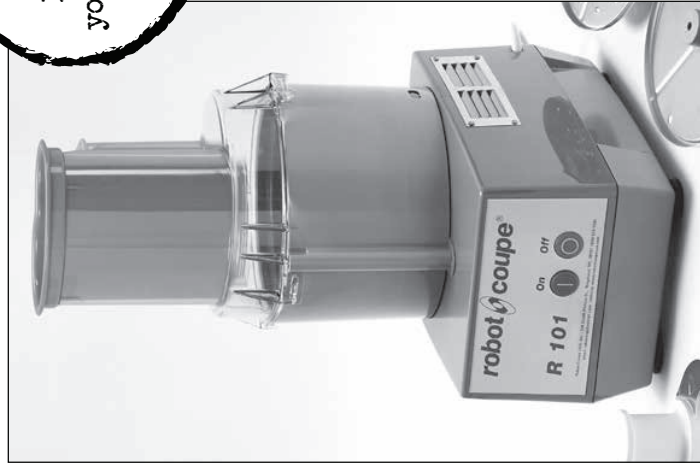

**R 100**



**R 101**



**R 101B**

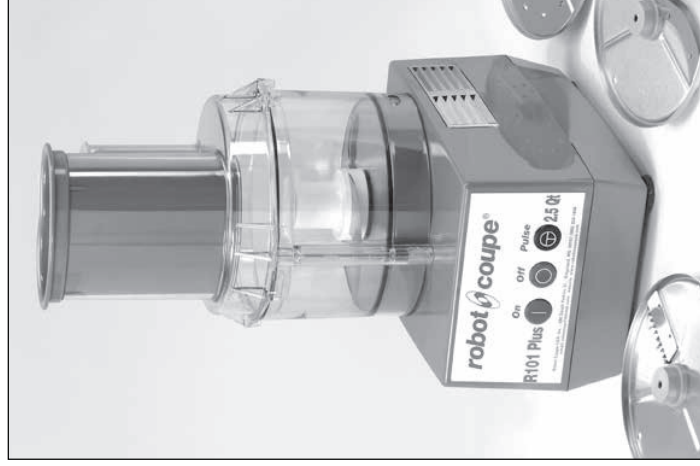

**R 101 Plus**

**Robot Coupe U.S.A., Inc.**

264 South Perkins, Ridgeland, MS 39157 - Phone : 800/824-1646 • 601/898-8411

email: [info@robotcoupeusa.com](mailto:info@robotcoupeusa.com) - website: [www.robot-coupe.com](http://www.robot-coupe.com)



www.robotcoupeusa.com

**robot coupe** CALL US NOW! 1-800-824-1646

English - USA | Español-USA | Français - QUEBEC | More...  
Parts Diagrams

CATALOG ▾ SELECTION GUIDE PRODUCT INFO VIDEOS OUR RECIPES CONTACT US SALES REF **SUPPORT** Search

Access to Part Diagrams **Register your product**

### Service Agencies

robot coupe HOME CATALOG SELECTION GUIDE PRODUCT INFO VIDEOS OUR RECIPES SUPPORT SITEMAP  
Log on Other languages

© All rights reserved, 2010.

## Register your product online

We reserve the right to alter at any time without notice the technical specifications of this appliance.  
None of the information contained in this document is of a contractual nature. Modifications may be made at any time.  
© All rights reserved for all countries by: **ROBOT-COUBE S.N.C.**

# IMPORTANT WARNING



**WARNING:** In order to limit accidents such as electric shocks or personal injury, and in order to limit material damage due to misuse of the appliance, please read these instructions carefully and follow them strictly. Reading the operating instructions will help you get to know your appliance and enable you to use the equipment correctly. Please read these instructions in their entirety and make sure that anyone else who may use the appliance also reads them beforehand. Our equipment is designed for professional use and must not be used by children under any circumstances.

## UNPACKING

- Carefully remove the equipment from the packaging and take out all the boxes or packets containing attachments or specific items.
- **WARNING** - some of the tools are very sharp e.g. blades, discs... etc..
- Store manuals, tools and spare parts in a safe place available to the users of the machine

## INSTALLATION

• This machine must be operated on a clean sturdy counter or table. Keep the area around and under the machine clear to allow air circulation. Otherwise the motor can overheat. All four feet must be in place.

## CONNECTION

- Always check that your power supply corresponds to that indicated on the identification plate on the motor unit and that it can withstand the amperage.
- The unit must always be connected to a grounded outlet with Ground Fault Circuit Interrupter (GFCI) protection device.
- Always check that the motor shaft rotates in counter clockwise direction before the blades are installed.

## HANDLING

- Always take care when handling the blades, as they are extremely sharp.
- Wear cut-proof gloves when handling the blades.

## USE

- The machine must not be modified in any way from its original configuration.
- Never tamper with, or defeat the purpose of the locking and safety systems.
- Do not put nonfood objects in the bowl.
- Do not leave the machine running unattended.
- The machine must be operated and stored in a location not subject to water drips or spray or explosive vapors.
- Should the machine malfunction or should any part be damaged, it must not be operated until it is repaired by a qualified technician using only genuine Robot Coupe repair parts.
- Failure to follow these operating instructions or attempts to operate the machine outside its design limits may create a hazardous condition that could damage the machine and/or injure users. Special attention should be given to the use of the operation controls and safety features.
- The unit is equipped with a thermal overload circuit-breaker. If the unit overheats due to an overload condition, it will automatically shut off. After cooling a few minutes the thermal overload circuit-breaker may be reset. Press the reset button located on the bottom left front of the unit.
- Operating times of 5 minutes or longer can cause processed food to increase to temperatures above 125° F (52° C).
- Maximum fill level is  $\frac{2}{3}$  full, less if the product is very dense or sticky.

## CLEANING

- As a precaution, always unplug your appliance before cleaning it.
- Always clean the appliance and its attachments at the end of each cycle.
- Never immerse the motor base in water.
- For parts made from aluminum, use metal safe detergents intended for aluminum.
- Caustic detergents used in automatic dishwashers quickly degrade plastic parts. Hand wash plastic parts if possible.
- Robot Coupe can in no way be held responsible for the user's failure to follow the basic rules of cleaning and hygiene.

## MAINTENANCE

- Do not open the motor housing. There are no user serviceable components inside the electrical housing. Refer control component repairs to qualified technicians.
- Replace seals every 3 to 6 months. Lubricate with food safe grease.
- It is particularly important to maintain and check the attachments since certain ingredients contain corrosive agents, e.g. citric acid.
- Never operate the appliance if the power cord or plug has been damaged or if the appliance fails to work properly or has been damaged in any way.
- If the machine malfunctions in any way discard any food being processed and refer service to qualified maintenance technicians.

# SUMMARY

## WARRANTY

## ACCESSORIES

## IMPORTANT WARNING

## CLEANING

- Attachments
- Motor base
- Blade and cutting plates

## INTRODUCTION TO YOUR NEW

R 100 • R 101 • R 101 B • R 101 Plus

## SWITCHING ON THE MACHINE

- Advice on electrical connections
- Control panel

## MAINTENANCE

- Blade and cutting plates
- Motor seal

## ASSEMBLY

- Bowl attachment
- Vegetable preparation attachment

## SAFETY

## SERVICE

## OPERATING INSTRUCTIONS

- Using the cutting blade
- Using the cutting plates

## TECHNICAL DATA

- Electrical and wiring diagrams

# ROBOT COUPE U.S.A., INC. ONE YEAR LIMITED COMMERCIAL WARRANTY

**YOUR NEW ROBOT COUPE COMMERCIAL PRODUCT IS WARRANTED TO THE ORIGINAL PURCHASER FOR A PERIOD OF ONE YEAR FROM THE DATE OF PURCHASE.**

**This LIMITED COMMERCIAL WARRANTY is against defects in the material and / or workmanship, and includes labor for replacement of defective parts, provided repairs are performed by an authorized service agency (see attached list). The CUSTOMER must inform the Service Agency of the possibility of warranty coverage and provide a copy of the dated sales or delivery receipt BEFORE WARRANTY REPAIRS ARE BEGUN. All parts or accessories replaced under warranty must be returned to the Service Agency. The warranty for work done or parts replaced under warranty expires at the end of the original warranty period.**

**Replacement parts and accessories are warranted for ninety (90) days from the date of purchase when purchased separately and will be verified by dated sales receipt OR packing slip which list that item.**

**All Robot Coupe Products are considered commercial use only.**

## **THE FOLLOWING ARE NOT COVERED UNDER WARRANTY:**

- 1 - Damage caused by abuse, misuse, dropping, or other similar incidental damage caused by or as result of failure to follow installation, assembly, operating, cleaning, user maintenance or storage instructions, including failure to verify and correct rotation of three phase motors.
- 2 - Labor to sharpen and/or parts to replace knife assemblies or blades which have become dull, chipped, or worn due to normal use.
- 3 - Material or labor to renew or repair scratched, stained, chipped, dented, or discolored surfaces, blades, knives, attachments, or accessories.
- 4 - Transportation charges to or from an authorized service agency for repairs of a machine designated as "CARRY IN SERVICE" (Table Top Models).
- 5 - Labor charges to install or test attachments or accessories (i.e. bowls, cutting plates, blades, attachments) which are replaced for any reason.
- 6 - Charges to change Direction-of-Rotation of Three Phase electric motors (INSTALLER IS RESPONSIBLE). All Robot Coupe products must operate counter-clock-wise.
- 7 - SHIPPING DAMAGE IS NOT COVERED BY WARRANTY. Visible and hidden damages are the responsibility of the freight carrier. The consignee must file a damage claim promptly against the carrier, or upon discovery in the case of hidden damage.
- 8 - Any ROBOT COUPE COMMERCIAL PRODUCT used in an Industrial application.

Commercial equipment use is defined as but not limited to the preparation of food substance within the confines of a restaurant/facility, that is sold and consumed within said restaurant/facility.

Industrial equipment use is defined as but not limited to the manufacturing of food substance in large batch quantities. The processed food is then packaged and sold off site and or to a distributor for resale off site.

**KEEP ALL ORIGINAL CONTAINERS AND PACKING MATERIALS FOR CARRIER INSPECTION**

All Robot Coupe equipment should be operated in an ambient room temperature of 60 degrees (F) or higher.

Robot Coupe U.S.A., Inc., Robot Coupe S.A., or any of their affiliates, distributors, officers, directors, agents, employees or insurers will not be obligated for consequential or other damages, losses, or expenses in connection with or by reason of the use of or the inability to use the machine for any purpose.

**THIS WARRANTY IS GIVEN EXPRESSLY AND IN LIEU OF ALL OTHER WARRANTIES EXPRESSED OR IMPLIED, FOR MERCHANTABILITY AND FOR FITNESS TOWARD A PARTICULAR PURPOSE AND CONSTITUTES THE ONLY WARRANTY MADE BY ROBOT COUPE, U.S.A., Inc.**

# IMPORTANT WARNING



**WARNING:** In order to limit accidents such as electric shocks or personal injury, and in order to limit material damage due to misuse of the appliance, please read these instructions carefully and follow them strictly. Reading the operating instructions will help you get to know your appliance and enable you to use the equipment correctly. Please read these instructions in their entirety and make sure that anyone else who may use the appliance also reads them beforehand. Our equipment is designed for professional use and must not be used by children under any circumstances.

## UNPACKING

- Carefully remove the equipment from the packaging and take out all the boxes or packets containing attachments or specific items.
- **WARNING** - some of the tools are very sharp e.g. blades, discs... etc..
- Store manuals, tools and spare parts in a safe place available to the users of the machine

## INSTALLATION

- This machine must be operated on a clean sturdy counter or table. Keep the area around and under the machine clear to allow air circulation. Otherwise the motor can overheat. All four feet must be in place.

## CONNECTION

- Always check that your power supply corresponds to that indicated on the identification plate on the motor unit and that it can withstand the amperage.
- The unit must always be connected to a grounded outlet with Ground Fault Circuit Interrupter (GFCI) protection device.
- Always check that the motor shaft rotates in counter clockwise direction before the blades are installed.

## HANDLING

- Always take care when handling the blades, as they are extremely sharp.
- Wear cut-proof gloves when handling the blades.

## USE

- The machine must not be modified in any way from its original configuration.
- Never tamper with, or defeat the purpose of the locking and safety systems.
- Do not put nonfood objects in the bowl.
- Do not leave the machine running unattended.
- The machine must be operated and stored in a location not subject to water drips or spray or explosive vapors.
- Should the machine malfunction or should any part be damaged, it must not be operated until it is repaired by a qualified technician using only genuine Robot Coupe repair parts.
- Failure to follow these operating instructions or attempts to operate the machine outside its design limits may create a hazardous condition that could damage the machine and/or injure users. Special attention should be given to the use of the operation controls and safety features.
- The unit is equipped with a thermal overload circuit-breaker. If the unit overheats due to an overload condition, it will automatically shut off. After cooling a few minutes the thermal overload circuit-breaker may be reset. Press the reset button located on the bottom left front of the unit.
- Operating times of 5 minutes or longer can cause processed food to increase to temperatures above 125° F (52° C).
- Maximum fill level is  $\frac{2}{3}$  full, less if the product is very dense or sticky.

## CLEANING

- As a precaution, always unplug your appliance before cleaning it.
- Always clean the appliance and its attachments at the end of each cycle.
- Never immerse the motor base in water.
- For parts made from aluminum, use metal safe detergents intended for aluminum.
- Caustic detergents used in automatic dishwashers quickly degrade plastic parts. Hand wash plastic parts if possible.
- Robot Coupe can in no way be held responsible for the user's failure to follow the basic rules of cleaning and hygiene.

## MAINTENANCE

- Do not open the motor housing. There are no user serviceable components inside the electrical housing. Refer control component repairs to qualified technicians.
- Replace seals every 3 to 6 months. Lubricate with food safe grease.
- It is particularly important to maintain and check the attachments since certain ingredients contain corrosive agents, e.g. citric acid.
- Never operate the appliance if the power cord or plug has been damaged or if the appliance fails to work properly or has been damaged in any way.
- If the machine malfunctions in any way discard any food being processed and refer service to qualified maintenance technicians.

## INTRODUCTION TO YOUR NEW R 100 • R 101 • R 101 B • R 101 Plus

The R 100, R 101, R 101B and R 101 Plus is a versatile machine designed to meet your professional needs. It can perform a number of tasks, as well as save much in time and labor.

This food processor consists of a bowl assembly and a vegetable preparation lid that ejects into the bowl. The 2.5 quart bowl is used for chopping, grinding, pureeing, blending, mixing, and kneading of ingredients required in most every recipe.

A wide range of cutting plates is available for use with the vegetable preparation attachment. Cutting plates are available for slicing, wavy slicing, grating, pulping, and julienne.

Its numerous functions will open the door to a whole new culinary world.

Thanks to its simple design, all components requiring frequent handling for maintenance or cleaning can be easily assembled and removed.

All users should read this operation manual before operating the machine.

## SWITCHING ON THE MACHINE

### • ADVICE ON ELECTRICAL CONNECTIONS

Before plugging in, check that your power supply corresponds to that indicated on the machine's serial number plate.



## WARNING

**This appliance must be plugged into an grounded socket (risk of electrocution).**

## • CONTROL PANEL



### R 100 / R 101

Red switch = Off switch  
Green switch = On switch

### R 101 B / R 101 Plus

Red switch = Off switch  
Green switch = On switch  
Black switch = Pulse switch

R 101 Plus also available with a grey bowl.



2) Then, turn the bowl back to the right. The safety switch pin should come to a stop at the front of the motor base. The bowl, when properly assembled, should be just off and level with the top surface of the motor base assembly.

3) Place the blade onto the motor shaft. Rotate the blade until it drops into place.

The bottom blade should be level with, and just off the bottom of the bowl.



4) Press the off button in case the machine was left turned on.

Place the lid on the bowl so that the large feed-hopper is facing you. Rotate to the right until it locks.

The machine is now assembled and ready for use.

## ASSEMBLY

### • BOWL ATTACHMENT



1) With the motor base facing you, place the bowl onto the motor base with the pin toward the front. Turn the bowl just off-center and to the left as you lower it onto the base.

### • VEGETABLE PREPARATION ATTACHMENT

Follow the same procedure as for the cutter attachment for points 1) and 2).



3) With the metal pin side up, place the plate support on the motor shaft. Rotate the plate support until it falls into place on the motor shaft.



4) Put the cutting plate of your choice on the motor shaft. Rotate the plate until it falls into place on the plate support.



5) Press the off button in case the machine was left turned on.

Place the lid on the bowl so that the large feed-hopper is facing you. Close the lid by rotating to the right until it locks.



**REMEMBER:**

R 101 B is delivered as a bowl cutter mixer only (no vegetable preparation attachment)

**OPERATING INSTRUCTIONS**

**THE UNIT SHOULD BE OFF EXCEPT WHEN PROCESSING IS UNDERWAY.**

It is recommended that the machine be operated on a 50% duty cycle. This is easily accomplished since the preparation time (cleaning, coring, peeling, and loading) takes longer than the processing time. This will yield the longest life for your machine.

**• USING THE CUTTING BLADE**

The blade is used for grinding, kneading, pureeing, blending, mixing, and emulsifying. Before placing the product in the bowl some products such as meats and cheeses should be precut into 1-2 inch portions. When filling the bowl, allow space above the product for circulation.

There are two ways to run your machine: Chopping, using a pulse or start/stop action with the on/off switches (use the pulse button on the R 101 B and R 101 Plus), or running continuously for a fine chop or puree. To obtain a uniform chop of products such as meats and cheeses, begin with a uniformly portioned product. Pulse the machine until the desired result is reached. Then, if a puree or fine chop is desired, press the on button, and allow the machine to run until the product is the right consistency.

<b>• FISH</b>			
Brandade		2 ¼	5
Terrines		2 ¼	5
<b>• VEGETABLES</b>			
Garlic/parsley/ onion/shallots		½ / 1	3
Soup / purées		2 ¼	4
<b>• FRUIT</b>			
Compotes / purées		2 ¼	4
<b>EMULSIFY</b>			
Mayonnaise / ailoli / remoulade sauce		2 ¼	3
Snail or salmon butter		1 ¼	4
<b>KNEAD</b>			
Shortcrust pastry/shortbread		2	4
Pizza dough		2	4
<b>GRIND</b>			
Dried fruit		1	4
Parsley		1	4
Breadcrumbs		1	5

The cutter version has numerous other applications. The above quantities and times are approximate and may vary according to the quality of the ingredients and recipes.

**• USING THE CUTTING PLATES**

The vegetable preparation attachment is used for slicing, grating, wavy slicing, julienne, and pulping.

The vegetable preparation attachment consists of two feed openings :

- one large feed opening for cutting vegetables such as cabbage, celeriac, etc.
- a small feed opening for long vegetables and high-precision cutting.





<b>USES</b>	Max. processing quantity (in pounds)	Processing time (in mm)
<b>• MEAT</b>		
Hamburgers/steak tartare	1 ¾	3
Sausage meat/tomatoes	1 ½	3
Terrine/pâté	1 ½	4

**Do not attempt to run frozen products through the cutting plates.**

**Do not put anything other than food products into the feed openings.**

**Do not remove attachments while the motor is running.**

**Do not apply excess pressure to the food pushers: This can cause damage to the motor and other parts.**

	<b>SLICERS</b>	
3/64	carrot / cabbage / cucumber / onion / potato / leek	
5/64 - 1/8	lemon / carrot / mushroom / cabbage / potato / cucumber / zucchini / onion / leek / bell pepper	
5/32 - 3/16	eggplant / beet root / carrot / mushroom / cucumber / bell pepper / radish / lettuce / potato / leek / tomato	
1/4	eggplant / beet root / carrot / mushroom / cucumber / bell pepper / radish / lettuce / potato / leek	
	<b>RIPPLE CUT SLICER</b>	
5/64	beet root / potato / carrot	
	<b>GRATERS</b>	
1/16	celeriac / cheese	3/8 cabbage/cheese
5/64	carrot / celeriac / cheese	Hard cheese
1/8	carrot	1/32 Extrafine
1/4	cabbage / cheese	3/64 Pulping
	<b>JULIENNE</b>	
5/64 x 5/64	carrot / celeriac / potato	
5/64 x 5/32	carrot / beet root / zucchini / potato	
5/64 x 1/4	carrot / beet root / zucchini / potato	
5/32 x 5/32	eggplant / beet root / zucchini / potato	
1/4 x 1/4	eggplant / beet root / celeriac / zucchini / potato	
5/16 x 5/16	celeriac / potato	

## ACCESSORIES



A **coarse serrated blade** is available as an option and is mainly intended for kneading and grinding.



A **fine serrated blade** is available mainly for use in chopping parsley. The blade edge is longer lasting than the smooth blade but cannot be sharpened.

We advise you to use this blade mainly to chop parsley.

## CLEANING



### WARNING

**As a precaution, always unplug your appliance before cleaning it (risk of electric shock).**

### • ATTACHMENTS

Remove all attachments before cleaning. The bowl and lid attachments should be cleaned per the following instructions or as required by local health department regulations.

**CLEAR PLASTIC BOWLS:** Some models, such as the R 101 Plus, are shipped with a clear plastic bowl.

**NEVER CLEAN CLEAR PLASTIC BOWLS WITH CLORINE.**

The bowl, blade, lid, pushers, and plates are dishwasher safe. All of the attachments listed above can be washed in a dish machine or three-tank system pot sink.

Pre-rinse the attachments before washing to remove any bulk food on the parts.

A stiff bristle brush or power sprayer faucet attachment is effective in knocking the food out of the crevices as a pre-rinse procedure.

The washer should have an industry standard wash, rinse and sanitization cycle. Allow the parts to air dry after sanitizing and before reassembly.

**NOTE: The high temperatures of dish machines will tend to shorten the life of the plastic and rubber parts.**

**Hand washing using a three-pot sink will provide for the longest life of these parts.**

**Wear cut-resistant gloves when cleaning the blade and plates.**

Clean the outside of the bowl, the lid, and around the switch pin to ensure they are clean. Use a brush on these areas if necessary.

### • MOTOR BASE

Cleaning of the motor base assembly must be done with care. The motor base contains the electrical components.

**NEVER IMMERS THE MOTOR BASE ASSEMBLY IN WATER.**

**First, unplug the power cord.** Wipe down the motor base using a cloth lightly dampened (not dripping) with water, then with a sanitizing solution, and dry the machine with a soft cloth removing all liquids from the seal area. Do not allow water to penetrate the shaft seal or around the switches. Clean around the shaft seal with a small brush, taking care to remove all food. Do not forget to clean the motor shaft.

## • BLADE AND CUTTING PLATES

Handle the blades and cutting plates with caution to prevent cuts. A stiff, long handled, bristle brush can be a very effective tool for cleaning the blade and cutting plates.

### IMPORTANT

Check that your detergent is suitable for cleaning plastic parts. Some washing agents are too alkaline (e.g. high levels of caustic soda or ammonia) and totally incompatible with certain types of plastic, causing them to deteriorate rapidly.

## MAINTENANCE

### • BLADE AND CUTTING PLATES

Blades should be kept sharp. It is not necessary to have a razor edge. However, they will need sharpening periodically. Replacement of the dull blades or plates is recommended.

### • MOTOR SEAL

An examination should be made periodically to assure that a seal against liquids is being maintained around the motor shaft. With proper care, and depending on use, the seal should last for a year or more. However, it can and should be replaced whenever wear or erosion is noted, or minimally once every three to six months. It is recommended that the seal be replaced by an authorized repair agency.

## SAFETY

To avoid splashing when running liquids in the bowl, allow the blades to completely stop before opening the lid.

### WARNING

THE BLADES ARE EXTREMELY SHARP.  
HANDLE WITH CARE.

The R 100, R 101, R 101B and R 101 Plus are fitted with a mechanical safety switch that causes the machine to turn off when the lid is removed. If this safety feature should ever fail, remove the machine from use and have the machine repaired by your service agency.

**NOTE:** The machines are equipped with a **thermal protector** which automatically stops the motor if the machine is left on for too long or overloaded. If this happens, allow the machine to cool completely before restarting.

### REMEMBER

Never try to override or defeat the purpose of the locking and safety systems.

Never put nonfood objects into the machine openings.

Only use the food pushers to push the food into the machine.

Do not overload the appliance.

Never leave the machine running unattended.

## SERVICE

See warranty first then;

Should your unit require service, check with your distributor to see where local service is available. If not or if you wish your unit to be serviced at the factory, call for return instructions and ship the unit prepaid to our factory address.

PH : 1-800-824-1646

Robot-Coupe USA, Inc  
Service Department Repair  
264 South Perkins Street  
Ridgeland, MS 39157

For service in Canada contact the Robot-Coupe USA factory for repair instructions.

**robot**  **coupe**<sup>®</sup>

**TECHNICAL DATA**

# MODEL R 101 Plus - R 101 B - R 121

120V/60Hz SINGLE PHASE

## ELECTRIC DIAGRAM

## ESQUEMA CONEXIONES SCHEMA ELECTRIQUE

- R 101 Plus Serial # : from 636XXXXX 03 E - MM
- R 101 B Serial # : from 639XXXXX 03 E - MM
- R 121 Serial # : from 641XXXXX 03 F - MM

English	Espanol	Français
CD Starting capacitor	Condensador d'arranque	Condensateur de démarrage
EA Starting phase	Fase auxiliar	Phase auxiliaire
EP Main phase	Fase principale	Phase principale
KD Starting relay	Rele d'arranque	Relais de démarrage
MA ON / OFF - PULSE switch	Interruptor MARCHA / PARADA / IMPULSO	Interrupteur MARCHÉ / ARRÊT / PULSE
MO Single phase Motor	Motor monofasico	Moteur monophasé
PTO Motor thermal protector	Protector termico del motor	Protecteur thermique du moteur
SW Lid safety switch	Interruptor de seguridad cojinet	Interrupteur sécurité couvercle

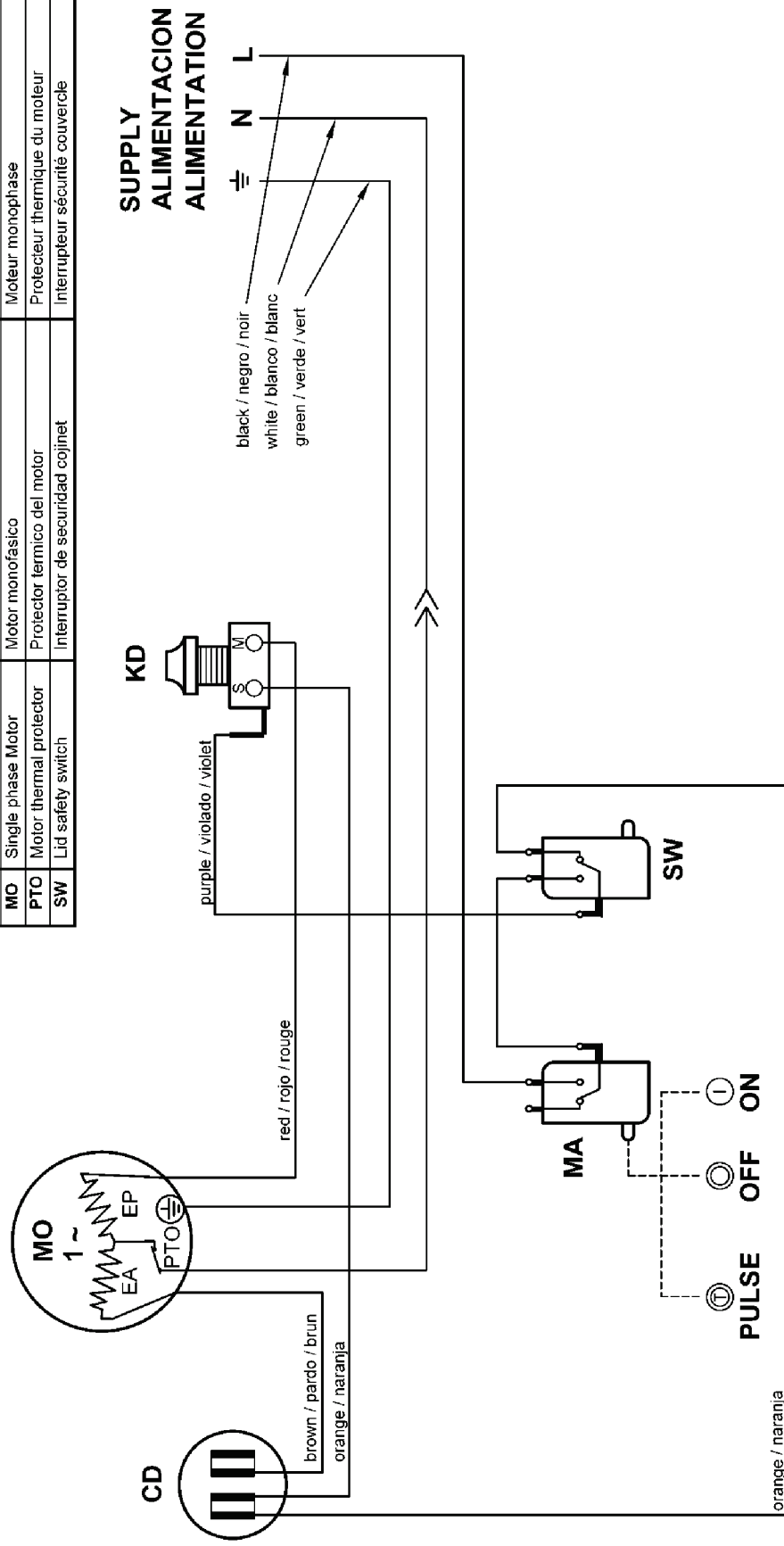

robotcoupe®

N° 410345

C : 10/11





# robot coupe®

**Robot Coupe U.S.A., Inc.,**

Phone: 800/824-1646 • 601/898-8411  
264 South Perkins St., Ridgeland, MS 39157

e-mail: [info@robotcoupeusa.com](mailto:info@robotcoupeusa.com)  
website: [www.robot-coupe.com](http://www.robot-coupe.com)

