

robot *coupe*®

New
Register
your product
on line

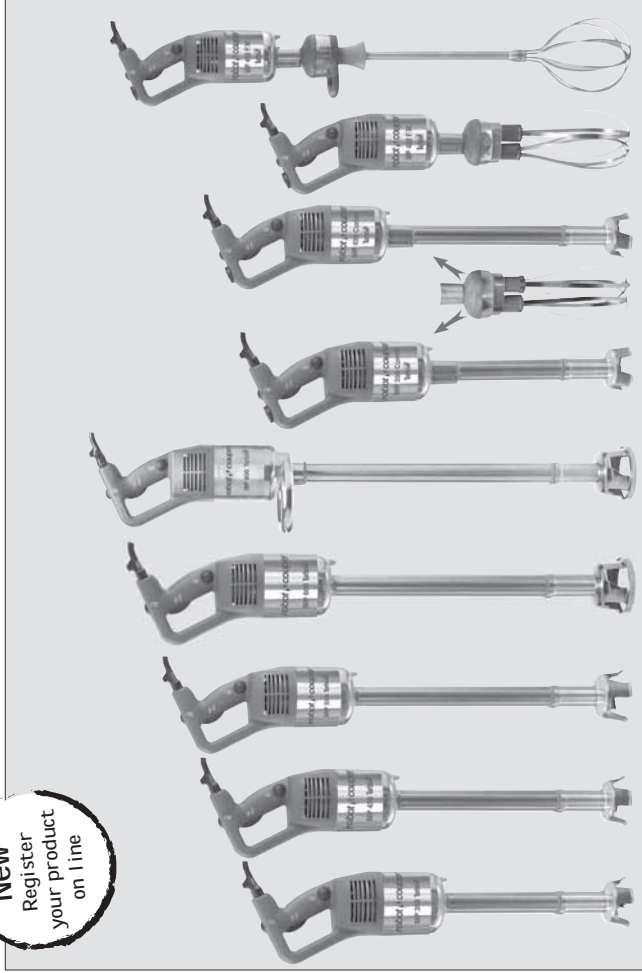

- MP 350 Turbo
- MP 350 Turbo V.V.
- MP 450 Turbo
- MP 450 Turbo V.V.
- MP 550 Turbo
- MP 600 Turbo
- MP 800 Turbo
- MP 350 Turbo Combi
- MP 450 Turbo Combi
- MP 450 Turbo FW
- MP 450 Turbo FW XL

Robot Coupe U.S.A., Inc.

264 South Perkins, Ridgeland, MS 39157

Phone: 800/824-1646 • 601/898-8411

email: info@robotcoupeusa.com - website: www.robot-coupe.com

03/11/2022

IMPORTANT WARNING



WARNING: In order to limit accidents such as electric shocks or personal injury, and in order to limit material damage due to misuse of the appliance, please read these instructions carefully and follow them strictly. Reading the operating instructions will help you get to know your appliance and enable you to use the equipment correctly. Please read these instructions in their entirety and make sure that anyone else who may use the appliance also reads them beforehand. Our equipment is designed for professional use and must not be used by children under any circumstances.

UNPACKING

- Carefully remove the equipment from the packaging and take out all the boxes or packets containing attachments or specific items.
- **WARNING - some of the tools are very sharp e.g. blades, discs... etc..**
- Store manuals, tools and spare parts in a safe place available to the users of the machine

CONNECTION

- Always check that your power supply corresponds to that indicated on the identification plate on the motor unit and that it can withstand the amperage.
- The unit must always be connected to a grounded outlet with Ground Fault Circuit Interrupter (GFCI) protection device.

HANDLING

- Always take care when handling the blades, as they are extremely sharp.
- Wear cut-proof gloves when handling the blades.

06/11/2022

USE

- The machine must not be modified in any way from its original configuration.
- Never tamper with, or defeat the purpose of the locking and safety systems.
- Do not leave the machine running unattended.
- The machine must be operated and stored in a location not subject to water drips or spray or explosive vapors.
- Should the machine malfunction or should any part be damaged, it must not be operated until it is repaired by a qualified technician using only genuine Robot Coupe repair parts.
- Failure to follow these operating instructions or attempts to operate the machine outside its design limits may create a hazardous condition that could damage the machine and/or injure users. Special attention should be given to the use of the operation controls and safety features.

CLEANING

- As a precaution, always unplug your appliance before cleaning it.

- Always clean the appliance and its attachments at the end of each cycle.
- Never immerse the motor base in water.
- For parts made from aluminum, use metal safe detergents intended for aluminum.
- Causitic detergents used in automatic dishwashers quickly degrade plastic parts. Hand wash plastic parts if possible.
- Robot Coupe can in no way be held responsible for the user's failure to follow the basic rules of cleaning and hygiene.

MAINTENANCE

- Do not open the motor housing. There are no user serviceable components inside the electrical housing. Refer control component repairs to qualified technicians.
- It is particularly important to maintain and check the attachments since certain ingredients contain corrosive agents, e.g. citric acid.
- Never operate the appliance if the power cord or plug has been damaged or if the appliance fails to work properly or has been damaged in any way.



www.robotcoupeusa.com

robot coupe
CALL US NOW!
1-800-834-1848

CATALOG • SELECTION GUIDE • PRODUCT INFO • VIDEOS • OUR RECIPES • CONTACT US • SALES REF • SUPPORT

English - USA | English - USA | Français - QUÉBEC | More...
Part Diagrams
Q Search
Access to Part Diagrams

Service Agencies

Register your product

robot coupe
HOME CATALOG SELECTION GUIDE PRODUCT INFO VIDEOS OUR RECIPES SUPPORT SITE MAP
Log in | Other languages

© All rights reserved, 2010.

Register your product online

We reserve the right to alter at any time without notice the technical specifications of this appliance.
None of the information contained in this document is of a contractual nature. Modifications may be made at any time.
© All rights reserved for all countries by: ROBOT-COUPÉ S.N.C.

CONTENTS

■ WARRANTY

■ IMPORTANT WARNING

- Unpacking
- Storage
- Power supply
- Specifications
- Dimensions
- Safety features
- Warning

■ INTRODUCTION TO YOUR NEW IMMERSION BLENDER

■ OPERATING THE IMMERSION BLENDER

- Operation
- Continuous operation
- Variable-speed operation
- Mashed potatoes function
- Power cord

■ WORKING POSITION

- Function blade
- Function whisk

■ ASSEMBLY & DISASSEMBLY

- Function blade
- Function whisk
- Mixing tool function

■ CLEANING

- Motor housing
- Tube and bell
- Blade
- Aluminum
- Plastic
- Whisk gearbox
- Whisks
- Mixing tool housing
- Mixing tool

■ MAINTENANCE

- Blade
- Whisks
- Power cord
- Tube Seal
- Seal Ring
- Cartridge

■ TROUBLE SHOOTING

■ SERVICE

■ ELECTRICAL AND WIRING DIAGRAMS

ROBOT COUPE U.S.A., INC. ONE YEAR LIMITED COMMERCIAL WARRANTY

YOUR NEW ROBOT COUPE COMMERCIAL PRODUCT IS WARRANTED TO THE ORIGINAL PURCHASER FOR A PERIOD OF ONE YEAR FROM THE DATE OF PURCHASE.

This LIMITED COMMERCIAL WARRANTY is against defects in the material and / or workmanship, and includes labor for replacement of defective parts, provided repairs are performed by an authorized service agency (see attached list). The CUSTOMER must inform the Service Agency of the possibility of warranty coverage and provide a copy of the dated sales or delivery receipt BEFORE WARRANTY REPAIRS ARE BEGUN. All parts or accessories replaced under warranty must be returned to the Service Agency. The warranty for work done or parts replaced under warranty expires at the end of the original warranty period.

Replacement parts and accessories are warranted for ninety (90) days from the date of purchase when purchased separately and will be verified by dated sales receipt OR packing slip which list that item.

All Robot Coupe Products are considered commercial use only.

THE FOLLOWING ARE NOT COVERED UNDER WARRANTY:

- 1 - Damage caused by abuse, misuse, dropping, or other similar incidental damage caused by or as result of failure to follow installation, assembly, operating, cleaning, user maintenance or storage instructions, including failure to verify and correct rotation of three phase motors.
- 2 - Labor to sharpen and/or parts to replace knife assemblies or blades which have become dull, chipped, or worn due to normal use.
- 3 - Material or labor to renew or repair scratched, stained, chipped, dented, or discolored surfaces, blades, knives, attachments, or accessories.
- 4 - Transportation charges to or from an authorized service agency for repairs of a machine designated as "CARRY IN SERVICE" (Table Top Models).
- 5 - Labor charges to install or test attachments or accessories (i.e. bowls, cutting plates, blades, attachments) which are replaced for any reason.
- 6 - Charges to change Direction-of-Rotation of Three Phase electric motors (INSTALLER IS RESPONSIBLE). All Robot Coupe products must operate counter-clock-wise.
- 7 - SHIPPING DAMAGE IS NOT COVERED BY WARRANTY. Visible and hidden damages are the responsibility of the freight carrier. The consignee must file a damage claim promptly against the carrier, or upon discovery in the case of hidden damage.
- 8 - Any ROBOT COUPE COMMERCIAL PRODUCT used in an Industrial application.

Commercial equipment use is defined as but not limited to the preparation of food substance within the confines of a restaurant/facility, that is sold and consumed within said restaurant/facility.

Industrial equipment use is defined as but not limited to the manufacturing of food substance in large batch quantities. The processed food is then packaged and sold off site and or to a distributor for resale off site.

KEEP ALL ORIGINAL CONTAINERS AND PACKING MATERIALS FOR CARRIER INSPECTION

All Robot Coupe equipment should be operated in an ambient room temperature of 60 degrees (F) or higher.

Robot Coupe U.S.A., Inc., Robot Coupe S.A., or any of their affiliates, distributors, officers, directors, agents, employees or insurers will not be obligated for consequential or other damages, losses, or expenses in connection with or by reason of the use of or the inability to use the machine for any purpose.

THIS WARRANTY IS GIVEN EXPRESSLY AND IN LIEU OF ALL OTHER WARRANTIES EXPRESSED OR IMPLIED, FOR MERCHANTABILITY AND FOR FITNESS TOWARD A PARTICULAR PURPOSE AND CONSTITUTES THE ONLY WARRANTY MADE BY ROBOT COUPE, U.S.A., Inc.

IMPORTANT WARNING

WARNING
KEEP THESE INSTRUCTIONS IN A SAFE PLACE

WARNING: In order to limit accidents such as electric shocks, personal injury or fire, and in order to limit material damage due to misuse of the appliance, please read these instructions carefully and follow them strictly. Reading the operating instructions will help you get to know your appliance and enable you to use the equipment correctly. The operation manual should be kept within easy access to all users for reference and should be read completely by all first time users of the machine. Our equipment is designed for professional use and must not be used by children under any circumstances.

UNPACKING

- Carefully remove the equipment from the packaging and take out all the boxes or packets containing attachments or specific items.
- Warning- Some parts are very sharp e.g.blade.Wear cutting gloves when handling the blade.**

STORAGE

- You are advised to install the wall bracket provided with the machine and to store your Immersion Blender on it. Hang the Immersion Blender with the motor unit UP.

POWER SUPPLY

- Connect the Immersion Blender to 110-120 Volt 60 Hz Power supply.
- Connect the Immersion Blender only to Ground Fault Interrupt (GFI) Safety type outlet.
- Do not connect the Immersion Blender with extension type power cord.
- GFI type outlets protect the machine from expensive damage and protect the operator from serious injury or death.

SPECIFICATIONS

- MP 350 Turbo - 120V/60Hz / 5,5 Amp. "Series C"
- MP 450 Turbo - 120V/60Hz / 6 Amp. "Series C"
- MP 550 Turbo - 120V/60Hz / 7 Amp. "Series C"
- MP 600 Turbo - 120V/60Hz / 7,7 Amp. "Series C"
- MP 800 Turbo - 120V/60Hz / 8,3 Amp. "Series C"
- MP 350 Turbo V.V. "Series C" • MP 350 Turbo Combi "Series C" - 120V/60Hz / 5,5 Amp.
- MP 450 Turbo V.V. "Series C" • MP 450 Turbo Combi "Series C" • MP 450 Turbo FW "Series C" • MP 450 Turbo FW XL "Series C" - 120V/60Hz / 6 Amp.

DIMENSIONS (In Inches)

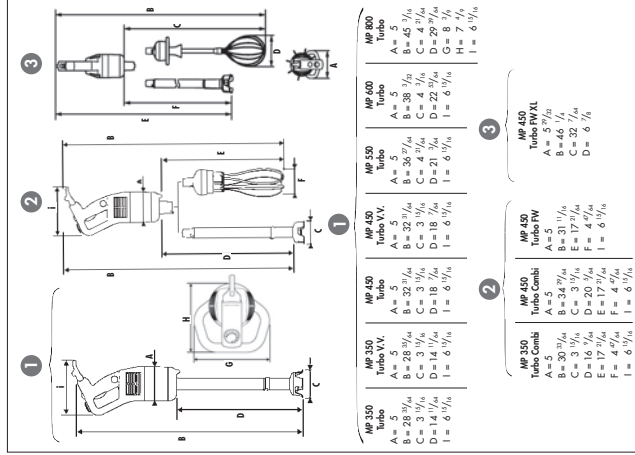

Blade Attachment Capacities

- Thanks to a very powerful motor, the MP 350 Turbo can process up to 50 quarts, the MP 450 Turbo up to 100 quarts, the MP 550 Turbo up to 200 quarts, the MP 600 Turbo up to 300 quarts and the MP 800 Turbo up to 400 quarts. The quality of the finished product is outstanding.

Whisk Attachment Capacities

- Using the whisk attachment all three models process from 2 to 50 egg whites and 30 kg of mashed potatoes or 60 litre of industrial puree.
- When the mixing tool attachment (FW XL) is used, the MP 450 FW XL can make up to 300 quarts of food preparation.

SAFETY FEATURES

- Safety on Control Switches:** This safety mechanism prevents any unintentional starting of the Immersion Blender. Two buttons must be pressed to start the Immersion Blender. See section "ON OPERATING THE IMMERSION BLENDER" (page 6).
- Safeties on motor thermal protection:** If the machine is overused, the thermal protection will stop the unit. In this case, wait for the unit to cool down (a period of up to 30 minutes) before restarting and proceed to the steps of "OPERATING THE IMMERSION BLENDER" (page 6).
- No volt release safety (Supply failure):** If there is a power failure or the machine is unplugged, the Immersion Blender will not restart by itself. See section "ON OPERATING THE IMMERSION BLENDER" (page 6).
- Safeties on motor overload protection:** If there is an obstruction in the container (a spoon or utensil) or the machine is overused and becomes hot, the unit will stop. This stop indicates that the preparation is too thick or is not adapted for a Immersion Blender. To restart the machine, see section "ON OPERATING THE IMMERSION BLENDER" (page 6).

INTRODUCTION TO YOUR NEW IMMERSION BLENDER

Robot-Coupe has developed a complete line of Immersion Blenders. The features of each are described in the table below.

| Models | Variable Speed | Blade attachment | Whisk attachment | Mixing tool attachment |
|--------------------|----------------|------------------|------------------|------------------------|
| MP 350 Turbo | | • | | |
| MP 350 Turbo V.V. | • | • | | |
| MP 450 Turbo | | • | | |
| MP 450 Turbo V.V. | • | • | | |
| MP 550 Turbo | | • | | |
| MP 600 Turbo | | • | | |
| MP 800 Turbo | | • | | |
| MP 350 Turbo Cambi | | • | • | |
| MP 450 Turbo Cambi | | • | • | |
| MP 450 Turbo FW | | • | | |
| MP 450 Turbo FW XL | | • | | • |

The Robot-Coupe Immersion Blenders perform a host of culinary feats. The blade attachment will allow you to make soups, vegetable purees and pulps while the **whisk attachment** is ideal for making pancake batter, mayonnaise, beaten egg whites, chocolate mousse, butter sauces, whipped cream or smooth fromage frais.

The mixing tool attachment (FW XL) is used to blend and homogenise very light preparations such as purees and soups made with dehydrated flakes and sauce + spice mixes.

It is not designed to make pasta or thick purees. The **variable speed function** will enable you to adjust the speed to suit each preparation and to start the processing at a lower speed in order to reduce splashing.

The Immersion Blender is easily assembled and disassembled for maintenance and cleaning.

OPERATING THE IMMERSION BLENDER

• OPERATION (valid for all models)

The Immersion Blender is equipped with electrical current and temperature overload protection. If the Immersion Blender stops unexpectedly you may try to restart it by following steps 3-5 below. If the Immersion Blender does not restart, allow it to cool for a period of up to 30 minutes and the temperature overload will automatically reset. You should then be able to restart following steps 3-5 below.

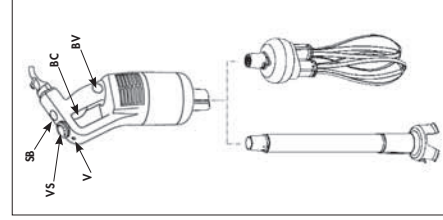

1. Check that the control button (CB) is in the released position.
2. Connect the cord to the power supply.
3. Put the tube into the product **with the bell completely immersed**.
4. Press and hold down the safety button (SB).
5. Press the control button (CB). The Immersion Blender starts working and the green "ON" indicator (V) lights up.
6. Release the safety button (SB).
7. To stop the Immersion Blender, release the control button (CB), the green "ON" indicator (V) goes off.

• CONTINUOUS OPERATION (valid for all models)

8. Follow steps 1-6 above, then: While the control button (CB) is pressed, press the locking button (LB).
9. Release the control button (CB).

10. Release the locking button (LB). The Immersion Blender then starts working by itself (the green "ON" indicator (V) lights up).

11. To stop the Immersion Blender, press and release the control button (CB). The green "ON" indicator (V) goes off.

• VARIABLE-SPEED OPERATION

Follow steps 1 to 6 above, then change the speed of the motor by turning the button (VS) toward the maximum or minimum as required.

It is advisable to start at a low speed when using the whisk.

Principle of automatic speed regulation: Once you have selected the right speed, allow the Immersion Blender to run on its own. The speed will remain the same, even if the consistency of the product changes.

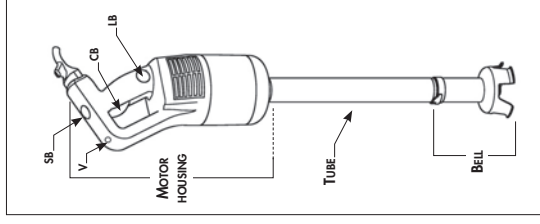

- **MASHED POTATOES FUNCTION**
(MP 350 Turbo Combi, MP 450 Turbo Combi, MP 450 Turbo FW).



A self-regulating speed system has been specially developed for pureeing tasks using the whisk.

A white circle marked on the speed variation switch indicates the speed dedicated to mashed potatoes preparation. To reach this speed, turn the knob counterclockwise until it stops and a slight detent is felt. Under load the Immersion Blender will stop and start at one seconds intervals.

- **POWER CORD**

After cleaning the machine, wind the cord around the specially designed lugs, without stretching it too much. This will prolong its lifespan.

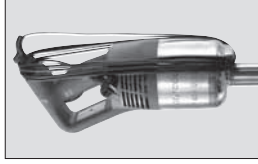

WORKING POSITION



WARNING

However the Immersion Blender is used, for safe operation, both hands must be positioned on the places described below and always kept as far as possible from sharp, rotating parts.

To make our machines more ergonomic, safer to use and easier to handle, we recommend using the "removable handle" attachment.

The handle can be used on all Immersions Blenders in the Large range including the Combi models (except the MP 800 Turbo).

We recommend holding the Immersion Blender by both the main handle and the removable handle. We also recommend tilting the Immersion Blender slightly, making sure that the bell does not come into contact with the bottom of the recipient.

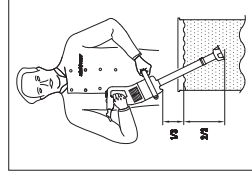

• BLADE FUNCTION

For your safety, it is forbidden to let the machine work alone during continuous operation of the machine. It is necessary to keep holding the handle with your hands in order to stop continuous operation quickly in case of emergency.

The use of any pan support is also forbidden.

- 1) For safe, efficient operation, the Immersion Blender must be held by the handle, as indicated in the drawing opposite.

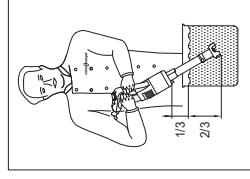

- the word "TOP" is facing upwards (1).
 - Turn the stainless steel adjusting screw anticlockwise (1) until the handle is slightly above the aluminium housing as indicated in step (2).
- N.B.** During assembly, check that the elastomer seal on the removable handle is always aligned with the rest of the handle (1).
- Then push the handle downwards until it sits on top of the aluminium housing (3).
 - Lock the handle into its final position by turning the adjusting screw clockwise (4) until fully tightened.

2) As shown in the drawing opposite, the Immersion Blender foot can also be placed in contact with the edge of the pan making sure it is held at an angle and that the bell is not in contact with the bottom of the pan.

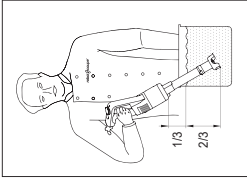

• **WHISK FUNCTION**

For greater efficiency, it is recommended holding the Immersion Blender by the handle and the motor base, as shown in the appended drawing.

The hand on the motor base supports the Immersion Blender.

You can also hold the appliance by the handle with one hand, leaving the other hand free to hold the bowl, if necessary.

MP 800 Turbo.

An handle which will help you to have a good grip and facilitate the moving of the machine.

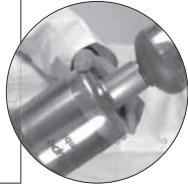
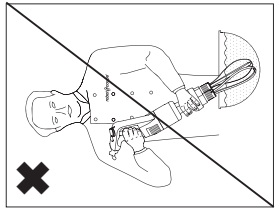
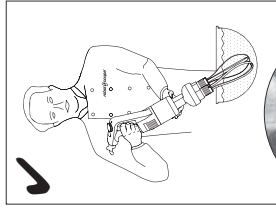
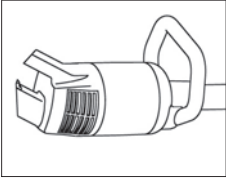

3) For optimum efficiency two thirds of the tube should be immersed in the product.

4) **Always make sure that the bell is completely immersed to avoid splashing and that the ventilation openings in the motor housing do not come into contact with any liquid !**

While processing we recommend that you move the whisk around in the bowl, in order to ensure that the mixture is completely homogeneous.

We strongly advise you to keep the whisk from touching the sides of the bowl.

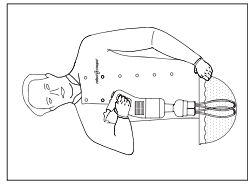

For maximum efficiency, at least one-fifth of the whisk length should be immersed. We also strongly advise you to start the processing at a low speed.

Handle conveniently located on the mixing tool for a better grip.

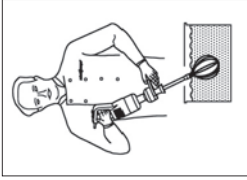

ASSEMBLY & DISASSEMBLY

• **BLADE FUNCTION**

Attaching the tube to the motor unit, (Except for MP 350 Turbo, MP 450 Turbo, MP 550 Turbo, MP 600 Turbo).

- Unplug the Immersion Blender.
- Unplug the machine then, align the flat side of **A** the conical part **C** of the tube with catch **B** in the aluminum casing.
- Insert the narrow portion of conical part **C** of the tube into the aluminum casing.
- Turn the tube in the direction of the arrow (see figure) until it is snugly in place.

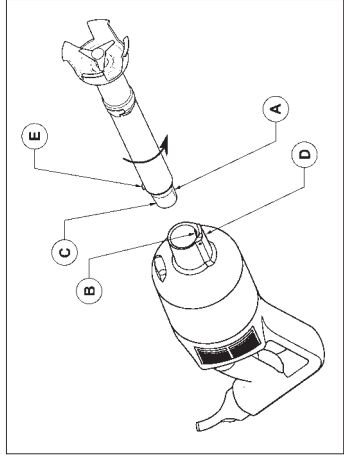

Removing the tube from the casing

- **Unplug the Immersion Blender.**
- Turn the tube in the opposite direction of that used to attach it.
- When it will not go any further, remove the tube from the conical part.

Attaching the bell to the tube

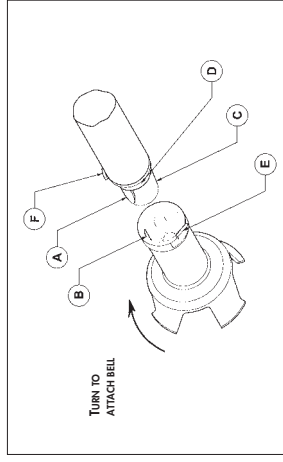

Unplug the Immersion Blender.

- Align the flat side of **A**, the conical part of the tube with catch **B** on the inside of the bell.
- Insert the conical part **C** into the bell. With the washer touching the tube seal **D**, turn the bell in the direction of the arrow (See figure) to lock the bell lug **E** and tube lug **F** snugly together.

Disassembling the bell from the tube

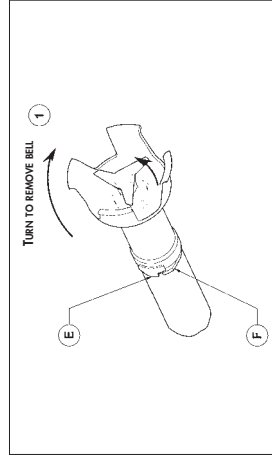

Unplug the Immersion Blender.

- Turn the bell in the direction of the arrow **1** (see next figure) to separate the bell lug **E** from the tube lug **F**.
- Remove the bell.

Removing the blades

Unplug the machine. Turn the bell in the direction of the arrow **1** (see next figure) to separate the bell **E** from the foot lug **F**.

Remove the bell.

To safely remove the sharp blades, hold with the provided blade locking tool. Using the blade disassembling tool, unscrew the male drive coupling. As the drive coupling is unscrewed disengage the blade for easy cleaning.

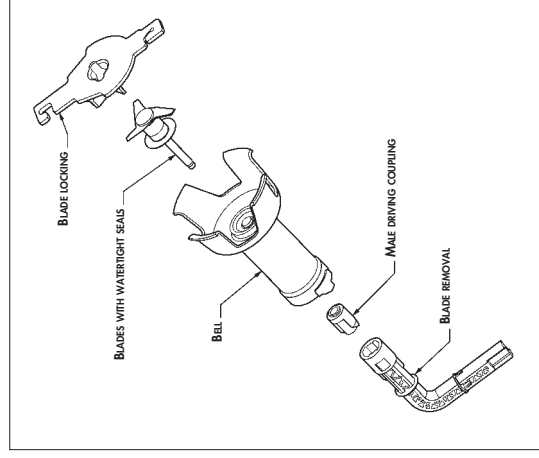

WHISK FUNCTION

- (MP 350 Turbo Combi, MP 450 Turbo Combi, MP 450 Turbo FW)

Attaching the whisk gearbox to the motor unit

- **Unplug the Immersion Blender.**
- Align the flat side **A** of the conical part **C** of the whisk gearbox with the catch **B** on the inside of the aluminum casing.
- Insert the conical part **C** of the whisk gearbox into the aluminum casing.
- Turn the whisk gearbox in the direction of the arrow (see figure) until it is snugly locked into place.

Removing the gearbox

- **Unplug the Immersion Blender.**
- Turn the whisk gearbox in the opposite direction from that used to attach it.
- When it will go no further, remove the whisk gearbox from the aluminum casing.

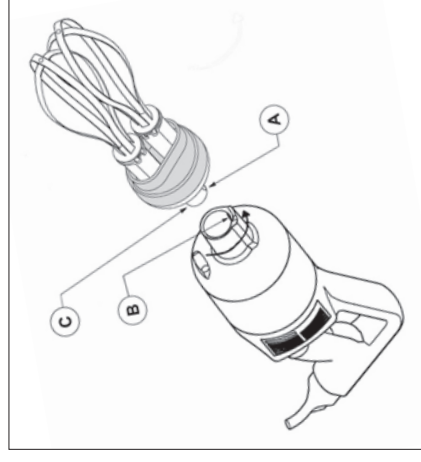

Fitting the whisk into the whisk gearbox

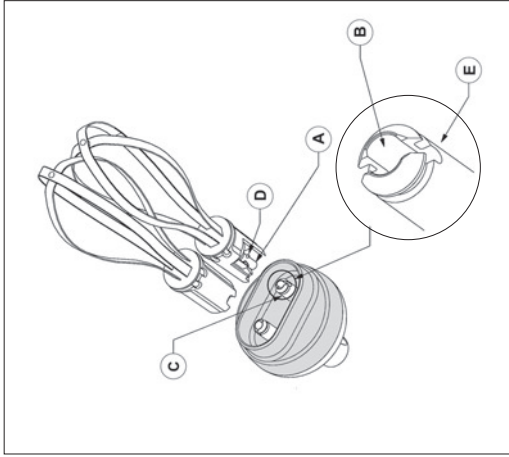

- Grasp the holder in one hand.
- With the other hand, take the first whisk and insert the shaft **A** into the bore **B** of the whisk gearbox drive shaft. Make sure the drive lugs **D** are properly aligned with the notches.
- As you push the whisk into the holder drive shaft **C**, rotate it slightly in order to slide the drive lugs into the notches **D** of the drive shaft **C**, thereby locking the whisk into place inside the shaft.
- To check that the whisk is properly fixed inside the shaft **C**, gently pull the metal wires.
- Repeat this procedure with the second whisk. If you cannot push it in properly, remove it, rotate it 90° and start again.

Removing the whisk from the whisk gearbox

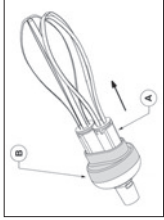

While gripping the ejector **A** in one hand and the holder **B** in the other, pull the ejector in the direction of the arrow.

Removing the ejector

Hold the whisk by the wires **B** in one hand. With the other hand, pull the ejector **A** in the direction of the arrow (see figure).

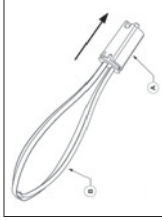

MIXING TOOL FUNCTION (MP 450 Turbo FW XL)

Attaching the mixing tool to the mixing tool housing:

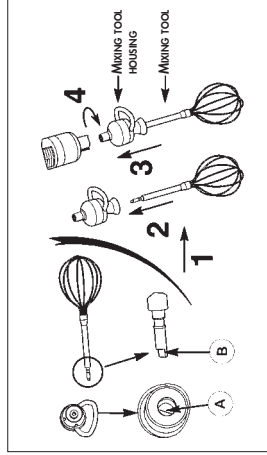

Line the flat side of the mixing tool **B** up with the flat side of the housing **A**.

Once the mixing tool has been attached to the housing, simply insert the latter into the motor unit, turning it in an anticlockwise direction.

Detaching the mixing tool from its housing:

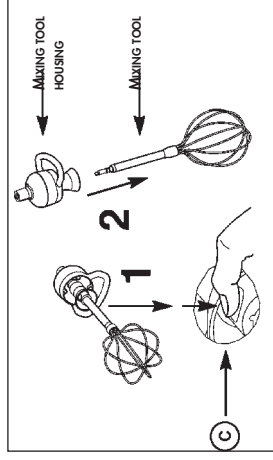

To release the mixing tool from its housing, simply press the button **C**. All that then remains to be done is to remove the housing from the motor unit.

CLEANING

WARNING

- Always unplug the Immersion Blender before cleaning it!
- Always dilute bleach according to the instructions on the label
- Never run the motor assembly through a dish machine.
- The type and concentration of the sanitation agent must comply with 21 CFR 178.1010 regulations.
- Clean according to local health department regulations.

• MOTOR HOUSING

The Immersion Blender must be clean through all stages of production. Clean between each job using a detergent or disinfectant. Dilute the detergent/disinfectant following the instructions normally specified on it's packaging container. Use a cloth **lightly dampened (not dripping)** with the cleaning solution.

Do not allow liquid to come into contact with the electrical components contained within the housing. Be careful when cleaning around vents do not allow liquid to drip or seep into the housing. Use a cloth lightly dampened (not dripping) with water to remove detergent/disinfectant then dry using a clean cloth.

After using the Immersion Blender in a hot mixture, cool the bottom of the tube in cold water before disassembling the bell from the tube.

Clean immediately after use to prevent product from sticking to surfaces.



WARNING

Never immerse motor housing and/or handle in liquid! The housing contains the electrical components and is not sealed against liquid. Contact with liquid can cause damage to the Immersion Blender and serious injury to the operator.

• TUBE AND BELL

There are two ways to proceed:

- **Simple cleaning procedure after each different use**
- Submerge the tube and bell in water and run for a few seconds to clean.

- Unplug the power cord.

Complete cleaning procedure on a daily basis

- Unplug the Immersion Blender and rinse the bell under a water tap.
- Remove the bell from the tube, then remove the blade (**wear cutting gloves**) ! Be careful to avoid damaging the surface of the blade shaft and the watertight seals.
- Always dilute the detergent/disinfectant (see above).
- Thoroughly dry all parts before reassembling.

• BLADE

The blade can be removed from the bell for thorough cleaning.

After cleaning, dry all the parts carefully to prevent oxidation.

• ALUMINUM

Use soft-metal-safe cleaning agents!

• PLASTIC

Be careful, many cleaning agents are corrosive and are not safe for use on plastics!

Do not use strong alkaline detergent (having a high concentration of soda or ammonia).

• WHISK GEARBOX

Never immerse the whisk gearbox in water. Clean it with a cloth lightly dampened (not dripping).

Never run the whisk gearbox through a dishwasher.

• WHISKS

The whisks can be cleaned either by hand or in a dishwasher.

To ensure effective cleaning, always remove the whisk ejector.

• MIXING TOOL HOUSING

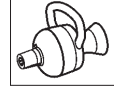

Never immerse the mixing tool housing in water or put it in the dishwasher. Instead, clean it with a slightly damp cloth.

• MIXING TOOL



The mixing tool can be washed either by hand or in the dishwasher. You can also clean it with a slightly damp cloth.

MAINTENANCE

• BLADE

The performance of the cut essentially depends on the state of your blades and their wear. The blades are subject to wear and as such need to be replaced from time to time to ensure the consistent quality of the end product.

You are also advised to change, at the same time, the washer and the watertight seals.

A blade service kit is available.

• WHISKS

The performance of the whisks depends on the condition of the wires. The metal wires may become worn over time. In order to ensure optimum performance, they will need to be replaced. **Do not use a defective or damaged whisk!**

• POWER CORD:

For your safety, make sure the power cord is always in good condition. The cord is subjected to considerable wear and tear, and must be replaced if it is damaged in any way (cuts, burns, etc.).

Procedure for replacing the power cord:

- 1) Use the dismantling tool supplied with the new replacement cord.
- 2) Press the push button (see photo) and pull on the cord without releasing the dismantling tool.

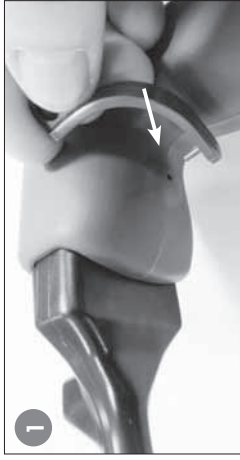

- 3) Installing the new cord:

Connect the "Easy-Plug" to the motor housing.

Before doing so, make sure the electrical plug is not connected to the power supply.

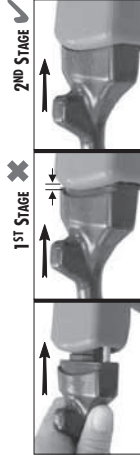

Connect the electrical plug to the power supply.

Make sure the plug is pushed in far enough (two stages).
If it is not, the control buttons will not work.

• TUBE SEAL

In order to maintain a watertight seal between the tube and bell, inspect the seal for wear and replace it if necessary.

• SEAL RING

The seal ring can be lubricated using a suitable food grade grease.

In order to maintain a watertight seal, check the seal ring for wear and replace it if necessary.

The seal ring is easy to replace so we strongly recommend always checking it is in good repair.

• CARTRIDGE

You need to change the cartridge:

- If liquid starts seeping into the foot,
- If there is any play in the blade.

1) Cartridge dismantling:

Position the knife dismantling tool **C** on the cartridge **B**. Remove the cartridge from its place by knocking **D** on the knife dismantling tool **C** with a plastic mallet.

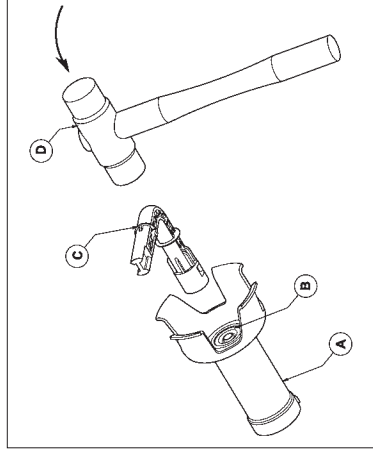

2) Cartridge mounting:

Direct the ears of cartridge **B** in order to be aligned with the groove of the bell **A**.

Push the cartridge with the hand in the direction of arrow, then clip on into the bell thanks to the knife dismantling tool.

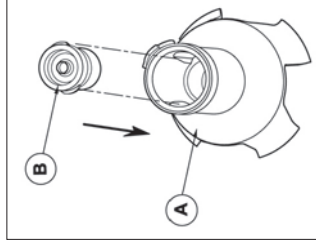

TROUBLE SHOOTING

• THE IMMERSION BLENDER DOES NOT START.

1. Did you follow the previous operating instructions? See section "OPERATING THE IMMERSION BLENDER" page 6.

2. If the green "ON" indicator does not light up when the control button (CB) is pressed, check the following:
 - The network voltage
 - Correct connection of the cable to the wall plug.
 - Correct attachment of the cord to the handle (see page 12).
 - The state of repair of the cord (any cut wires) If this is the case, see replacement procedure on page 12.

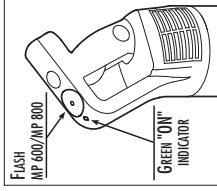

3. Is the machine too hot ? (the Immersion Blender is not operating but the green "ON" indicator up when the control button (CB) is pressed). Allow the Immersion Blender to cool. Then retry.
4. Pull the plug and try another outlet.
5. Check the GFI trip indicator on your outlet. Check the circuit breaker.
6. Call local Robot Coupe authorized service agency.

- **THE IMMERSION BLENDER STOPS DURING (WHILE) PROCESSING.**

See the section "OPERATING THE IMMERSION BLENDER" page 6.

- The first paragraph describes the overload protection. It may be necessary to allow the machine to cool for up to 30 minutes before restarting.

if the reason is unknown or if the green "ON" indicator comes on when the control button is pressed but the motor does not start:

- Release the control button (CB).
- Unplug the Immersion Blender.

- Are the blades free to rotate in the bell?
- Is the drive shaft free to rotate? To check this, unplug the Immersion Blender, remove the bell and test the rotation of the end of the drive shaft manually.

Check the condition of the plug and the power cord.

- **THE IMMERSION BLENDER STARTS TO SMELL HOT OR SMOKE**

- Turn the Immersion Blender off and unplug it.
- Call your local authorized service agency.

- **THE MACHINE TRIPS THE GFI (Ground fault Interrupt) OUTLET**

The motor or controls are wet or damaged. Do not attempt to use the Immersion Blender until it has been repaired by qualified service persons.

- **OVERLOAD WARNING LIGHT (MP 600 Turbo and MP 800 Turbo)**

In case of overload or use of the Immersion Blender in a too sticky preparation, the intensity warning flashes for 5 seconds to inform you that the motor will stop shortly.

This stop indicates that the preparation in process is too thick or can not be made with a Immersion Blender.

In this case, you can still restart your Immersion Blender. However, your machine will stop again if the consistency of the preparation is not modified.

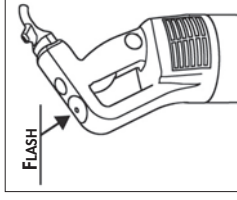

WARNING

THE BLADES ARE SHARP! It is recommended that cutting gloves be worn when handling the blades. Handle and store the blades with safety in mind.

Never try to override or defeat the purpose of the safety mechanisms!

Never put anything (utensils etc.) but food material near the blades on the Immersion Blender!

Never overload the Immersion Blender!

Never turn the Immersion Blender on, unless the bell is completely immersed in the product.

Always unplug the Immersion Blender before doing any cleaning or maintenance!

Unplug the Immersion Blender whenever it is not being used.

Plug the Immersion Blender only into a GFI type outlet.

Never use extension cords.

SERVICE

See warranty first then;

Should your unit require service, check with your distributor to see where local service is available.

If not or if you wish your unit to be serviced at the factory, call for return instructions and ship the unit prepaid to our factory address.

Robot Coupe U.S.A., Inc.,
Service Department
264 South Perkins
Ridgeland, MS 39157
Phone : 800/824-1646

For service in Canada contact the Robot-Coupe USA factory for repair instructions.

robot  coupe[®]

**ELECTRICAL AND
WIRING DIAGRAMS**

MP350 SeriesC - MP450 SeriesC - MP550 SeriesC - MP600 SeriesC - MP800 SeriesC
120V/60Hz - 1~

ESQUEMA CONEXIONES

SCHEMA ELECTRIQUE

ELECTRIC DIAGRAM

| English | Français | Español |
|---------|-------------------|---------------------------|
| A | Aluminium housing | Carter aluminio |
| C | Control unit | Unidad de control |
| M | Motor | Motor |
| R | Rectified bridge | Pont de diodes |
| SW1 | On/off switch | Interrupteur marche/arrêt |
| SW2 | On/off switch | Interrupteur marche/arrêt |
| V | Indicator light | Luz de indicación |
| Ø | Thermal protector | Protecteur thermique |

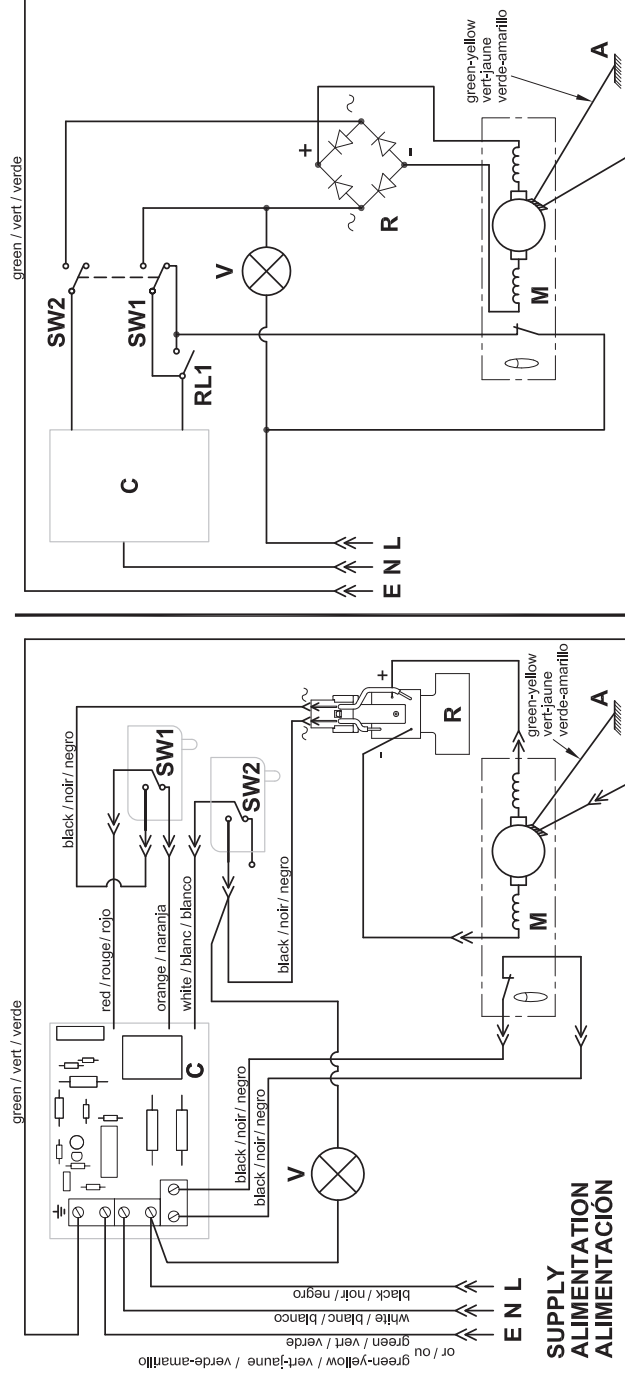

robot@coupe®

N° 402678 (d)

Maj : 12/21

MP350 V.V. SeriesC - MP350 Combi SeriesC - MP450 V.V. SeriesC - MP450 Combi SeriesC - MP450 F.W. SeriesC - MP450 FW XL SeriesC
 120V/60Hz - 1~
 SCHEMA ELECTRIQUE

ESQUEMA CONEXIONES

ELECTRIC DIAGRAM

| English | Français | Español |
|---------|-------------------|---------------------------|
| A | Aluminium housing | Càter aluminium |
| C | Control unit | Unidad de control |
| JB | Junction board | Circuito de conector |
| M | Motor | Motor |
| P | Potentiometer | Potenciometro |
| R | Rectified bridge | Rectificador diodo |
| SW1 | On/off switch | Interruptor marcha/parada |
| T | Triac | Triac |
| VS | Velocity sensor | Capteur de vitesse |
| V | Indicator light | Luz de indicación |
| θ | Thermal protector | Protector térmico |

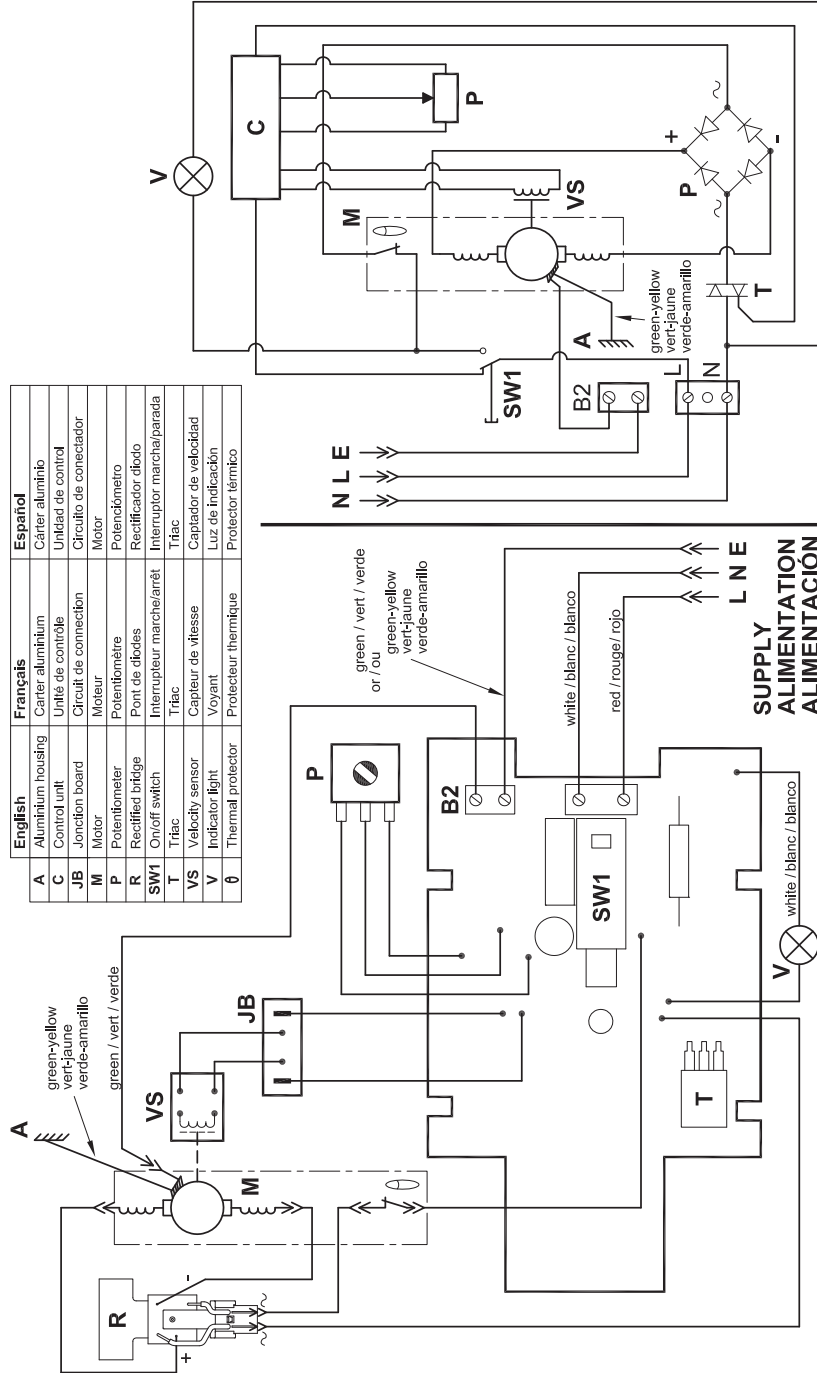

robot@coupe®

N° 402679 (d)

Maj : 12/21



robot coupe[®]

Robot Coupe U.S.A., Inc.,

Phone: 800/824-1646 • 601/898-8411

264 South Perkins St., Ridgeland, MS 39157

e-mail: info@robotcoupeusa.com

website: www.robot-coupe.com



37002314450716

Ref: 450 721c - 03/11/2022 - USA