

robot coupe®

NEW
Register
your product
on line



CL 55 E

Robot Coupe U.S.A., Inc.

264 South Perkins St., Ridgeland, MS 39157

Phone : 800/824-1646 • 601/898-8411

e-mail: info@robotcoupeusa.com • website: www.robot-coupe.com



www.robotcoupeusa.com

robot coupe CALL US NOW! 1-800-824-1646

English - USA | Español-USA | Français - QUEBEC | More...
Parts Diagrams

CATALOG ▾ SELECTION GUIDE PRODUCT INFO VIDEOS OUR RECIPES CONTACT US SALES REF **SUPPORT** Search

Access to Part Diagrams **Register your product**

Service Agencies

robot coupe HOME CATALOG SELECTION GUIDE PRODUCT INFO VIDEOS OUR RECIPES SUPPORT SITEMAP
Log on Other languages

© All rights reserved, 2010.

Register your product online

We reserve the right to alter at any time without notice the technical specifications of this appliance.
None of the information contained in this document is of a contractual nature. Modifications may be made at any time.
© All rights reserved for all countries by: **ROBOT-COUBE S.N.C.**

IMPORTANT WARNING



WARNING: In order to limit accidents such as electric shocks or personal injury, and in order to limit material damage due to misuse of the appliance, please read these instructions carefully and follow them strictly. Reading the operating instructions will help you get to know your appliance and enable you to use the equipment correctly. Please read these instructions in their entirety and make sure that anyone else who may use the appliance also reads them beforehand. Our equipment is designed for professional use and must not be used by children under any circumstances.

UNPACKING

- Carefully remove the equipment from the packaging and take out all the boxes or packets containing attachments or specific items.
- **WARNING** - some of the tools are very sharp e.g. blades, discs... etc..
- Store manuals, tools and spare parts in a safe place available to the users of the machine

INSTALLATION

• This machine must be operated on a clean sturdy counter or table. Keep the area around and under the machine clear to allow air circulation. Otherwise the motor can overheat. All four feet must be in place.

CONNECTION

- Always check that your power supply corresponds to that indicated on the identification plate on the motor unit and that it can withstand the amperage.
- The unit must always be connected to a grounded outlet with Ground Fault Circuit Interrupter (GFCI) protection device.
- Always check that the motor shaft rotates in counter clockwise direction before the blades are installed.

HANDLING

- Always take care when handling the blades, as they are extremely sharp.
- Wear cut-proof gloves when handling the blades.

USE

- The machine must not be modified in any way from its original configuration.
- Never tamper with, or defeat the purpose of the locking and safety systems.
- Do not put nonfood objects in the bowl.
- Do not leave the machine running unattended.
- The machine must be operated and stored in a location not subject to water drips or spray or explosive vapors.
- Should the machine malfunction or should any part be damaged, it must not be operated until it is repaired by a qualified technician using only genuine Robot Coupe repair parts.
- Failure to follow these operating instructions or attempts to operate the machine outside its design limits may create a hazardous condition that could damage the machine and/or injure users. Special attention should be given to the use of the operation controls and safety features.
- The unit is equipped with a thermal overload circuit-breaker. If the unit overheats due to an overload condition, it will automatically shut off. After cooling a few minutes the thermal overload circuit-breaker may be reset. Press the reset button located on the bottom left front of the unit.
- Operating times of 5 minutes or longer can cause processed food to increase to temperatures above 125° F (52° C).
- Maximum fill level is $\frac{2}{3}$ full, less if the product is very dense or sticky.

CLEANING

- As a precaution, always unplug your appliance before cleaning it.
- Always clean the appliance and its attachments at the end of each cycle.
- Never immerse the motor base in water.
- For parts made from aluminum, use metal safe detergents intended for aluminum.
- Caustic detergents used in automatic dishwashers quickly degrade plastic parts. Hand wash plastic parts if possible.
- Robot Coupe can in no way be held responsible for the user's failure to follow the basic rules of cleaning and hygiene.

MAINTENANCE

- Do not open the motor housing. There are no user serviceable components inside the electrical housing. Refer control component repairs to qualified technicians.
- Replace seals every 3 to 6 months. Lubricate with food safe grease.
- It is particularly important to maintain and check the attachments since certain ingredients contain corrosive agents, e.g. citric acid.
- Never operate the appliance if the power cord or plug has been damaged or if the appliance fails to work properly or has been damaged in any way.
- If the machine malfunctions in any way discard any food being processed and refer service to qualified maintenance technicians.

CONTENTS

—	WARRANTY	—	CHOOSING THE RIGHT DISC
—	IMPORTANT WARNING	—	CLEANING
■	INTRODUCTION TO YOUR NEW VEGETABLE PREPARATION MACHINE CL 55 "E" Version	—	MAINTENANCE <ul style="list-style-type: none">• Motor seal• Blades and plates• Grating discs
—	SWITCHING ON THE MACHINE		
■	FUNCTIONS OF HOPPERS AND THEIR TOOLS <ul style="list-style-type: none">• Pusher feed-head• Tubes feed head• Automatic feed head	—	TECHNICAL SPECIFICATIONS <ul style="list-style-type: none">• Weight• Working height• Noise level
—	INSTALLING THE DISCS AND TOOLS	—	SAFETY
—	INSTALLING THE HOPPERS <ul style="list-style-type: none">• Pusher feed-head• Tubes feed head• Automatic feed head	—	SERVICE
—	CHANGING THE DISCS	—	TECHNICAL DATA <ul style="list-style-type: none">• Electrical and wiring diagrams

ROBOT COUPE U.S.A., INC. ONE YEAR LIMITED COMMERCIAL WARRANTY

YOUR NEW ROBOT COUPE COMMERCIAL PRODUCT IS WARRANTED TO THE ORIGINAL PURCHASER FOR A PERIOD OF ONE YEAR FROM THE DATE OF PURCHASE.

This LIMITED COMMERCIAL WARRANTY is against defects in the material and / or workmanship, and includes labor for replacement of defective parts, provided repairs are performed by an authorized service agency (see attached list). The CUSTOMER must inform the Service Agency of the possibility of warranty coverage and provide a copy of the dated sales or delivery receipt BEFORE WARRANTY REPAIRS ARE BEGUN. All parts or accessories replaced under warranty must be returned to the Service Agency. The warranty for work done or parts replaced under warranty expires at the end of the original warranty period.

Replacement parts and accessories are warranted for ninety (90) days from the date of purchase when purchased separately and will be verified by dated sales receipt OR packing slip which list that item.

All Robot Coupe Products are considered commercial use only.

THE FOLLOWING ARE NOT COVERED UNDER WARRANTY:

- 1 - Damage caused by abuse, misuse, dropping, or other similar incidental damage caused by or as result of failure to follow installation, assembly, operating, cleaning, user maintenance or storage instructions, including failure to verify and correct rotation of three phase motors.
- 2 - Labor to sharpen and/or parts to replace knife assemblies or blades which have become dull, chipped, or worn due to normal use.
- 3 - Material or labor to renew or repair scratched, stained, chipped, dented, or discolored surfaces, blades, knives, attachments, or accessories.
- 4 - Transportation charges to or from an authorized service agency for repairs of a machine designated as "CARRY IN SERVICE" (Table Top Models).
- 5 - Labor charges to install or test attachments or accessories (i.e. bowls, cutting plates, blades, attachments) which are replaced for any reason.
- 6 - Charges to change Direction-of-Rotation of Three Phase electric motors (INSTALLER IS RESPONSIBLE). All Robot Coupe products must operate counter-clock-wise.
- 7 - SHIPPING DAMAGE IS NOT COVERED BY WARRANTY. Visible and hidden damages are the responsibility of the freight carrier. The consignee must file a damage claim promptly against the carrier, or upon discovery in the case of hidden damage.
- 8 - Any ROBOT COUPE COMMERCIAL PRODUCT used in an Industrial application.

Commercial equipment use is defined as but not limited to the preparation of food substance within the confines of a restaurant/facility, that is sold and consumed within said restaurant/facility.

Industrial equipment use is defined as but not limited to the manufacturing of food substance in large batch quantities. The processed food is then packaged and sold off site and or to a distributor for resale off site.

KEEP ALL ORIGINAL CONTAINERS AND PACKING MATERIALS FOR CARRIER INSPECTION

All Robot Coupe equipment should be operated in an ambient room temperature of 60 degrees (F) or higher.

Robot Coupe U.S.A., Inc., Robot Coupe S.A., or any of their affiliates, distributors, officers, directors, agents, employees or insurers will not be obligated for consequential or other damages, losses, or expenses in connection with or by reason of the use of or the inability to use the machine for any purpose.

THIS WARRANTY IS GIVEN EXPRESSLY AND IN LIEU OF ALL OTHER WARRANTIES EXPRESSED OR IMPLIED, FOR MERCHANTABILITY AND FOR FITNESS TOWARD A PARTICULAR PURPOSE AND CONSTITUTES THE ONLY WARRANTY MADE BY ROBOT COUPE, U.S.A., Inc.

IMPORTANT WARNING



WARNING: In order to limit accidents such as electric shocks or personal injury, and in order to limit material damage due to misuse of the appliance, please read these instructions carefully and follow them strictly. Reading the operating instructions will help you get to know your appliance and enable you to use the equipment correctly. Please read these instructions in their entirety and make sure that anyone else who may use the appliance also reads them beforehand. Our equipment is designed for professional use and must not be used by children under any circumstances.

UNPACKING

- Carefully remove the equipment from the packaging and take out all the boxes or packets containing attachments or specific items.
- **WARNING**-some of the parts are very sharp e. g. blades, discs... etc.

INSTALLATION

- Install your machine on a clean and level floor with adequate room to safely operate the machine.

CONNECTION

- The CL 55 "E" must be attached to standard 120 Volt 60 Hz grounded outlet NEMA 5-15. Robot Coupe recommends ground fault type outlet be used.

HANDLING

- Always take care when handling the blades, as they are extremely sharp.

DIMENSIONS (in inches)

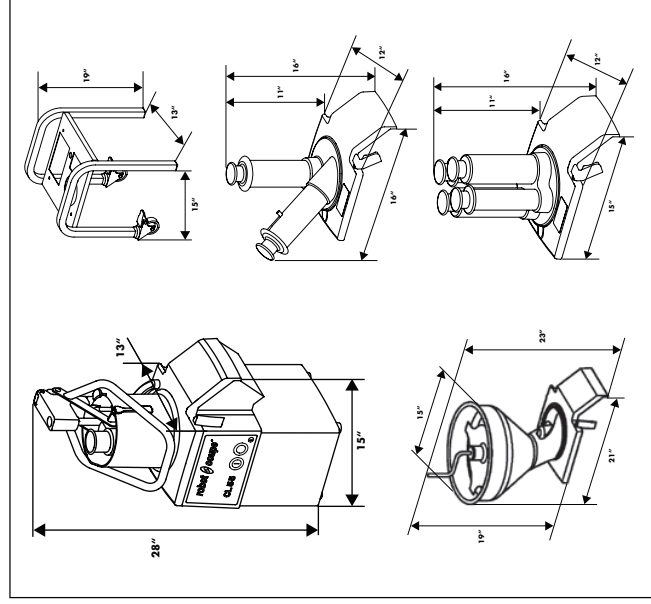

CLEANING

- As a precaution, always unplug your appliance before cleaning it.
- Always clean the appliance and its attachments regularly each 50 to 100 pounds of processing and at the end of each cycle..
- Never immerse the motor unit in water.
- For parts made from aluminum, use cleaning detergents intended for aluminum.
- For plastic parts, do not use detergents that are too alkaline (e.g., containing too much caustic soda or ammonia).
- Robot Coupe can in no way be held responsible for the user's failure to follow the basic rules of cleaning and hygiene.

MAINTENANCE

- Before opening the motor housing, it is absolutely vital to unplug the appliance.
- Check the seals and washers regularly and ensure that the safety devices are in good working order.
- It is particularly important to maintain and check the attachments since most vegetables contain corrosive agents, e.g. citric acid.
- Never operate the appliance if the power cord or plug has been damaged or if the appliance fails to work properly or has been damaged in any way.
- Do not hesitate to contact your local Maintenance Service if something appears to be wrong.

USE

- Never try to override the locking and safety systems.
- Never insert any object into the container where the food is being processed.
- Never push the ingredients down with your hand.
- Do not overload the appliance.
- Never switch the appliance on when it is empty.

INTRODUCTION TO YOUR NEW VEGETABLE PREPARATION MACHINE CL 55 "E" Version

The CL 55 is perfectly geared to professional needs. It can perform any number of tasks, which you will gradually discover as you use it.

For CL 55 a wide range of disk and grids are available to satisfy even the most demanding chefs when it comes to cutting up fruit and vegetables, i.e. slicing, grating, julienne, dicing and french fried potatoes discs.

Its numerous functions will open the door to a whole new culinary world.

Thanks to its simple design, all components requiring frequent handling for maintenance or cleaning can be fitted and removed easily.

To make things easier for you, this manual gives a breakdown of all the various fitting operations.

This manual contains important information designed to help the user get the most out of the CL 55 vegetable preparation machine.

We therefore recommend that you read it carefully before using your machine.

We have also included a few examples to help you get the feel of your new machine and appreciate its numerous advantages.

SWITCHING ON THE MACHINE

Before plugging in, check that your power supply corresponds to that indicated on the machine's identification plate.



This appliance must be plugged into an earthed socket (risk of electrocution).

The machine comes with a power supply cord having an integrally molded plug.

The CL 55 should be connected to a grounded: 120 V/ 60 Hz /1 Phase power outlet.

Robot-Coupe recommends a ground fault type outlet be used.

FUNCTIONS OF HOPPERS AND THEIR TOOLS

• PUSHER FEED-HEAD

This hopper allows you to prepare all types of vegetables:

- the large feed hopper is used to prepare bulky vegetables such as cabbage, celery, lettuce, etc.,

- the tube is used to prepare long or fragile fruit or vegetables.

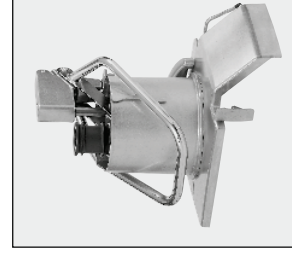

Two types of tool are designed for the lever-type hopper:

1) **The loading cone**, which guides the vegetables (except for cabbage) towards the blades. This tool must be screwed firmly onto the motor shaft.

Loading cone should not be used when processing large firm vegetables such as large potatoes or onions. Use the Cabbage cutter below.

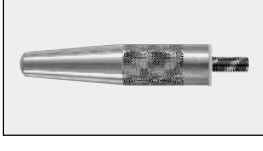

2) **Cabbage cutter** used to prepare cabbage and lettuce and to prepare large sized vegetables such as potatoes and onions or other oversized vegetables.

Wrench Use this tool to safely remove the cabbage cutter.



• TUBES FEED HEADS

4 TUBES FEED-HEAD

This feed-head is equipped with 4 straight tubes: 2 straight tubes of 50 mm diameter and 2 straight tubes of 70 mm diameter.

This hopper is designed for the preparation of long vegetables like carrots, cucumbers, leeks, etc., or of fragile fruit and vegetables such as tomatoes, bananas, etc.

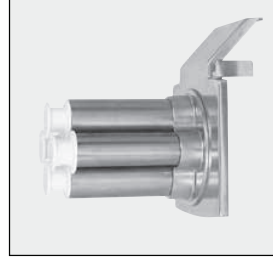

STRAIGHT AND SLOPING TUBES HOPPER

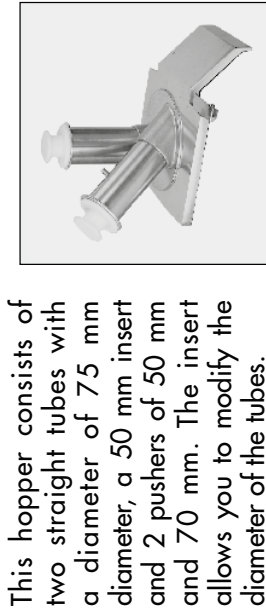

This hopper consists of two straight tubes with a diameter of 75 mm diameter, a 50 mm insert and 2 pushers of 50 mm and 70 mm. The insert allows you to modify the diameter of the tubes.

This hopper performs the same functions as the one described above with its straight tube. But it is different in that it is equipped with a sloping tube especially designed for slanted cutting.

No special tool is required to attach these hoppers onto the disc.

• AUTOMATIC FEED-HEAD

This hopper is intended for continuous cutting tasks.

It is ideal for slicing delicate vegetables such as mushrooms and tomatoes, grating carrots, slicing potatoes and cutting french fries, to mention but a few of its uses.



This hopper is not suitable for certain specific tasks, such as :

- slicing long vegetables (use the small opening in the whole feed head).
- preparing bulky vegetables which are too big to be fed into this hopper (use the pusher feed-head).

Make sure that the agitator is in place, in order to avoid blockages and variations in cutting quality. It is vital that this tool be fitted each time the automatic hopper is used.

Two types of tool are designed for the lever-type hopper:

1) **The agitator**, which guides the vegetables (except for cabbage) towards the blades.

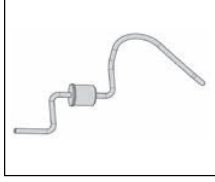
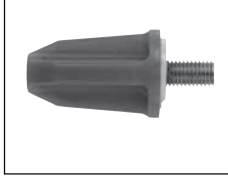

2) Introducing the vegetables too quickly can result in a logjam. If this occurs, clear the blockage using **the crank** supplied for that purpose.

Other tools, wands, spoons can damage the machine so must not be used.

The crank serves to clear the machine if it becomes clogged up with bulky vegetables.



INSTALLING THE DISCS AND TOOLS

Two ejection tools:

The CL 55 is supplied with two ejection tools. **The white ejector has been specially designed to cope with cabbage.** For all other vegetables, use the black plastic ejector disc.



1 With the motor unit facing you, slot the black discharge disk or white ejection tool onto the motor shaft and check that it is properly positioned at the bottom of the bowl.

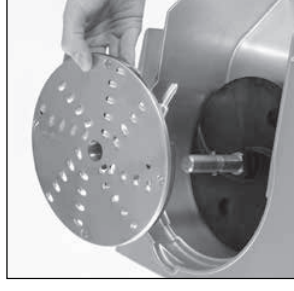
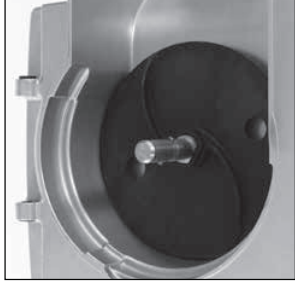

2 **Position your chosen disc:**

a) **If you have opted for a slicing, grating or julienne disc:** position the disc on the motor shaft. To ensure that it is correctly positioned, turn it in a clockwise direction.

b) **You have chosen a dicing unit:**

i.e. a grid and a special slicing disc for diced vegetables.

Slicing discs and dicing grids can be mounted in the following combinations:

Dicing grid / Slicer	5x5 mm	8x8 mm	10x10 mm	14x14 mm	20x20 mm	25x25 mm
5 mm	●					
8 mm		●				
10 mm			●			
14 mm				●		
20 mm					●	
25 mm						●

You will find all the combinations marked ● on our machines and accessories price list. The dimensions of the dicing grid should always be equal to or greater than those of the slicing disc.

Place the dicing grid in the bowl of the vegetable processor.

Make sure that the spur on the grid is fully engaged in the locking slot of the motor unit.

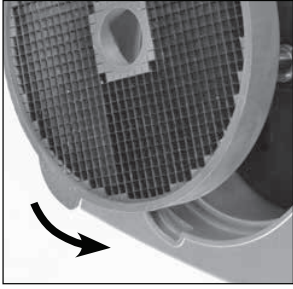

Position the French fries grid in the vegetable preparation bowl.

Check that it is correctly positioned with the French fries plate positioned at the outlet.



No tools (loading cone or cabbage cutter) are required when using the divider.

Next, fit the corresponding slicing disc (straight-edged blade) and rotate in a clockwise direction to ensure that it is correctly positioned.

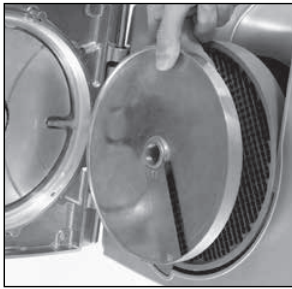

Next fit the appropriate slicing disc and rotate in a clockwise direction to check that it is correctly positioned.

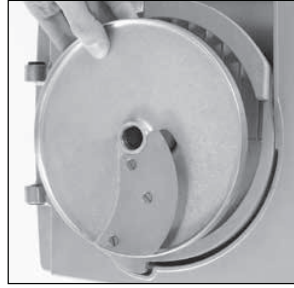

c) If you want to use the French fries potatoes cutting equipment:

This equipment comprises a French fries grid and a special French fries slicing disc.

⚠ WARNING PUSHER FEED HEAD

To get the very best results when cutting french fries, remember to insert the **removable divider** in the hopper and load the potatoes into the left-hand compartment (see photo opposite).

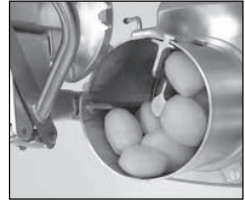

Screw the tool (unless you are using the removable partition) firmly onto the motor shaft.

INSTALLING THE HOPPERS

• PUSHER FEED-HEAD

USING THE FEED TUBE

Fill the feeder right up to the top with vegetables. Apply a downwards pressure on the pusher and maintain it until all the vegetables have been processed.

Always press the vegetables down with a pusher to improve cutting efficiency.

HOW TO USE THE CYLINDRICAL HOPPER



WARNING



To get the very best results when cutting french fries, remember to insert the **removable divider** in the hopper and load the potatoes into the left-hand compartment (see photo opposite).

1 Position the veg prep hopper on the motor unit. The locking handle should be facing you, on the right.



Ⓢ The choice of disc-fixing tool will vary according to the hopper and the type of vegetable:

Hopper	Vegetable	Tool
Pusher	All types except for cabbage and french fries	Loading cone
Pusher	Cabbage	Cabbage cutter + key
Pusher	French fries	Removable partition
Automatic	All	Agitator
4-tubes	All	No tool



② **Slide the hinge pin** into the hinge rings provided at the back of the motor base. Next, lock the lid onto the motor unit using the locking handle.



② Slip the hinge pin into the locations provided at the back of the motor base. The locking handle should now be facing you, on the right.

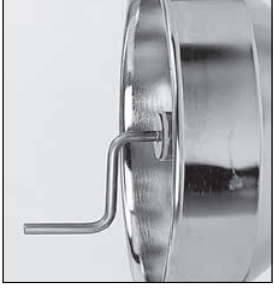

③ Insert the pusher head into the feed tube and turn it until the plastic part is correctly wedged inside the tube.

- Fill the feeder right up to the top with vegetables.
- Lower the pusher so that it is flush with the top of the feed opening.
- Press the pusher down to guide the food through the machine. The exact amount of pressure required will depend on the nature of the cut, bearing in mind that too much force reduces cutting quality without increasing throughput.
- Cut cabbages in half and remove the core before processing, in order to avoid unnecessary strain and ensure an end-product of a higher quality.
- Lift the pusher and allow access to the feed tube.

• TUBES FEED HEADS

① Position the 4-tubes hopper, or the straight and inclined tube hopper, on the motor unit. The locking handle should now be facing you, on the right.

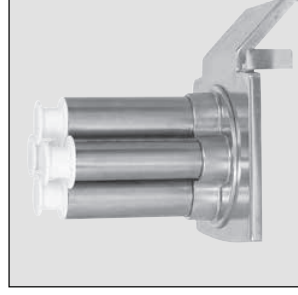

• AUTOMATIC FEED-HEAD

① et ② Proceed as specified for the pusher-feed head.

③ Screw the agitator onto the motor shaft.



④ Position the automatic hopper on the motor base. The fastening hook is now facing you on your right.



⑤ Slide the hinge pin into the slots provided at the back of the motor base. Then, lock the lid onto the motor base using the fastening hook.

CHANGING THE DISCS



The machine should be switched off (by pressing the red push-button) before starting to change the disc.

① With the motor unit facing you, use your right hand to release the aluminium fastening hook used to lock the hopper onto the motor base.

② a) **Feed opening fitted with a lever:**

Lift the pusher and release the bowl by tilting it to the left so that the hopper can be tilted backwards. Then inscrew the loading cone or the hollowing cutter. For the hollowing cutter, use the dismantling tool provided for that purpose.

b) **With hole feed-head:**

First remove the inserts and the pushers and then lift the fastening hook in order to tilt the hopper backwards to release the bowl.

c) **Automatic feeder:**

Lift the fastening hook in order to tilt the hopper backwards to release the bowl.



WARNING

**Use caution handling disk.
Always use cutting gloves. Knives are sharp.**

- ③ Free the disc by lifting it by its edges.
For dicing equipment, you are advised to pull out the grid and disc assembly together. Then remove the discharge disc using the two holes. If the disc is stuck, turn it slightly in the anticlockwise direction.

- ④ When fitting dicing equipment, it is advisable to clean the inside of the bowl thoroughly with a damp cloth or sponge, especially the part onto which the grid is to be fitted.

We recommend that you remove the grid and disc together. To make the job easier, turn the ejector disc.

Always use a properly cleaned grid. Never process soft foodstuffs after hard ones without properly cleaning the grid beforehand.

Use our **D-Clean Kit** (ref. 39881) to clean your 5x5, 8x8 and 10x10 dicing grids quickly and easily.

- ⑤ Then fit the discharge disc, the slicing, grating or julienne disc, or the dicing equipment as described in steps 1) and 2) in the previous section on the relevant hopper.

- ⑥ Close then latch the lid using the fastening hook.

CHOOSING THE RIGHT DISC

SLICERS		RIPPLE CUT SUCER		GRATER		JULIENNE	
S06	amands	R2	beet root / potato / carrot / zucchini	G1,5	celeriac / cheese	J1x8	carrot / celeriac / potato / zucchini
S08	cabbage	R3	beet root / potato / carrot / zucchini	G2	carrot / celeriac / cheese	J2x2	carrot / celeriac / potato
S1	carrot / cabbage / cucumber / onion / potato / leek	R5	beet root / potato / carrot / zucchini	G3	carrot	J2,5x2,5	carrot
S2/S3	lemon / carrot / mushroom / cabbage / potato / cucumber / zucchini / onion / leek / bell pepper			G5	cabbage / cheese	J2x4	carrot / beet root / zucchini / potato
S4/S5	zucchini / beet root / carrot / mushroom / cucumber / bell pepper / radish / lettuce / potato / leek / tomato					J2x6	carrot / beet root / zucchini / potato
S8/S10	zucchini / potato / zucchini / carrot					J2x10	carrot / beet root / zucchini / potato / celeriac
S14	potato / zucchini / carrot					J4x4	eggplant / beet root / zucchini / potato
S20mm	melon / potato / zucchini					J6x6	eggplant / beet root / celeriac / zucchini / potato
S25mm	melon / potato / zucchini					J8x8	celeriac / potato

DICE	
D 5x5	carrot / zucchini / cucumber / celeriac
D 8x8	potato / carrot / zucchini / beet root
D 10x10	potato / carrot / zucchini / beet root / turnip / onion / apple
D 12x12	potato / carrot / zucchini / beet root / turnip / onion / apple
D 14x14	potato / carrot / zucchini / turnip / celeriac
D 20x20	potato / carrot / zucchini / pineapple / turnip
D 25x25	potato / zucchini / turnip / apple / melon / watermelon
D 50x75	salad

FRENCH FRIES

F 8x8	potato
F 10x10	potato
F 10x16	potato

CLEANING



WARNING

As a precaution, always unplug your appliance before cleaning it (risk of electrocution).

After removing the head of the vegetable preparation machine, take off the disc, followed by the grid and discharge plate where necessary.

Dishwashers are best avoided in order to prevent the aluminium from becoming tarnished. Instead we recommend that you clean the machine by hand using washing-up liquid.

If you do put your machine in a dishwasher, we suggest that you use a detergent designed specially for aluminium.

Metal-Safe detergents are available from detergent suppliers.

Never immerse the motor base in water. Clean it with a damp cloth or sponge.

IMPORTANT

Check that your detergent is suitable for cleaning plastic parts. Some washing agents are too alkaline (e.g. high levels of caustic soda or ammonia) and totally incompatible with certain types of plastic, causing them to deteriorate rapidly.

MAINTENANCE

• MOTOR SEAL

The motor seal on the shaft should be lubricated regularly using a food safe lubricant.

In order to keep the motor completely watertight, it is advisable to check the motor seal regularly for wear and tear and replace if necessary.

The motor seal can be easily replaced without having to remove the motor, so we strongly advise you to ensure that is in good condition.

• BLADES AND PLATES

The blades on all our discs are wearing parts that need to be replaced from time to time, in order to maintain consistently high cutting quality.

• GRATING DISCS

Grating discs deteriorate over time. We recommend you replace them from time to time, in order to maintain consistently high cutting quality

TECHNICAL SPECIFICATIONS

• WEIGHT (lbs)

	Net	Gross
CL 55 without a trolley	60	73
Motor base	40	42
Pusher feed-head	20	31
Hole feed-heads	19	23
Automatic feed-head	13	15
Stainless steel stand	22	23
Disc	1.1	1.3

• WORKING HEIGHT

The CL 55 is mounted on a stainless-steel base, which we advise you to place on a stable surface.

The included stainless steel stand positions the machine at the ideal working height.

• NOISE LEVEL

The equivalent continuous sound level when the CL 55 is operating on no-load is less than 70 dB (A).

SAFETY

WARNING

The discs are extremely sharp. Handle with care. Always use cutting gloves.

The CL 55 is fitted with magnetic safety system which stops the motor as soon as the large hopper or lid is opened, thus preventing any access to the cutting tool while it is in motion.

As soon as the lid opens, the motor stops.

To restart your machine, simply relock the lid and press the green switch.

When using the hopper equipped with a lever, the motor is stopped as soon as the lever is removed from the bowl. To start the machine again, you should simply position the lever at the aligned with the base of the bowl.

The CL 55 is fitted with a **temperature fuse** which automatically stops the motor if the machine is left on for too long or overloaded. If this happens, allow the machine to cool completely before restarting.

The hinge pin must be fitted in its position at the back of the motor unit before the machine is switched on.

REMINDER

Do not open the lid until the motor has come to a complete stop.

Never tamper with the locking and safety systems.

Never put a hard or non-food object in the bowl while the machine is operating.

Never force the ingredients down with your hands.

Do not overload the machine.

SERVICE

See warranty first then;

Should your unit requires service, check with your distributor to see where local service is available.

If not or if you wish your unit to be serviced at the factory, call for return instructions and ship the unit prepaid to our factory address.

PH : 1-800-824-1646

Robot-Coupe USA, Inc

Service Department Repair

264 South Perkins Street

Ridgeland, MS 39157

For service in Canada contact the Robot-Coupe USA factory for repair instructions.

robot  **coupe**[®]

TECHNICAL DATA

CL 52 Series E - CL 55 Series E

120V-60Hz Single phase

ESQUEMA CONEXIONES SCHEMA ELECTRIQUE

ELECTRIC DIAGRAM

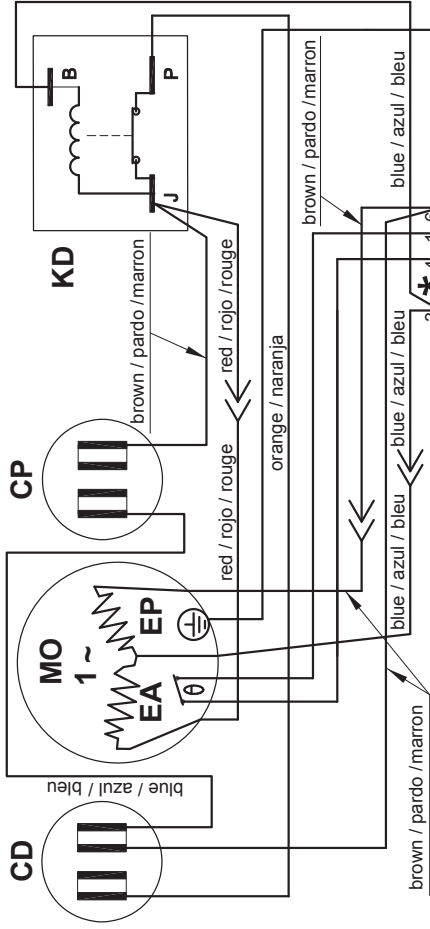

! Must be connected on the 120V tab.
Se debe conectar sobre el terminal 120V.
Doit être connecté sur la languette 120V.

Serial # : CL 52 Series E: from 453XXXXXX 03 F - MM
Serial # : CL 55 Series E: from 457XXXXXX 03 G - MM

English	Espanol	Français
C	Connector	Connecteur
CD	Starting capacitor	Condensador d'arranque
CP	Permanent capacitor	Condensador Permanente
DT	Circuit-breaker 15 A	Coupe-circuit 15 A
EA	Starting phase	Phase Auxiliaire
EP	Main phase	Phase Principale
ISC	Lid safety switch	Interruptor de seguridad tapa
ISP	Pusher safety switch	Interruptor de seguridad boton
ISP2	Pusher safety switch Only CL55 Series E	Interruptor de seguridad boton Únicamente CL55 Series E
KD	Starting relay	Rele d'arranque
MO	Single phase Motor	Motor monofasico
PCB	Control Board # 102481	Platina Réf. 102481
SAR	Off switch	Boton pulsador de parada
SMA	On switch	Boton pulsador d'arranque
θ	Motor thermal protector	Protector termico del motor

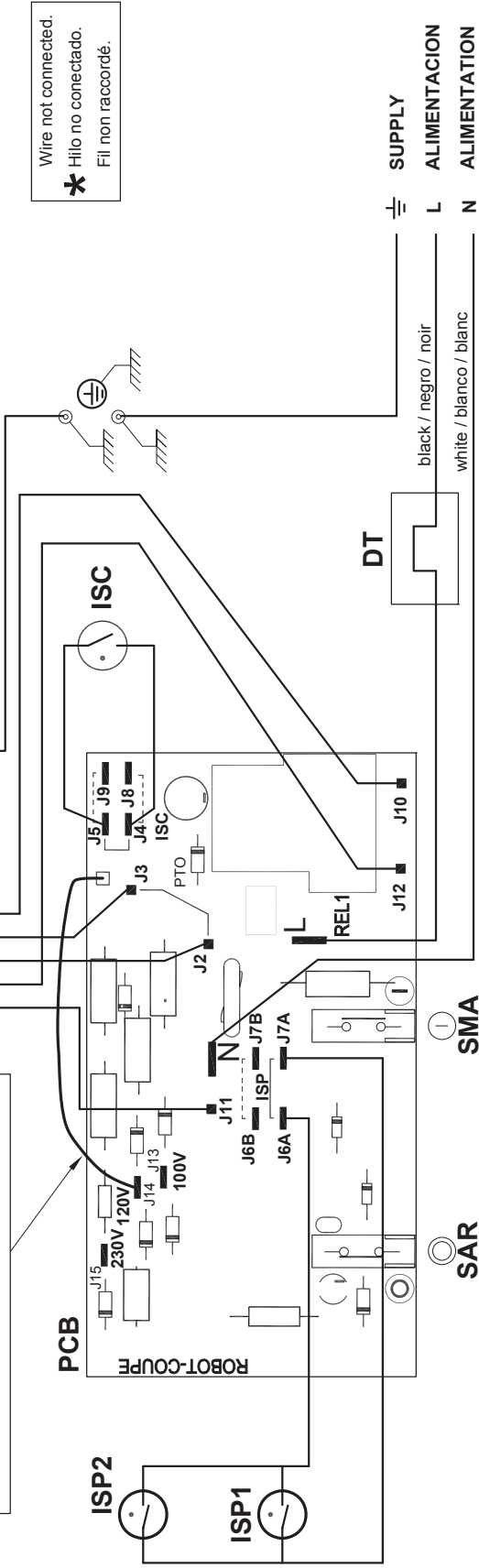

robotcoupe

N° 410343 d

Maj : 02/14



robot coupe®

Robot Coupe U.S.A., Inc.,

Phone: 800/824-1646 • 601/898-8411
264 South Perkins St., Ridgeland, MS 39157

e-mail: info@robotcoupeusa.com
website: www.robot-coupe.com

