

robot coupe[®]

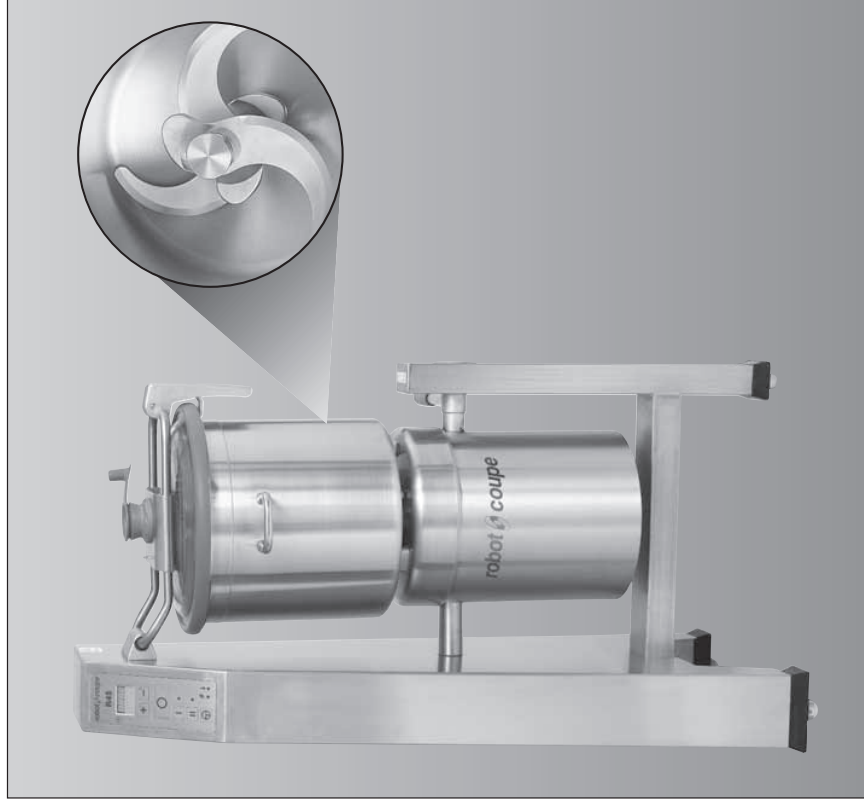

- **R 23 / Blixer[®] 23**
- **R 30 / Blixer[®] 30**
- **R 45 / Blixer[®] 45**
- **R 60 / Blixer[®] 60**

Robot Coupe U.S.A., Inc.
264 South Perkins, Ridgeland, MS 39157
Phone: 800/824-1646 • 601/898-8411
email: info@robotcoupeusa.com - website: www.robot-coupe.com

SUMMARY

WARRANTY

IMPORTANT WARNING

INTRODUCING THE NEW VERTICAL CUTTER-MIXER R 23 • R 30 • R 45 • R 60 and THE NEW EMULSIFIER-MIXER BLIXER® 23 • BLIXER® 30 • BLIXER® 45 • BLIXER® 60

ASSEMBLY

SWITCHING ON THE MACHINE

- Advice on electrical connections
- Control panel
- Powering up the machine
- Safety indicator lights

HELPFUL TIPS

- Emptying the bowl
- Blade assemblies vertical cutter mixer
- Blade assemblies Blixer®

MAXIMUM PROCESSING CAPACITIES

FITTING AND USING THE BLADE ASSEMBLY

- Blixer® only
- Vertical cutter mixers only

OPERATING INSTRUCTIONS FOR THE VACUUM KIT R-VAC®

VERTICAL CUTTER MIXER OPTIONS

- Coarse serrated blades
- Fine serrated blades
- Wheels
- R-VAC® vacuum kit

EXAMPLES OF USE

CLEANING

- Bowl
- Blades
- Lid

MAINTENANCE

- Blades
- V-Ring seals
- Bowl seal
- Lid seal
- Blixer scraper arm

DIAGNOSTIC SYSTEM

TECHNICAL SPECIFICATIONS

- Bowl capacities
- Weight
- Installation
- Noise level

SAFETY

SERVICE

TECHNICAL DATA

- Motor sleeve replacement
- Electrical and wiring diagrams

ROBOT COUPE U.S.A., INC. LIMITED WARRANTY

YOUR NEW ROBOT COUPE PRODUCT IS WARRANTED TO THE ORIGINAL PURCHASER FOR A PERIOD OF ONE YEAR FROM THE DATE OF PURCHASE.

This LIMITED WARRANTY is against defects in the material and/or workmanship, and includes labor for replacement of defective parts, provided repairs are performed by an authorized service agency (see attached list).

The Customer must inform the Service Agency of the possibility of warranty coverage and provide a copy of the dated sales or delivery receipt BEFORE WARRANTY REPAIRS ARE BEGUN.

Replacement parts and accessories are warranted for ninety (90) days from the date of purchase when purchased separately and will be verified by dated sales receipt OR packing slip which lists that item.

All parts or accessories replaced under warranty must be returned to the Service Agency.

THE FOLLOWING ARE NOT COVERED BY THE ROBOT COUPE U.S.A. INC LIMITED WARRANTY :

- 1 -** Damage caused by abuse, misuse, dropping, or other similar damage caused by or resulting from failure to follow assembly, operating, cleaning, user maintenance or storage instructions.
- 2 -** Labor to sharpen and/or replacements for blades that have become blunt, chipped or worn after a normal or excessive period of use.
- 3 -** Materials or labor to replace or repair scratched, stained, chipped, pitted, dented or discolored surfaces, blades, knives, attachments or accessories.
- 4 -** Any alteration, addition, or repair that has not been carried out by the company or an approved service agency.
- 5 -** Transportation of the appliance to or from an approved service agency.
- 6 -** Labor charges to install or test new attachments or accessories (i.e., bowls, plates, blades, attachments), which have been replaced for any reason.

7 - The cost of changing direction-of-rotation of three-phase electric motors (Installer is responsible).

8 - SHIPPING DAMAGES. Visible and/or hidden damage is the responsibility of the freight carrier. The consignee must inform the carrier and consignee immediately, or upon discovery in the case of hidden defects.

KEEP ALL ORIGINAL CONTAINERS AND PACKING MATERIALS FOR CARRIER INSPECTION.

Neither ROBOT COUPE U.S.A., INC. nor its affiliated companies or any of its distributors, directors, agents, employees, or insurers will be liable for indirect damage, losses, or expenses linked to the appliance or the inability to use it.

The ROBOT COUPE U.S.A., INC. warranty is given expressly and in lieu of all other warranties, expressed or implied, for merchantability and for fitness toward a particular purpose and constitutes the only warranty made by ROBOT COUPE U.S.A., INC..

IMPORTANT WARNING

WARNING
KEEP THESE INSTRUCTIONS
IN A SAFE PLACE

WARNING: In order to limit accidents such as electric shocks, personal injury or fire, and in order to limit material damage due to misuse of the appliance, please read these instructions carefully and follow them strictly. Reading the operating instructions will help you get to know your appliance and enable you to use the equipment correctly. The operation manual should be kept within easy access to all users for reference and should be read completely by all first time users of the machine.

UNPACKING

- Carefully remove the equipment from the packaging and take out all the boxes or packets containing attachments or specific items.
- **WARNING**-some of the parts are very sharp e. g. blades ... etc.

INSTALLATION

- Install your machine on a stable solid base.

CONNECTION

- Always check that your power supply corresponds to that indicated on the serial number plate and that it is properly sized.

HANDLING

- Always wear cut-resistant gloves when handling the cutting blades.

SPECIFICATIONS

Model	Motor	Speed (rpm)	Rated current (Amp)	Minimum branch* circuit protection required (A)
R 23 Bliker® 23	208-240 V/60Hz/3ph	1800 3600	16.0 18.2	30
R 30 Bliker® 30	208-240 V/60Hz/3ph	1800 3600	18.6 23.1	40
R 45 Bliker® 45	208-240 V/60Hz/3ph	1800 3600	27.0 35.0	60
R 60 Bliker® 60	208-240 V/60Hz/3ph	1800 3600	32.5 45.0	60

* Recommendation only, local electrical codes must be followed if applicable.

- **Power shown on data plate.**

ASSEMBLY PROCEDURES

- Follow the various assembly procedures carefully (see page 6) and make sure that all the attachments are correctly positioned.

DIMENSIONS (in inches)

	R 23 Bliker® 23	R 30 Bliker® 30	R 45 Bliker® 45	R 60 Bliker® 60
A	49 ¼	49 ¼	55 ¼	55 ¼
B	12 ¾	14 ¼	15 ¾	17 ¾
C	23 ¾	23 ¾	23 ¾	23 ¾
D	23 ¾	23 ¾	25 ¼	25 ¼
E	64	64	71	71 ¾
F	31 ¼	31 ½	34 ¼	34 ¼
G	27 ¾	28 ½	30	32

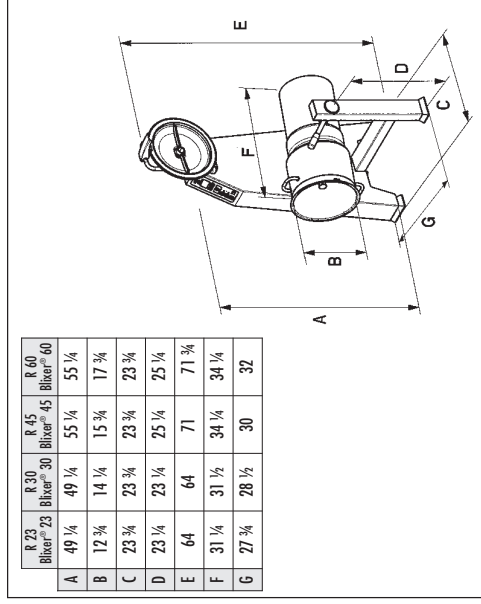

- The blades are sharp. Wear cut-resistant gloves when handling the blades.

CLEANING

- Always unplug your appliance before cleaning.
- Always clean the appliance and attachments at the end of each use.
- For parts made of aluminum alloys, use cleaning detergents suitable for aluminum. Presently, there are no aluminum alloys on the surface of the machine.
- Do not spray or pressure-wash the machine.
- For plastic parts, do not use detergents that are too alkaline (i.e., containing too much caustic soda or ammonia...).

MAINTENANCE

- Always unplug the appliance before servicing.
- Check the seals regularly and ensure that the safety devices are in good working order.
- It is particularly important to maintain and check the attachments since certain products contain corrosive agents e.g. citric acid.
- **NOTICE:** Never operate the appliance if the power cord or plug has been damaged. If the machine fails to operate as described in this manual, or if the machine malfunctions in any way, remove the machine from use and have it serviced. Additionally, discard all food processed at the time of the malfunction.
- Contact your local Authorized Service Agency if something appears to be wrong.

USE

- Do not open the bowl lid until the blade have come to a complete stop.
- Never tamper with or defeat the purpose of the locking and safety systems.
- Never put a hand or nonfood object into the bowl.
- Do not overload the machine.

INTRODUCING THE NEW VERTICAL CUTTER-MIXER R 23 • R 30 • R 45 • R 60 and THE NEW EMULSIFIER-MIXER BLIXER® 23 • BLIXER® 30 • BLIXER® 45 • BLIXER® 60

The vertical cutter and the Blixer® run at two speeds: **1800 RPM and 3600 RPM** (North America 60 Hz power). The vertical cutter will prepare meat, vegetables, smooth-textured stuffings and mousses, as well as for grinding, kneading and so on - with a maximum processing time of five minutes for the longest jobs. The Blixer® will make it easy to prepare mixed liquid or semi-liquid, raw or cooked meals. Its numerous functions will open the door to a whole new culinary world.

Thanks to your appliance's simple design, all components requiring frequent handling for maintenance or cleaning can be fitted and removed with the greatest of ease.

For optimum convenience, this manual describes the various fitting operations on a step-by-step basis.

It places special emphasis on explaining the various actions that cause the motor to stop, as the appliance is equipped with safety devices which prevent access to the cutting assembly until it has come to a complete standstill.

This manual contains important information designed to help you get the most out of your vertical cutter-mixer.

We therefore recommend that you read this carefully before using your appliance.

We have also included examples of a few processing tasks to help you get the feel of your new appliance and appreciate the full range of its many useful features.

ASSEMBLY

1) With the appliance facing you, position the bowl directly above the motor shaft. Lower it so that the bowl is centred on its base.



2) Push down on the handles, rotating the bowl firmly in an anticlockwise direction until it is locked into position. **The handles should now be facing you on either side of the bowl.**

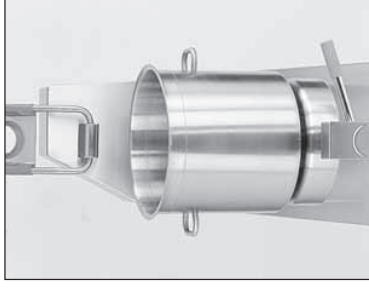

3) Place the blade assembly on top of the motor shaft.

Then lower it to the bottom of the bowl by rotating it. Always check that the blade assembly is correctly **positioned at the bottom of the bowl** before placing the ingredients you wish to process in the bowl.

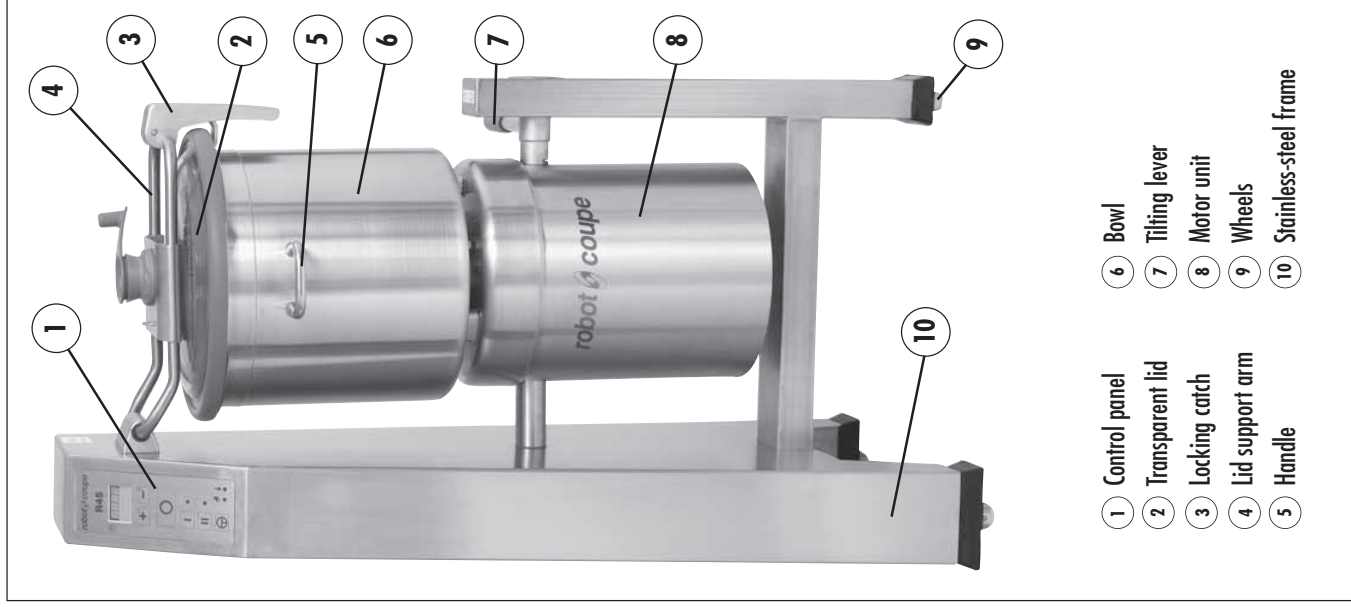
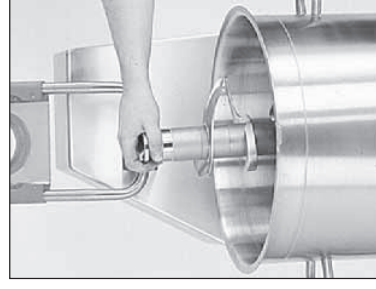

- | | | | |
|---|-----------------|----|-----------------------|
| 1 | Control panel | 6 | Bowl |
| 2 | Transparent lid | 7 | Tilting lever |
| 3 | Locking catch | 8 | Motor unit |
| 4 | Lid support arm | 9 | Wheels |
| 5 | Handle | 10 | Stainless-steel frame |

4) Clip the lid onto the lid rest and turn it so that the bosses are inside the arm.

The logo should now be facing you, lined up with the handle, with the safety magnet on the right.

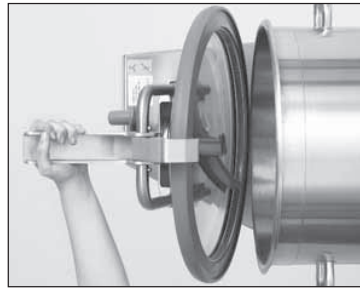
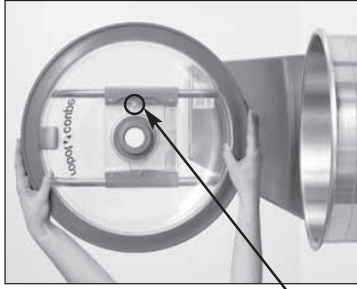

5) To close the lid, fit the locking catch over the edge of the bowl and push the handle down.



• BLIXER SCRAPER ARM Assembly

Hold the scraper arm in one hand and the handle in the other. Press the two parts together in the centre of the lid, then rotate the handle 45° in an anticlockwise direction.



SWITCHING ON THE MACHINE

• ADVICE ON ELECTRICAL CONNECTIONS

Before plugging in, check that your power supply corresponds to that indicated on the machine's serial number plate.



WARNING

This appliance must be plugged into an earthed socket (risk of electrocution).

These models must be powered from a
208-240 V / 60 Hz

3 Phase power supply.

The machine is supplied with a power cord and a plug attachment. If wiring to a service disconnect box, this should be undertaken by a qualified electrician.

The power cord has four wires, one grounded wire, plus three phase wires.

Connect the green wire to the ground terminal pin.

These machines do not require a neutral connection.



DANGER : RISK OF INJURY

The blades are extremely sharp.

For this reason, always make sure you have removed the blade assembly before doing any job inside the bowl, such as cleaning or emptying.

• LID WIPER Assembly - VERTICAL CUTTER MIXER

Hold the lid wiper in one hand and the handle in the other. Press the two parts together in the centre of the lid, then rotate the handle 45° in an anticlockwise direction.

• **CONTROL PANEL**

- **Dual-speed machines**

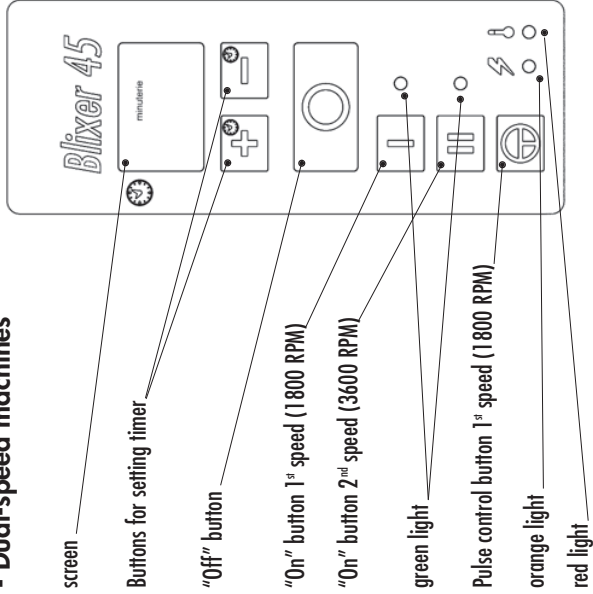

• **POWERING UP THE MACHINE**

- **Start-up**

Stage 1

Each time the machine is powered up, the message « Cx Fyy » will appear on the screen:

- « x » will be a figure between 0 and 7, corresponding to the control board configuration.

- « yy » will be either "50" or "60", depending on whether the power supply has a frequency of 50 or 60 Hz.

Example: an R 45 ("2" configuration) operated at 50 Hz will display the following message:



Stage 4

The orange light will go out and the two green indicator lights will come on. The machine is now ready to use.

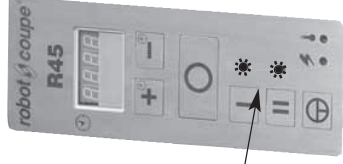

WARNING:

If you try to start the machine during one of the above stages by pressing the 1st or 2nd speed "ON" button, or even the "Pulse control" button, nothing will happen. A troubleshooting message (see table on page 18) will appear on the screen.

- **Standby**

If the machine is left powered up but unused for between 15 and 120 minutes, without any movement of any of its electrical elements (safety switch, "Off" button, etc.), the green lights will go out and the orange light will start to flash.

To quit standby: to reactivate the machine push a button or operate the lid.

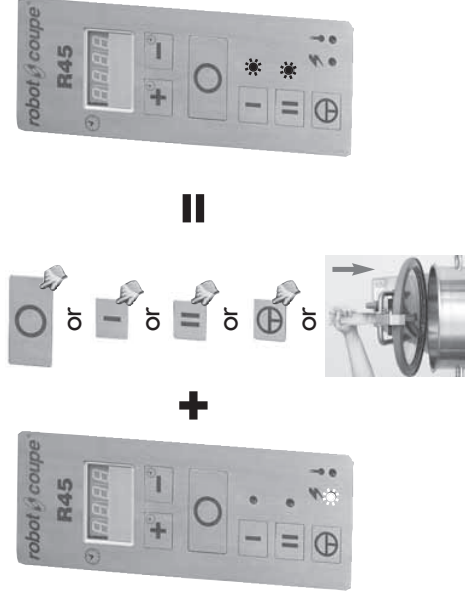

The orange indicator light will come on.

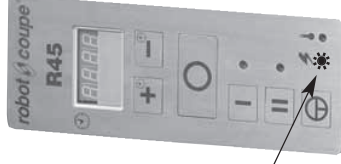

Stage 2

Open the lid, then close it again, to activate the safety system. The orange light will remain on.

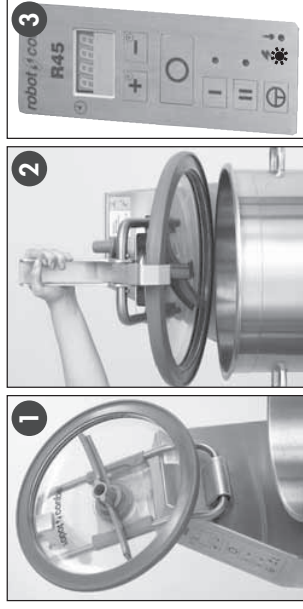

Stage 3

Press the "off" button, then release it. Make sure you only do this when "0.00" or another duration is displayed on the screen.

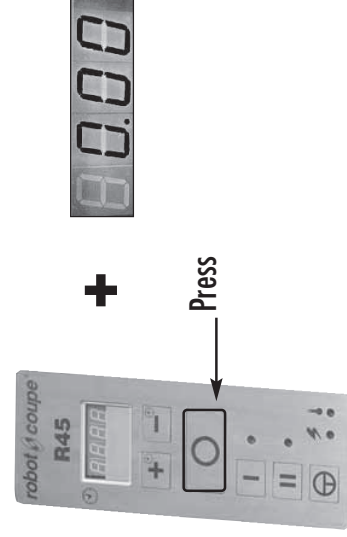

- Extended standby

If the machine is left powered up but unused for more than 2 hours, without any movement of any of its electrical elements (safety switch, "off" button, etc.), the green lights will go out and the orange light will start to flash.

To quit extended standby: push the O stop button and open then close the lid.

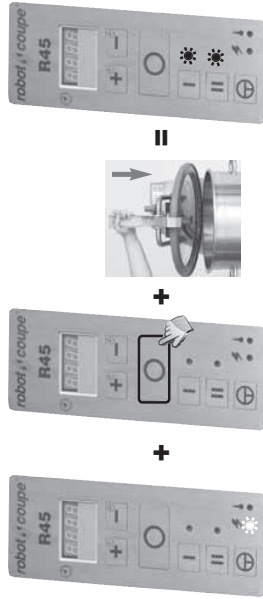

Wait for the red light to go out before beginning a new batch of product.

2

The red and orange lights will remain on until the motor has cooled down.

You must wait until the red and orange lights have gone out and the green light has come on before switching the machine back on.



HELPFUL TIPS

• EMPTYING THE BOWL



1) Open the lid by freeing the locking handle. Release the tilting lever by raising it.

2) Then tilt the bowl to your left, keeping hold of the handle on the right.



3) Empty the bowl once it is in the tilted position. It is advisable to remove the blade assembly before tilting the bowl, especially when processing liquid preparations.

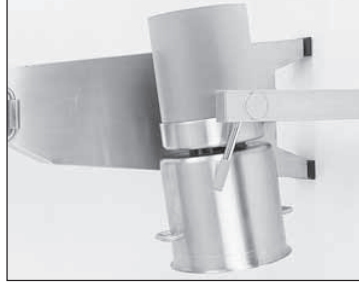

• BLADE ASSEMBLIES VERTICAL CUTTER MIXER

In order to ensure optimum cutting quality, Robot-Coupe has developed new, patented blade profiles.

These blades, which are perfectly balanced in order to avoid any vibration, are supplied with three different types of edge.

Standard blade :

Smooth edge for emulsions, mousses and finely-chopped meat and vegetables.



Optional blades :

Fine serrated edge for all blending tasks and smooth or fine-textured preparations.



Coarse serrated edge for cake-making (grinding almonds and hazelnuts, making icing sugar), for frozen berries and all hard foodstuffs.



• SAFETY INDICATOR LIGHTS:

For the dual-speed models:

Two green lights indicate that the machine is ready to use.

- **Orange light:** the machine is powered up, but the safety criteria have not all been met. The screen will display a troubleshooting message (see table on page 18).

- **No lights:** the machine is either not powered up, has the wrong power supply, or has broken down.

- Red light:

1

The machine's motor has reached a temperature of 120 °C. The motor will shortly cut out. This light allows you to anticipate the machine switching itself off in the middle of a processing task.



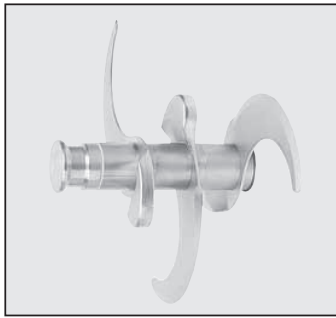

Smooth, “**crested-shaped**” 3-blade assembly, supplied as a **standard attachment**.

Distinctive feature : the “**crested**” blades make it easier to **mix and bind ingredients**.

A 2-blade assembly is used for processing small quantities or liquid preparations. The 3-blade assembly is used for maximum capacities with dry ingredients.

To obtain the best results, it is important to set the right spacing between the blades. Do not exceed maximum processing capacities (see following table).

• **BLADE ASSEMBLIES BLIXER®**

In order to minimize vibration and to ensure optimum cutting quality, Robot Coupe has developed a new patented blade design.



Fine serrated edge for all blending tasks and smooth or fine-textured preparations.

The standard blixer blade assembly.

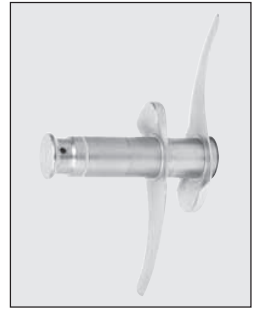

To obtain the best results, it is important to get the spacing between the blades right and to take into account the maximum processing capacities (see table).



MAXIMUM PROCESSING CAPACITIES

The subject of **maximum processing capacities** will be discussed a little later. These quantities are given in the table below.

Quantities are given in pounds.

TYPE OF PREPARATION	Vertical Cutter Mixer			
	R 23	R 30	R 45	R 60
Coarse chopping	22	26	40	55
Emulsion	24	31	53	66
Kneading (in lb of flour)	15	17	26	39
Grinding	11	13	20	25

Maximum processing capacities	Blixer®			
	23	30	45	60
Maximum processing capacities	9 to 34 Lbs	9 to 44 Lbs	13 to 66 Lbs	13 to 100 Lbs
Liquids at low speed	16	21	31	42

FITTING AND USING THE BLADE ASSEMBLY

• BLIXER® ONLY

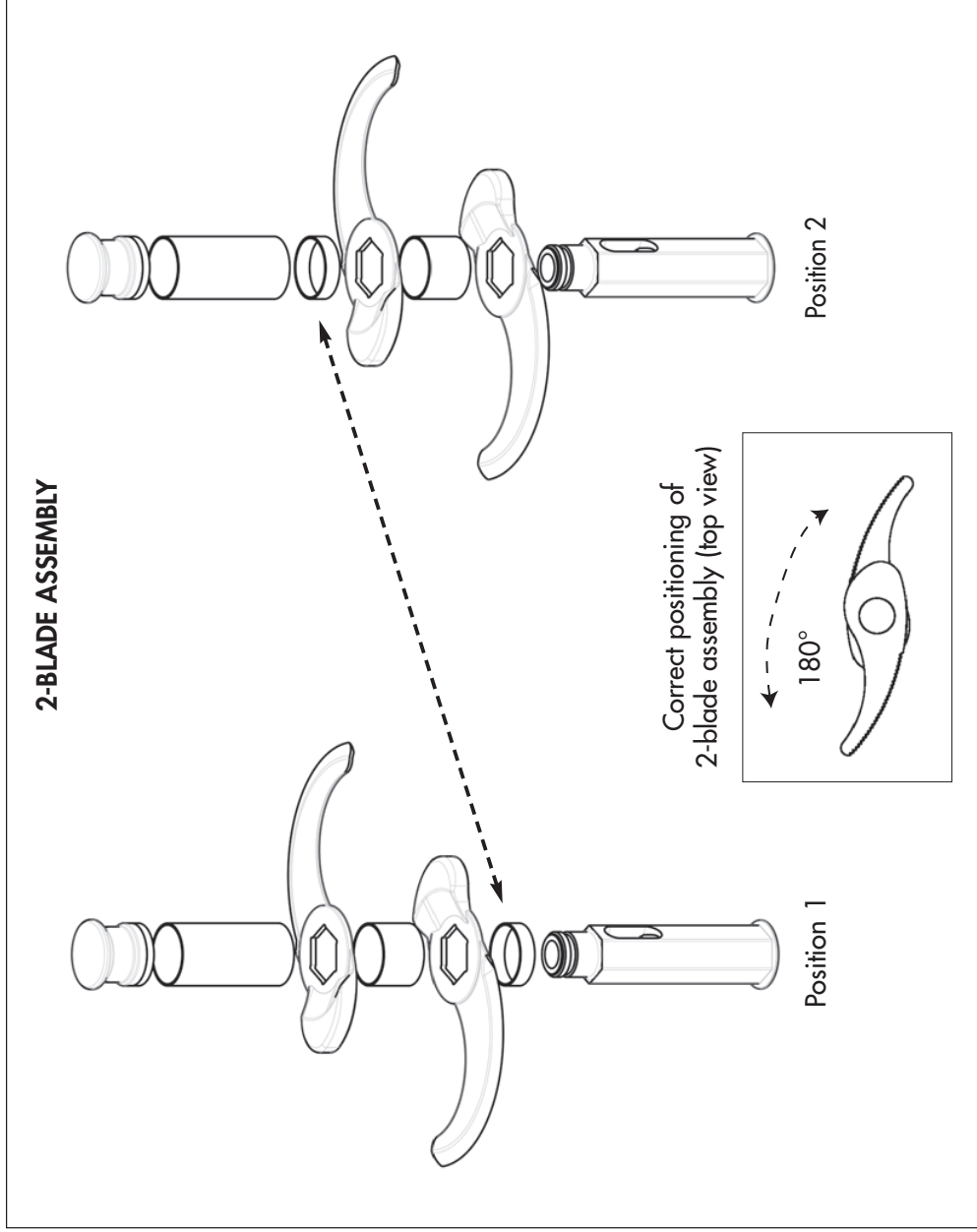

Screw nut



Locking spacer



Wide spacer



Narrow spacer

POSITION 1: With spacer between lower blade and blade shaft.

FITTING:

- Fit the blades and spacers so that they are the right distance apart, according to the:
 - type
 - weight and
 - volume of the foodstuffs to be processed.

POSITION 2: No spacer between lower blade and blade shaft.

- For **fine chopping and emulsions.**

DISMANTLING:

- Unscrew the screw nut
- Remove the spacers.



Blade shaft



Blade

• VERTICAL CUTTER MIXERS ONLY

• 2-BLADE ASSEMBLY :

We recommend you use the 2-blade assembly for processing small quantities of up to half the maximum limit indicated (see page 9), with the exception of liquid or blended preparations.

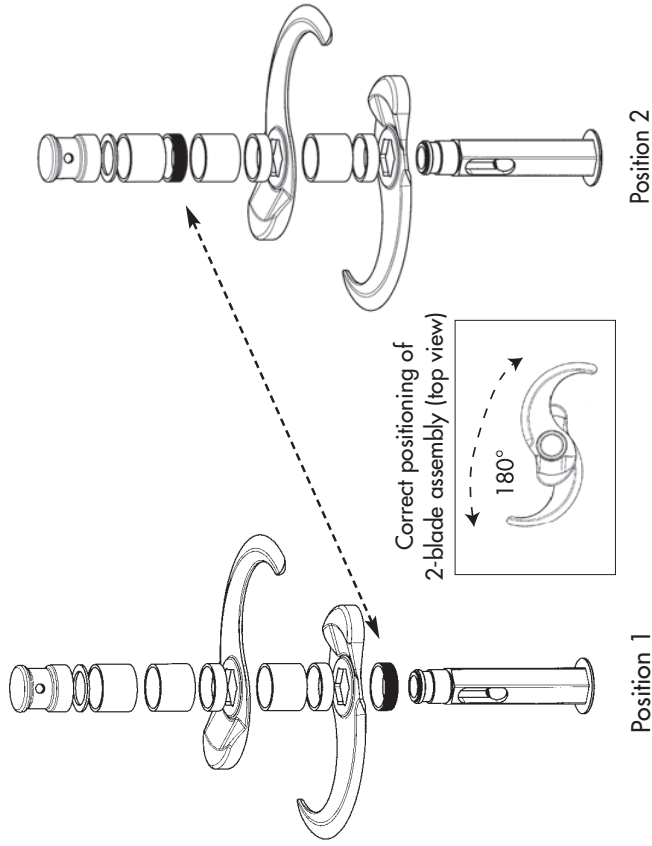

• 3-BLADE ASSEMBLY :

We recommend you use the 3-blade assembly for processing large quantities of more than half the maximum limit indicated, with the exception of liquid or blended preparations for which we strongly recommend you use the 2-blade assembly.

To obtain the best possible results with these types of preparation, we recommend you use the lower speed (1500 rpm) only.

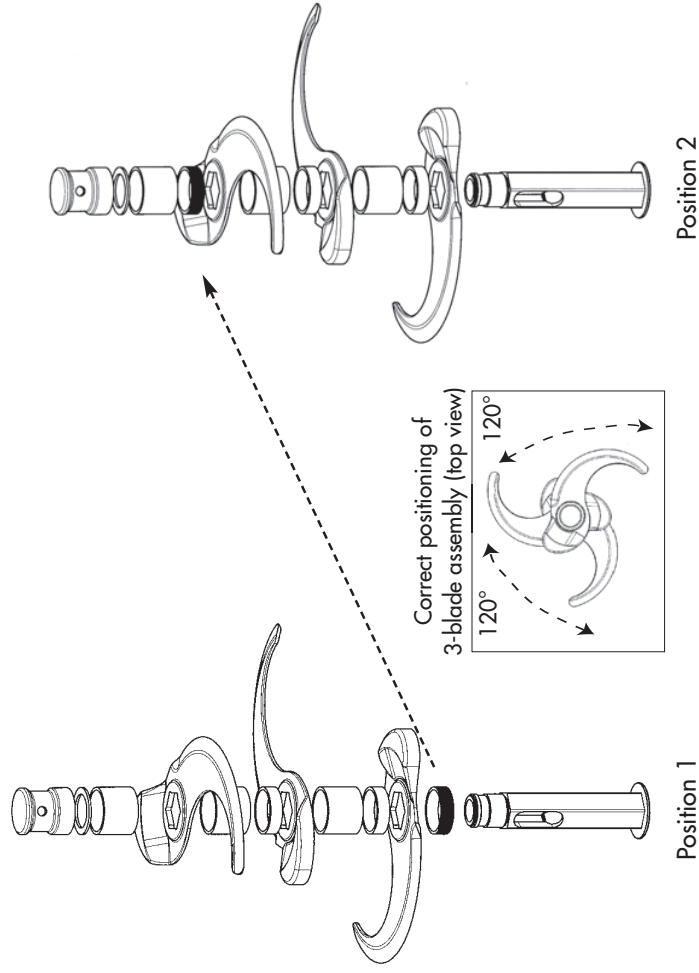

POSITION 1 : With spacer between lower blade and blade shaft.

- FITTING :**
- For **coarse chopping**.
 - Fit the blades and spacers so that they are the right distance apart, according to the :
 - type
 - weight and
 - volume of the foodstuffs to be processed.

POSITION 2 :

No spacer between lower blade and blade shaft.

- For **fine chopping and emulsions**.
 - For **grinding and kneading**.
- DISMANTLING :**
- Unscrew the screw nut
 - Remove the spacers.



Screw nut



Wide spacer



Narrow spacer



Locking spacer



Blade



Blade shaft

OPERATING INSTRUCTIONS FOR THE VACUUM KIT R-VAC®

VERTICAL CUTTER MIXERS ONLY

1° ASSEMBLING THE VACUUM KIT R-VAC®

- Insert filter **2** into body **3**
- Screw the tube **1** onto the body **3** (the tube should pass through the body **3**).

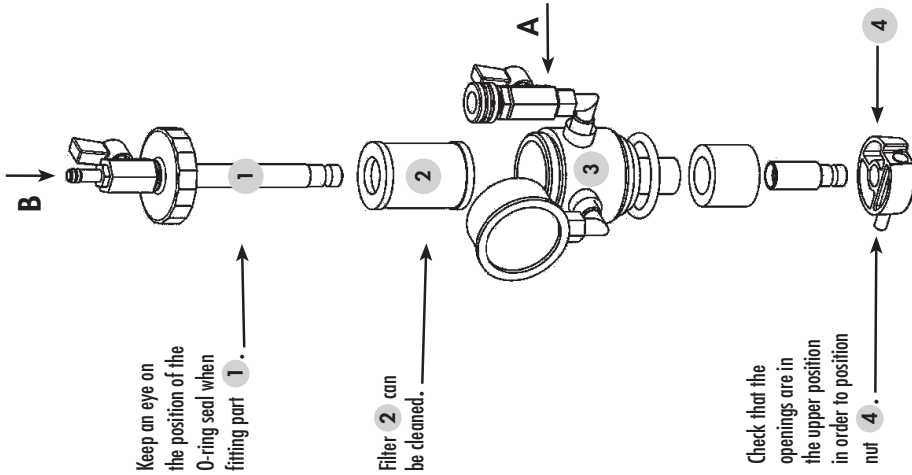

5° ADDING LIQUID TO THE MIXTURE

- Attach a tube to valve **B**.
- Immerse the other end of this tube in the liquid to be added.
- Open valve **B** slowly ; once the liquid has been added, shut valve **B**.

2° POSITIONING THE R-VAC® VACUUM KIT ON THE LID

- Sit the R-VAC® kit on top of the plastic cone **5**, which should be screwed onto the lid rest **6**, with the lid holder **8** in between. The lid (opaque white) **9** slots onto the lid rest **6**.

3° CLIPPING ON THE BELL **4**

- Take the bell in the hollow of your hand and press the pusher **7** in with your thumb.
- Slot it onto the section of tube **1** protruding from the underside of the lid.
- Release the pusher **7**.
- The pusher should return to its initial position. If it does not, gently press on the bell and it will automatically click into place.
- Check that the bell is securely attached to the tube **1**.

4° USING THE VACUUM KIT R-VAC®

- Connect up the vacuum pump to valve **A**, check that the latter is open (lever in shaft of connector).
- Shut valve **B** (perpendicular lever).

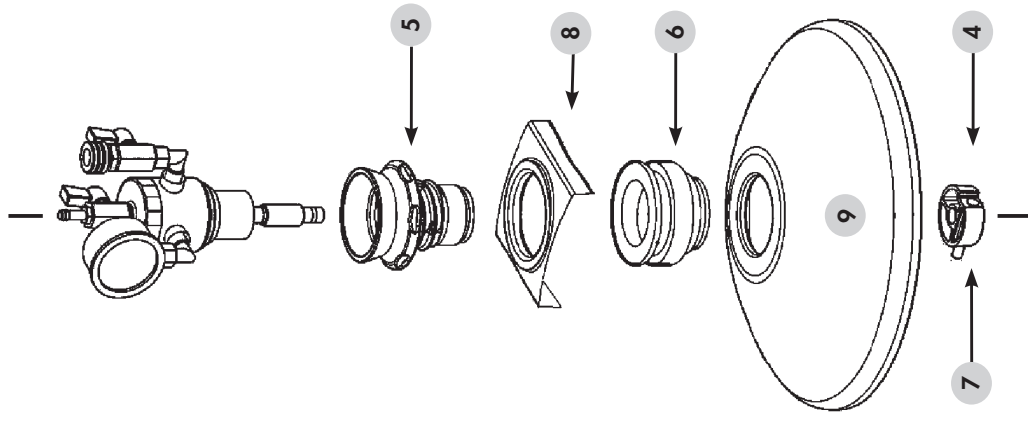

NOTE



Preheat the vacuum pump (approx. 15 minutes) to check that both it and the vacuum kit are working properly. Similarly, leave the pump running for 15 minutes after completing the task in order to evacuate the condensation.

VERTICAL CUTTER MIXER OPTIONS

• COARSE SERRATED BLADES



The blade shaft can be fitted with serrated blades, which are used mainly for: - kneading (shortcrust pastry, flan pastry, almond paste, praline, etc.). - grinding (frozen berries, shellfish, almonds, etc.).

• FINE SERRATED BLADES

The blade shaft can also be fitted with micro-toothed blades, which are used mainly for chopping herbs (e.g. parsley) and blending.



• WHEELS

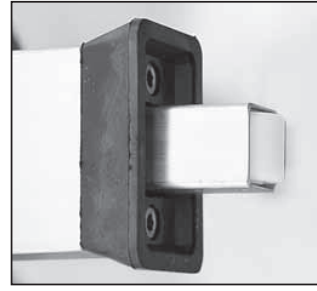

Your cutter can be supplied with 3 retractable wheels (exclusive to ROBOT-COUCPE) which can be lowered or raised simply by lifting each leg. This makes it easy to move the machine around and thereby facilitates the cleaning of the working surfaces.

• R-VAC® VACUUM KIT

Your machine can be equipped with a vacuum kit. Vacuum processing gives incomparable results for all types of preparations, ranging from fish mousses, fine-textured stuffings and vegetable terrines to foie gras and ganache.



Make sure you always use the opaque white lid with the vacuum kit.

EXAMPLES OF USE

• VERTICAL CUTTER MIXER

The cutter will enable you to perform all your cutting tasks in minimum time. We recommend therefore, that you keep a close eye on the mixture in order to obtain the desired results.

USES (lbs)	R 23	R 30	R 45	R 60
CHOPPING				
• MEAT				
Minced beef	22	25	40	55
Sausage meat / tomate stuffing	22	26	40	55
Terrine / saucisson	26	31	48	66
White pudding / liver mousse*	28	35	53	73
Smooth-textured mixtures (frankfurters)	17	22	31	40
• FISH				
Purèed fish*	28	35	53	73
Fish stuffings*	28	35	53	73
• VEGETABLES				
Garlic / parsley / onion / shallots	half bowl volume			
Soup / vegetable purées*	37	46	70	97
• FRUIT				
Compotes / fruit purées	28	35	53	73
EMULSIFYING				
Mayonnaise / aioli / taramasalata	28	35	53	73
Rémoulade sauce	28	35	53	73
Snail / salmon butter	17	22	35	60
KNEADING				
Shortcrust / biscuit pastry				
Flaky pastry	12	16	27	38
Pizza / bread dough				
Brioche dough	11	13	21	26

USES (lbs)	R 23	R 30	R 45	R 60
	GRINDING			
Almond paste	13	17	26	37
Praline	24	31	44	62
Seafood / crushed ice	11	13	20	26
Breadcrumbs	13	15	24	33
BLENDING				
Liquid preparations*	35	44	66	88

* In low speed only

The vertical cutter-mixer has numerous other applications. The above quantities are given for guidance only and may vary according to the quality of ingredients or the recipe.

• BLIXER®

The cutter will enable you to perform all your cutting tasks in minimum time. We recommend therefore, that you keep a close eye on the mixture in order to obtain the desired results.

HOSPITAL USES	
SPOON FEEDING	<ul style="list-style-type: none"> • Minced foods: meat, fish etc. • Vegetable purees • Mousses: vegetables, fish etc. • Compotes of stewed fruit
SEMI-LIQUID FEEDING	<p>This simply entails diluting spoon-feeding preparations:</p> <ul style="list-style-type: none"> • Minced meat + gravy • Puree + liquid (broth, milk, etc.) • Soups / creamed soups • Fruit compotes + syrup or water
LIQUID FEEDING (for use via tubes)	<ul style="list-style-type: none"> • Soups and any preparations that can be liquidized.
DELICATESSEN USES	
• Butter mixtures: snail butter, salmon butter, anchovie butter...	
• Sauces: green sauce, mayonnaise, remoulade, aïoli, emulsified sauces with tomatoes, cream, parsley...	
• Vegetable mousses.	
• Grinding: lobster, scampi, seashells...	
PHARMACEUTICAL AND CHEMICAL LABORATORY USES	
• Grinding: herbs, seeds, powders, tablets...	
• Mixing: homogenization of creams, ointments, mixed components, varied ingredients...	

CLEANING



W A R N I N G

As a precaution, always unplug your appliance before cleaning it (hazard of electrocution) and handle the blades with care (hazard of injury).

• BOWL

Once the bowl is empty, return it to its vertical position, close the lid and run the machine at the 2nd speed (3,000 rpm). This will clear the blades of any food residue. You can also pre-clean the bowl by pouring in a few litres of hot water, then running the machine for a few minutes at the 2nd speed.

As all the electrical parts are watertight, this machine is extremely easy to clean. It can be washed daily with a hand shower spray (never use a power washer).

If you are not intending to use your appliance for a while, remember not to lock the bowl into position, to avoid unnecessary wear of the seals.

• BLADES

The blade assembly must be taken apart in order to thoroughly clean each part.

Blades must be cleaned each 4 hours or after each meal period



I M P O R T A N T

All the metal parts should be wiped dry, especially, the blades, to avoid oxidation.

These operations are vital for ensuring optimum blade assembly hygiene.

Dismantling the blade assembly



- Lift the blade assembly out of the appliance.
- Remove the bowl.
- Place the blade remover on the motor shaft.

- Put the blade assembly back in position.
- Loosen the screw using the hooked blade disassembly tool.
- Dismantle the blade assembly by hand.
- To reassemble the blades, follow these instructions in the reverse order.

- Make sure you tighten the screw properly after reassembling the blades, in order to prevent the latter coming loose.

• LID

For perfect hygiene, remove the washer, cone and lid rest so that they can each be carefully cleaned. We advise against putting them in the dishwasher. Instead, wash them by hand with a little mild liquid detergent.

If you are not intending to use your appliance for a while, leave the lid open to avoid wear and tear of the seals.

Removing the lid seal



1 - Unhook the lid from the arm.

2 - Put the lid the wrong way round on the bowl.

3 - Start to set the seal at the hinge side. Hold firmly the seal with the thumb and the index finger and insert it in the lid groove.

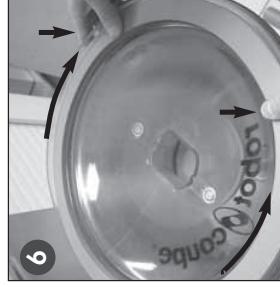
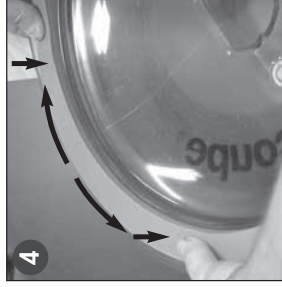
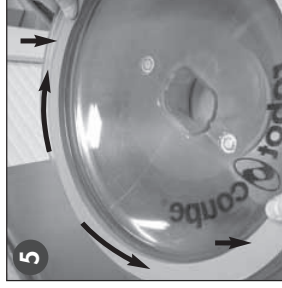
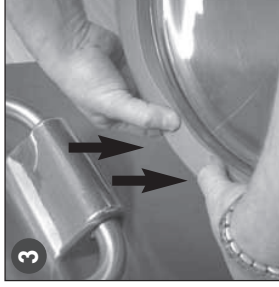

4 to 7 - Keep inserting the seal progressively on both sides in order to join both hands.

8 Clip the lid onto the lid rest and turn it so that the bosses are inside the arm.



↑ IMPORTANT
Check that your detergent is suitable for cleaning the plastic parts. Certain washing agents are too alkaline (e.g. high levels of caustic soda or ammonia) and totally incompatible with certain types of plastic, causing them to deteriorate rapidly.

MAINTENANCE

• BLADES

After each task, we strongly recommend you sharpen the blades briefly with a sharpening stone, especially after chopping parsley.

Sharpen them thoroughly once a month with the fine-textured sharpening stone supplied with the appliance.

The quality of the cut depends mainly on the sharpness of your blades and their degree of wear. The blades are wearing parts which should be replaced from time to time, in order to ensure consistent quality of the finished product.

• V-RING SEALS

The sealing sleeve comprises a stainless-steel part **1**, a stainless-steel deflector fitted with a friction ring **2** and 2 lip seals **3**.

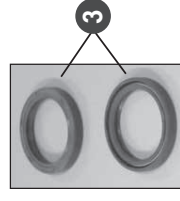
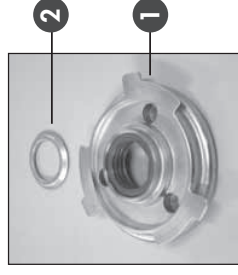

In order to ensure that the motor remains completely watertight, we recommend checking the lip seals once a quarter for signs of wear and tear, and replacing them every 6 months.

When the seals are worn, liquid may first run into the bearings, then reach the motor. If this happens, the seals, the bearings and even the motor may have to be replaced.

- Replacing the lip seals



1) Tools needed See kit supplied on delivery.

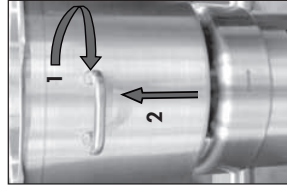

2) Remove the bowl

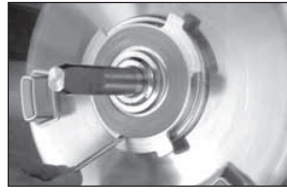

3) Remove the bowl base seal.



4) Unscrew the 3 bolts

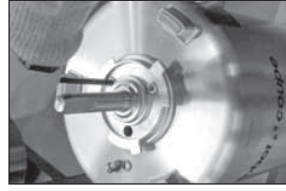

5) Remove bolts and washers

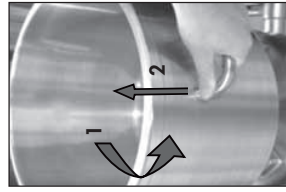

6) Put back the bowl and pull up

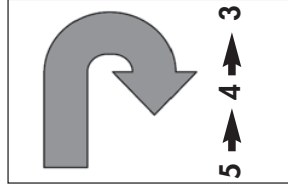

9) 5 to 3 in inverse order



8) Replace the two lip seals.



7) The stainless-steel part and deflector have now been removed.

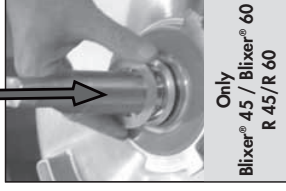

11) Place 1 mm thick washer



10) Replace the bowl seal, placing it on the chamfer.

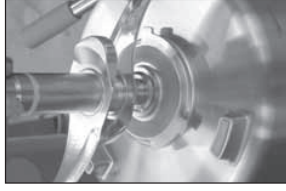

12) Push down blade assy, stop when hits motor shaft



14) Put back the bowl, pouring lip on left hand side

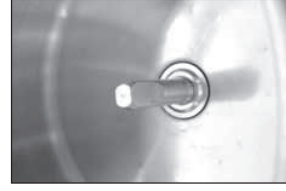

15) It's done !

• BOWL SEAL

The bowl seal, located between the bowl and the bus-hing, ensures that the bowl remains watertight.

The bowl seal must be regularly oiled, using food-grade silicone lubricant.

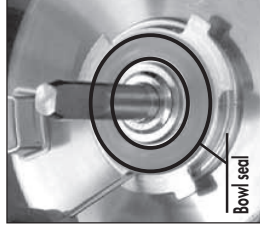

This part must be replaced each year, as the watertightness of the bowl depends on its degree of wear and tear.

In order to make it easier for you to clean your appliance, the bowl watertightness system is located on the underside of the bowl.

As a result, a small area here may fill up with foodstuff, though it will empty itself when the bowl is released.

• LID SEAL

The lid is designed to be completely watertight within the limits set out on page 12 (see examples of use). In order to ensure that it remains that way, you may have to change the seal occasionally, depending on how regularly you use your machine.

If you do not use your machine regularly, we recommend that you leave the lid open when it is not in use jobs to preserve all these features.

• BLIXER SCRAPER ARM

The scraper arm is fitted with rubber wipers. These are wearing parts, which therefore need to be replaced from time to time in order to maintain optimum efficiency.

The wipers are easy both to remove and to fit.

DIAGNOSTIC SYSTEM

• TROUBLESHOOTING MESSAGES

- « CLOS Lid » message



The appliance is powered up but the lid has been left open. Close the lid.

- « OPEn And CLOS Lid » message

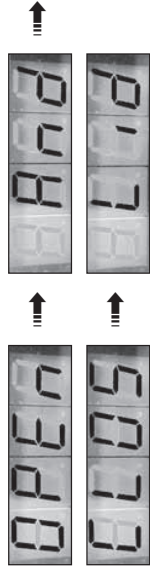

The appliance is powered up and the lid is closed. Open the lid and close it again.

- « PrES StOP » message



The screen will display this message in the following two cases:

- An attempt has been made to start the machine before Stage 3 is completed (see page 8). Wait for the screen to display "0.00", then press the "off" button.
- The appliance is powered up but unused, or has been running for more than two hours without the "off" button being pressed. Wait for the screen to display "0.00", then press the "off" button.

- « iSbC » message



This message indicates that the two lid arm safety switches ("iSbC") are not being detected.

Checks to be made in the following order:

- 1) Check that the lid has been closed properly.
- 2) Check that the two safety switches both move freely when the lid is opened and closed.
- 3) Check (with an ohmmeter) that the contacts of these two safety switches are both closed. Check the relevant wiring.

If the two switches are properly closed and this message remains on the screen, either get the control board checked over or have it replaced.

- « iSCO » message



The lid's magnetic safety switch ("iSCO") is not being detected.

Checks to be carried out in the following order:

- 1) Check that the lid and, more specifically, its magnet, are correctly positioned.
 - 2) Check (with an ohmmeter) that the safety switch's contact is closed. Check the relevant wiring. If necessary, remove the lid and place a sufficiently powerful magnet next to the magnetic switch.
- If the switch is properly closed but this message remains on the screen, either get the control board checked over or have it replaced.

- « iSbA » « or » « iSCU » « thEn » « iSbC » « And » « iSCO » message

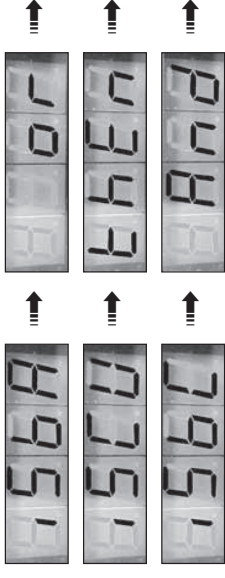

Either the tilt safety switch ("iSbA") or the magnetic bowl safety switch ("iSCU") is not being detected.

Checks to be made in the following order:

- 1) Check that the bowl has resumed its vertical position
- 2) Check that the bowl is properly locked at the right angle
- 3) Check (with an ohmmeter) that the contact of the tilt switch is closed and check the relevant wiring.
- 4) Check (with an ohmmeter) that the bowl presence switch's contact is closed. If necessary, remove the bowl and place a sufficiently powerful magnet close to the magnetic switch. Check the relevant wiring
- 5) If the tilt and bowl switches are both closed, carry out the checks described above for the "iSbC" and "iSCO" messages.

If all four tilt, bowl, lid arm and lid switches are closed but this message remains on the screen, either get the control board checked over or have it replaced.

- « Pto » « or » « rth » « or » « bPA » message

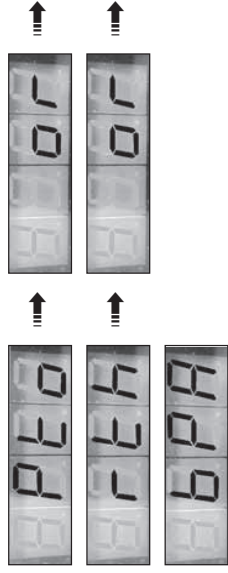

The motor's thermal protector ("Pto"), the thermal relay ("rth") contact or the "off" button ("bPA") contact is open.

Checks to be carried out in the following order

Situation n°1:

The message appears on the screen as soon as the machine is powered up.

- 1) Check that the thermal relay wire is correctly positioned to the right of the control board. See electrical diagram.
- 2) Check that the thermal relay has not been triggered and that it is adjusted to reset automatically.
- 3) Check (with an ohmmeter) that the thermal protector is closed. Check the relevant wiring.
- 4) Check (with an ohmmeter) that the thermal relay's contact is closed. Check the relevant wiring.

- 5) Check that the "off" button is not stuck in the open position. Move the button and listen out for the characteristic "click".

Situation n°2:

- The message appears when the motor is very hot (orange indicator light on).
The "off" button is open: wait ten or so minutes for the motor to cool down (the orange light will go out) before trying to start the machine up again.

- The machine has been subjected to very intensive use.

The thermal relay is open: wait a couple of minutes for the thermal relay to reset and reduce the load placed on the motor before trying to switch it back on.

Situation n°3:

The message appears even though the motor is not hot and the machine has not been subjected to intensive use:

- 1) Check that the "off" button is not stuck in the open position. Move the button and listen out for the characteristic "click".
- 2) Check (with an ohmmeter) that the thermal protector is closed. Check the relevant wiring.
- 3) Check (with an ohmmeter) that the contact of the thermal relay is closed. Check the relevant wiring.

If the message persists, even though the thermal protector and the thermal relay are closed, the "off" button is moving freely and the wiring is in accordance with the electrical diagram, either get the control board and timer board checked over or have them replaced.

- « RELEASE bP1 » message



The contact of the 1st speed "on" button ("bP1") remains closed.

Either release the button or check that it is not stuck. Move the button and listen out for the characteristic "click".

- If the 1st speed "on" button is working properly but the message remains on the screen, either get the control board checked over or have it replaced.

- « RELEASE bP2 » message



The contact of the 2nd speed "on" button ("bP2") remains closed.

Carry out the checks recommended for the 1st speed "on" button.

If the 2nd speed "on" button is working properly but the message remains on the screen, either get the control board checked over or have it replaced.

- « RELEASE bPP » message



The contact of the "pulse control" button ("bPP") remains closed.

Carry out the checks recommended for the 1st speed "on" button.

If the "pulse control" button is working properly but this message remains on the screen, either get the control board checked over or have it replaced

- « not u.u. » message



The control board is not correctly configured.

- Position the JP1, JP2 and JP3 jumpers according to the machine's electrical diagram.

- « FrEquEnCY » message

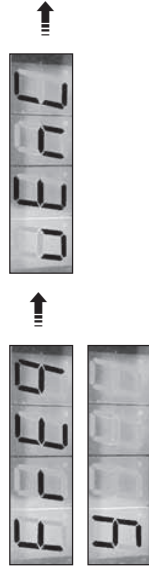

The control board cannot determine the frequency of the mains supply.

Unplug the machine and wait for 5 minutes before plugging it back in.

If this message remains on the screen, either get the control board checked over or have it replaced.

TECHNICAL SPECIFICATIONS

In order to obtain good results when mincing meat, grinding and kneading, we recommend you fill the bowl no more than half-full.

• BOWL CAPACITIES

- R 23 / Blixer® 23 : 24 quarts
- R 30 / Blixer® 30 : 29 quarts
- R 45 / Blixer® 45 : 47 quarts
- R 60 / Blixer® 60 : 63 quarts

• WEIGHT (lbs)

	Net	Gross
R 23/R 30	223	289
Blixer® 23/Blixer® 30 :		
R 45	305	364
Blixer® 45 :		
R 60	331	390
Blixer® 60 :		

• INSTALLATION

We recommend that you install your vertical cutter-mixer on a flat, stable surface.

• NOISE LEVEL

The equivalent continuous sound pressure level when running these appliances empty is less than 70 dB (A).

SAFETY

These appliances are fitted with four interlocking devices.

The machine can be started only if the following conditions are achieved:

- The bowl is locked in the right angular position,
- The bowl and the motor are in vertical position,
- The lid is locked on its support in the correct angular position,
- The lid is closed on the bowl.

Caution: Allow product circulation to stop before opening the lid.

These models are also fitted with a **thermal protection system** (with automatic reset) which stops the motor if it is overloaded. A red warning light signals that the machine is becoming too hot and is about to stop.

If this happens, wait until the appliance has cooled down before switching it back on (the orange light will switch off and the green lights will switch on again).

WARNING

The blades are extremely sharp.
Handle with care.

REMEMBER

Never try to override the locking and safety systems.

Never insert a nonfood into the container where the food is being processed.

Never push the ingredients down with your hand.
Do not overload the appliance.

SERVICE

See warranty first then;

Should your unit require service, check with your distributor to see where local service is available. If not or if you wish your unit to be serviced at the factory, call for return instructions and ship the unit prepaid to our factory address.

PH : 1-800-824-1646

Robot-Coupe USA, Inc

Service Department Repair

264 South Perkins Street





Ridgeland, MS 39157

For service in Canada contact the Robot-Coupe USA factory for repair instructions.

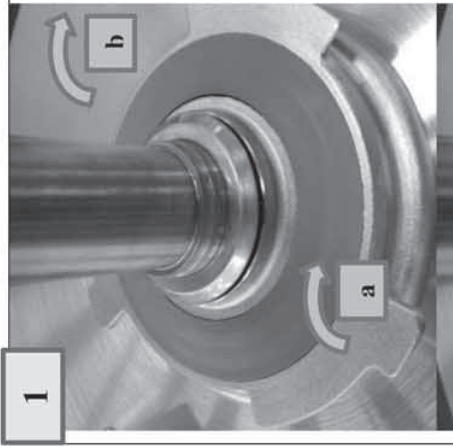
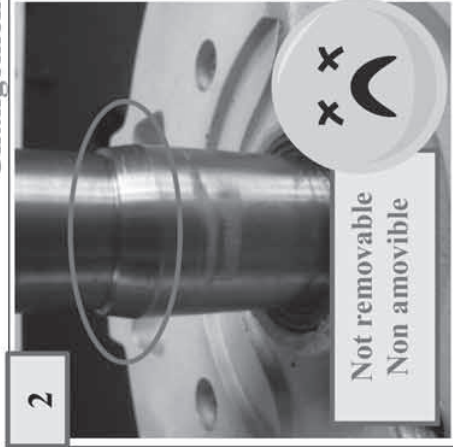
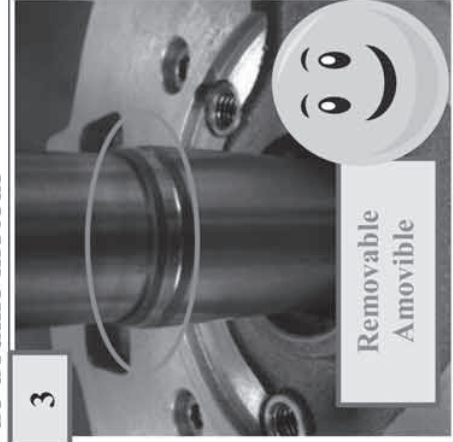

robot  **coupe**[®]

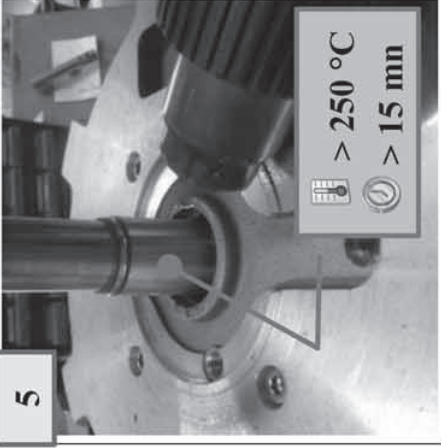
TECHNICAL DATA

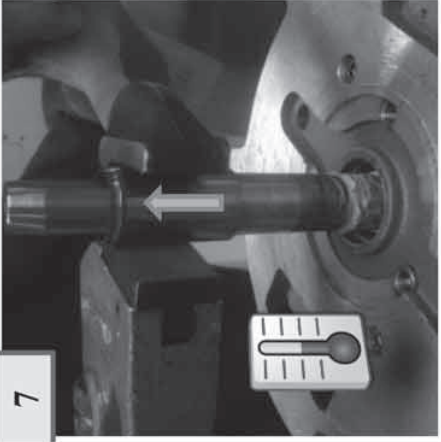
VCM – R23 – Blixer®60
Motor Sleeve Replacement
Changement de douille moteur

	 <p>Not removable Non amovible</p>	 <p>Removable Amovible</p>	
<p>Check point 2 or 3? If sleeve is removable then remove a) sealing socket and b) motor cover. Voir point 2 ou 3 ? Si la douille est amovible, retirer a) la douille porte joint et b) le capot moteur supérieur.</p>	<p>Old motors without any groove in the chamfer cannot be repaired. Please contact your sales representative. Les anciens moteurs sans gorge dans le chanfrein ne peuvent pas être réparés.</p>	<p>Only motor with a grooved chamfer can be repaired. Seuls les moteurs avec une gorge dans le chanfrein peuvent être réparés. Dans le cas contraire, merci de contacter votre revendeur.</p>	<p>You need an adjustable spanner, a plug spanner, a stripper or a blowlamp. Vous aurez besoin d'une clé à molette, d'une clé à griffe, d'un décapeur ou d'un chalumeau.</p>
			
<p>Remove lip seal. Heat the old sleeve: turn the motor shaft to get homogeneous temperature. Démonter le joint à lèvres. Chauffer la douille en tournant régulièrement l'arbre moteur pour que la chauffe soit homogène</p>	<p>Remove the old sleeve by turning the motor shaft alternatively and pull it upward. Extraire la douille en tournant l'axe alternativement et en tirant la douille vers le haut.</p>	<p>Continue to pull it upward till it is completely remove. Continuer jusqu'à extraction complète.</p>	<p>Burned glue residues on sleeve area must be removed. Des restes de colle brûlée sont présents sur la zone de la douille.</p>

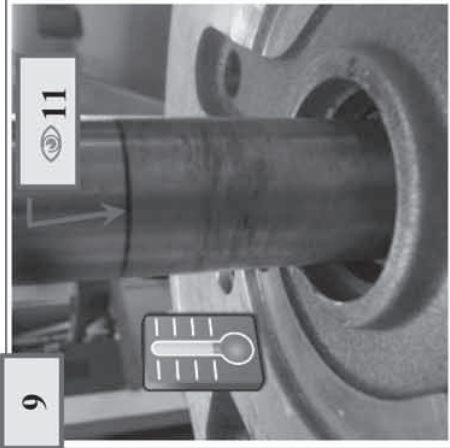
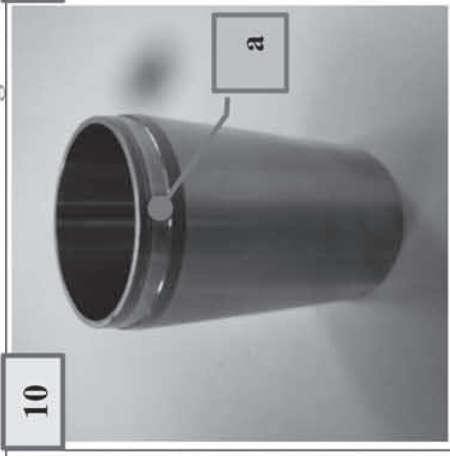
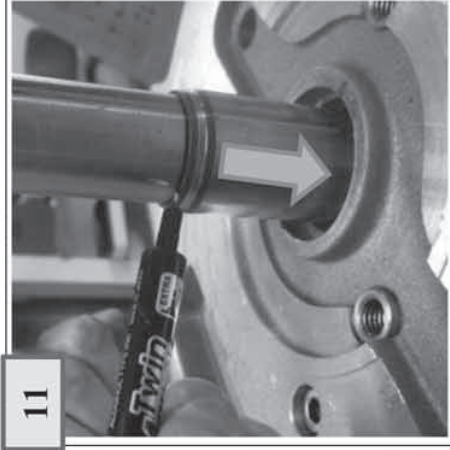
VCM – R23 – Blixer®60
Motor Sleeve Replacement
Changement de douille moteur

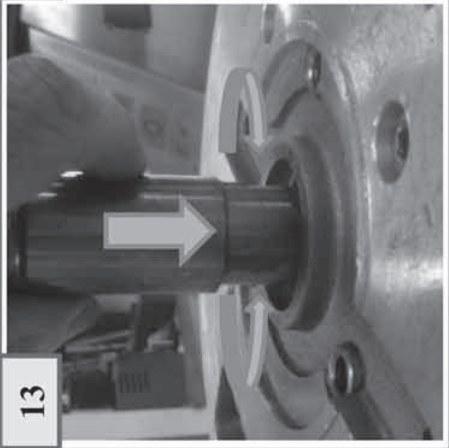
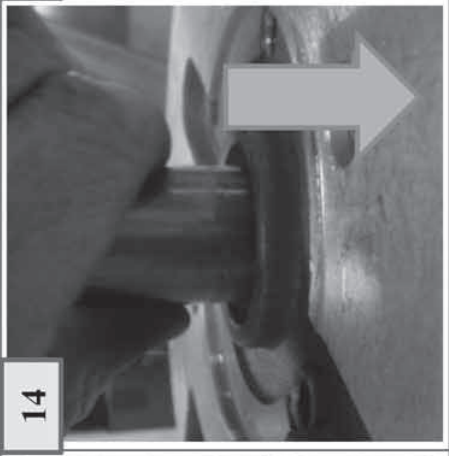
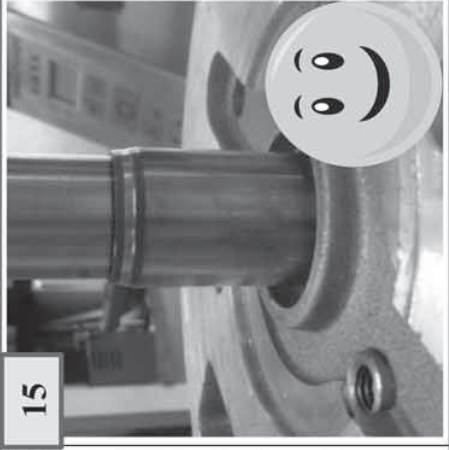
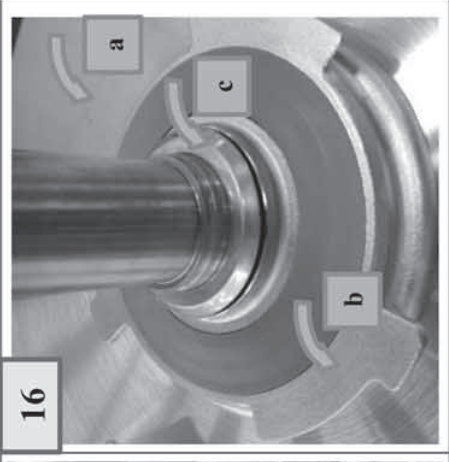
<p>9</p> 	<p>Once the motor shaft is cleaned, check that the sleeve could be easily placed and touch the shoulder. Quand l'arbre est nettoyé, vérifier que la douille se monte facilement jusqu'à l'appui.</p>
<p>10</p> 	<p>Replacement sleeve is supplied with glue and get a groove (a) to identify the upper side. La douille de remplacement est fournie avec la colle et comporte une gorge de repérage (a) qui indique le haut de la pièce.</p>
<p>11</p> 	<p>The next step could be made easier by marking upper glue limit (see note 11 step 9). La limite haute de la zone de collage peut être tracée afin de faciliter l'étape suivante.</p>
<p>12</p> 	<p>Glue the motor shaft using the drawn line. Be careful, the glue could be liquid. Encoller l'arbre moteur en utilisant la ligne tracée comme repère supérieur. Attention, la colle peut être liquide.</p>
<p>13</p> 	<p>Place the new sleeve using alternative movements to completely glue both parts. Monter la douille en produisant des mouvements alternatifs afin d'encoller les 2 pièces.</p>
<p>14</p> 	<p>Check that the sleeve is well placed against the lower shaft shoulder (completely down). Contrôler que la douille est bien en appui sur l'épaule de l'arbre moteur (descendue à fond).</p>
<p>15</p> 	<p>Ready for new hours of work. Prêt pour de nouvelles heures de fonctionnement.</p>
<p>16</p> 	<p>Place new lip seal and deflector, a) secure motor cover, b) sealing socket then c) place a new shaft seal. Remonter les joints, a) le capot, b) la douille porte joint puis c) un nouveau joint facial.</p>

R 23 A - BLIXER 23 A - R 30 A - BLIXER 30 A R 45 A - BLIXER 45 A - R 60 A - BLIXER 60 A

200V/50Hz - 200V/60Hz 3~
220V/60Hz - 230V/50Hz 3~
380V/60Hz - 400V/50Hz 3~ - 440V/60Hz 3~

SCHEMA ELECTRIQUE

ELECTRIC DIAGRAM

ELEKTRISCHES SCHALTBIELD

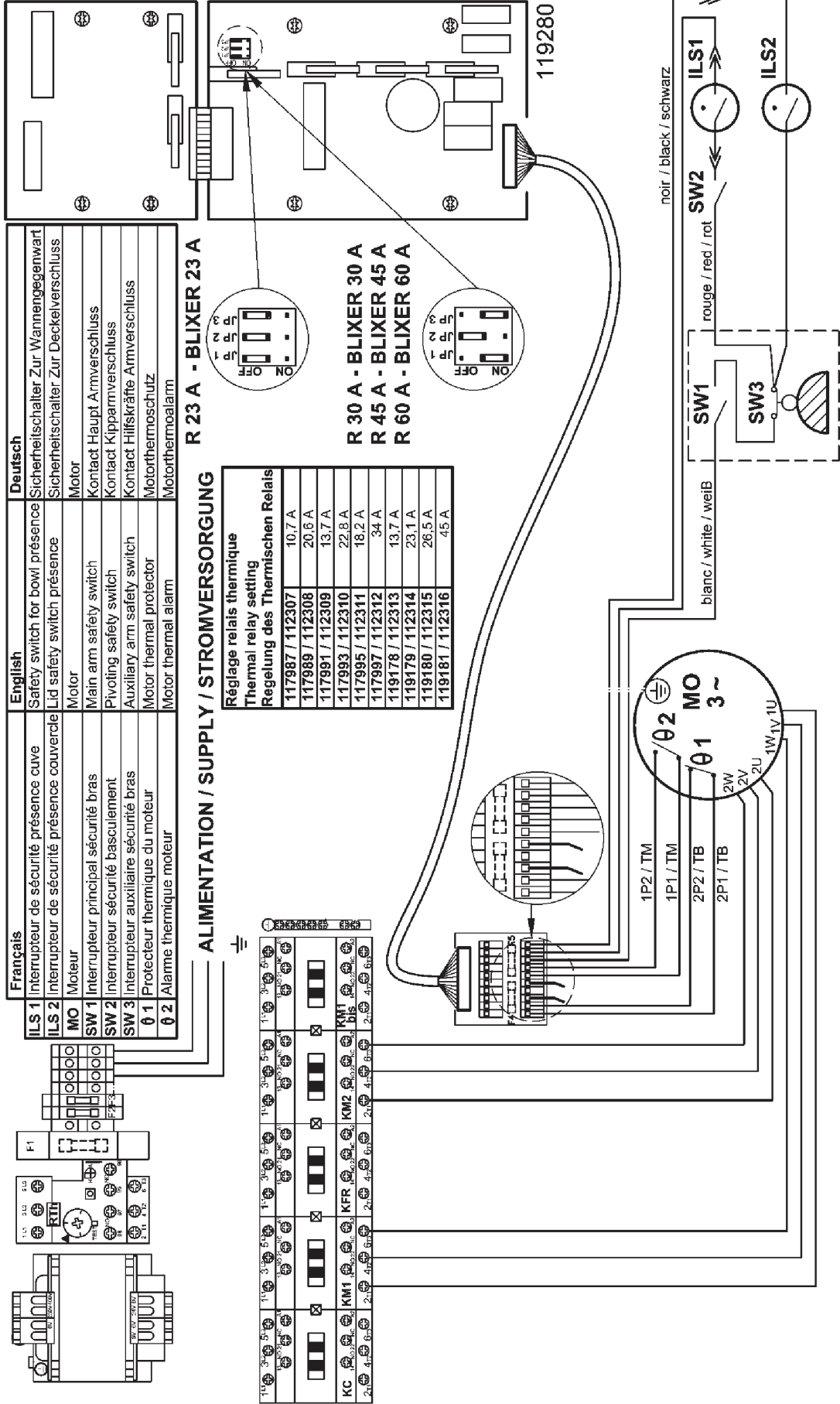

R 23 A - BLIXER 23 A

380V/60Hz-3~
400V/50Hz-3~
440V/60Hz-3~

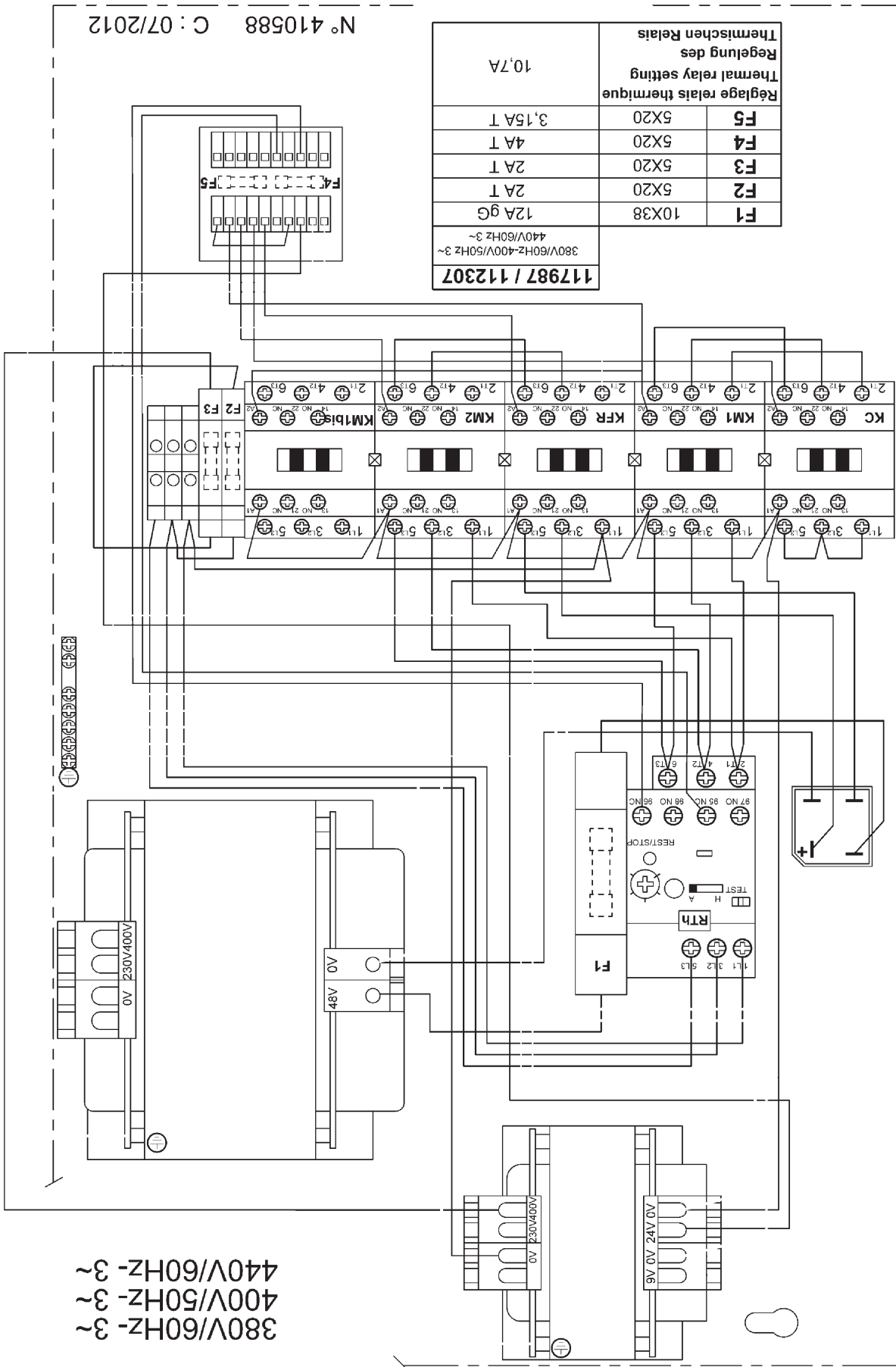

R 30 A - BLIXER 30 A

380V/60Hz-400V/50Hz 3~
440V/60Hz 3~

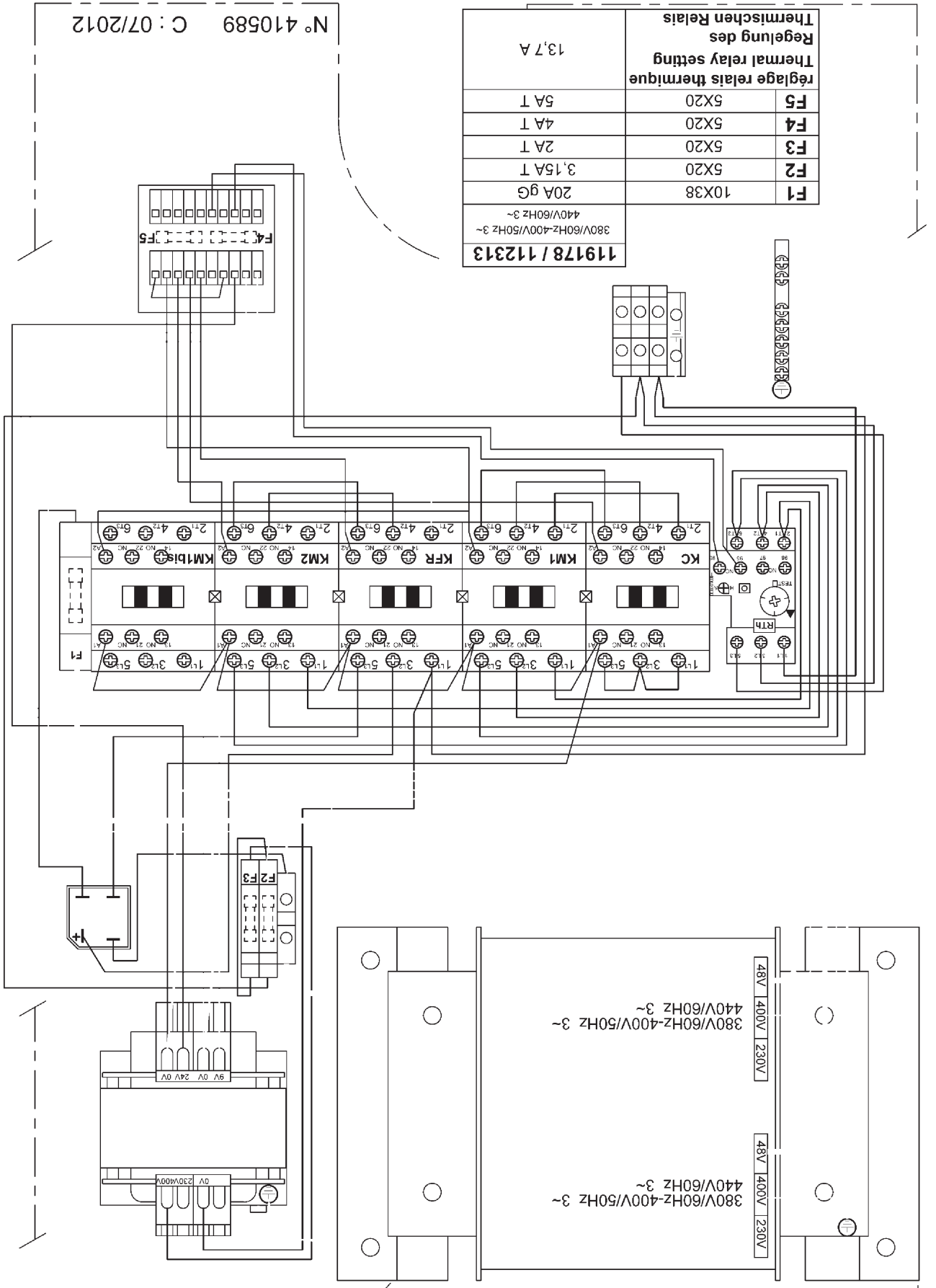

380V/60HZ-400V/50HZ 3~
440V/60HZ 3~

R 45 A - BLIXER 45 A
R 60 A - BLIXER 60 A

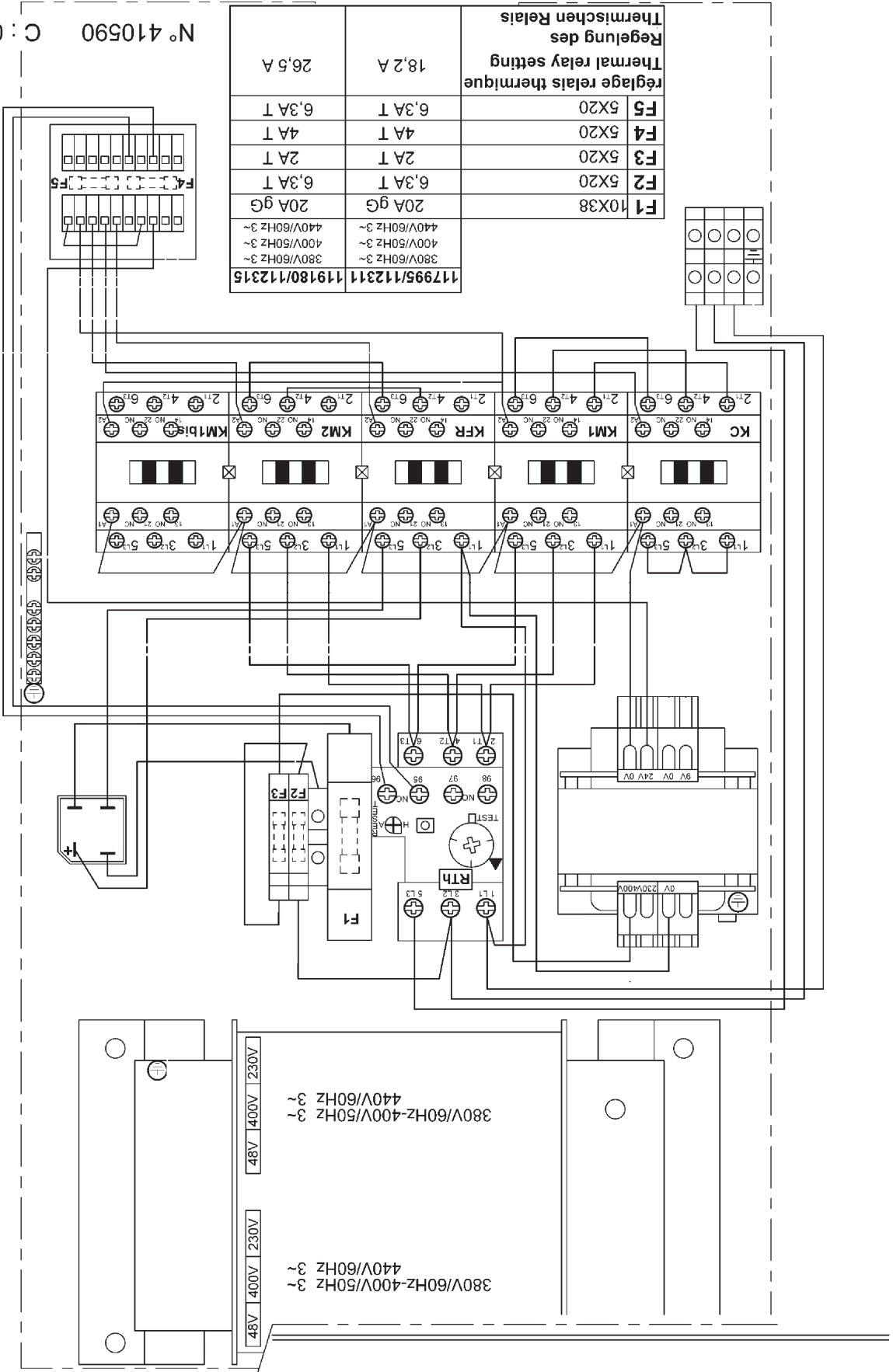

réglage relais thermique Thermal relay setting Thermischen Relais	
F1 10X38	20A gG
F2 5X20	6,3A T
F3 5X20	2A T
F4 5X20	4A T
F5 5X20	6,3A T
117995/12311	380V/60Hz 3~
119180/12315	400V/50Hz 3~
	440V/60Hz 3~
	20A gG
	6,3A T
	2A T
	4A T
	6,3A T
	18,2 A
	26,5 A

N° 410590 C : 07/2012

R 23 A - BLIXER 23 A

200V/50Hz 3~
 200V/60Hz 3~
 220V/60Hz 3~
 230V/50Hz 3~

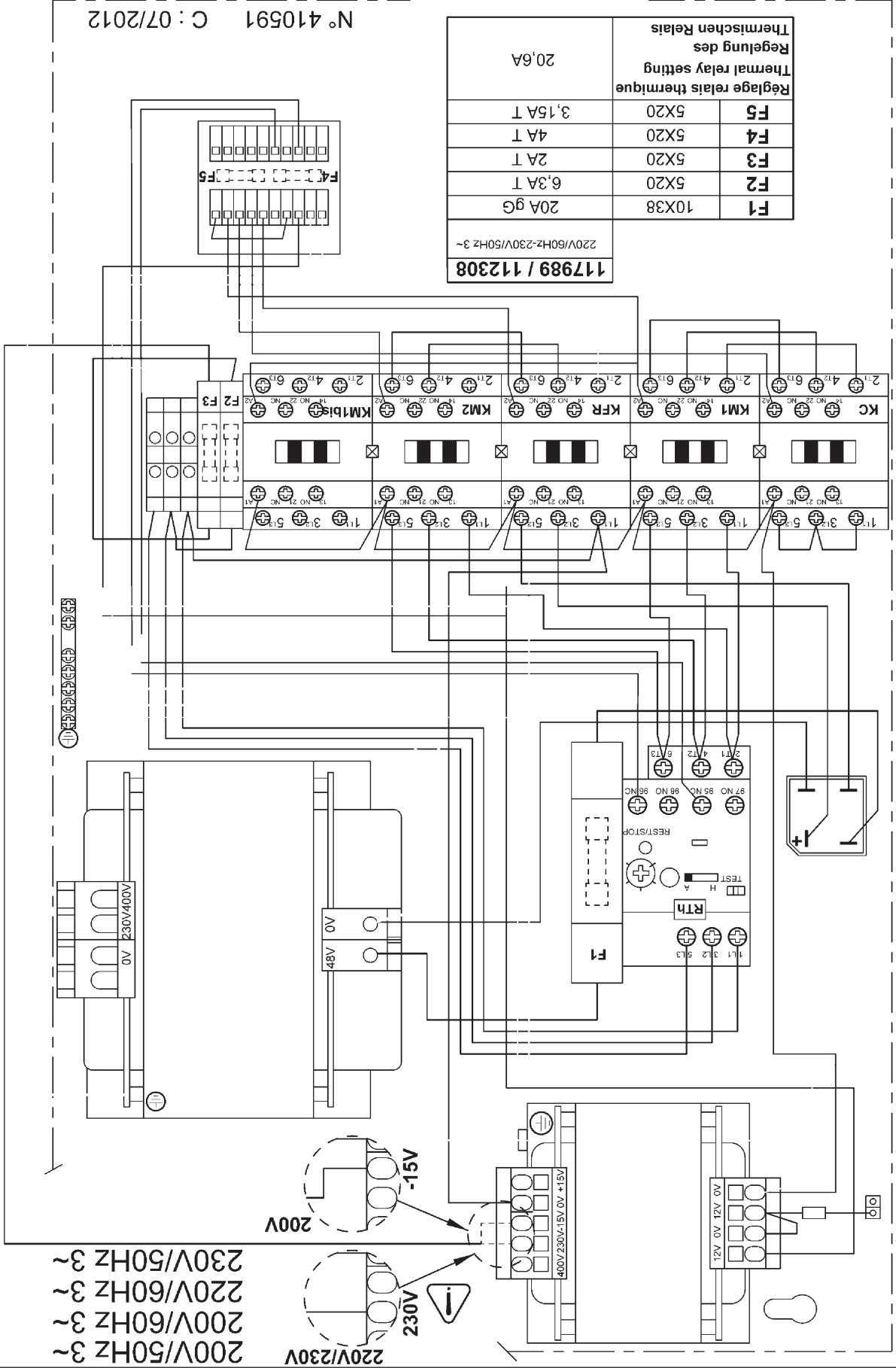

Thermischen Relais		20,6A
Regelung des Thermal relay setting	220V/60Hz-230V/50Hz 3~	
Réglage relais thermique	117989 / 112308	
F1	10X38	20A gG
F2	5X20	6,3A T
F3	5X20	2A T
F4	5X20	4A T
F5	5X20	3,15A T

N° 410591 C : 07/2012

R 30 A - BLIXER 30 A

200V/50Hz-200V/60Hz 3~
220V/60Hz-230V/50Hz 3~

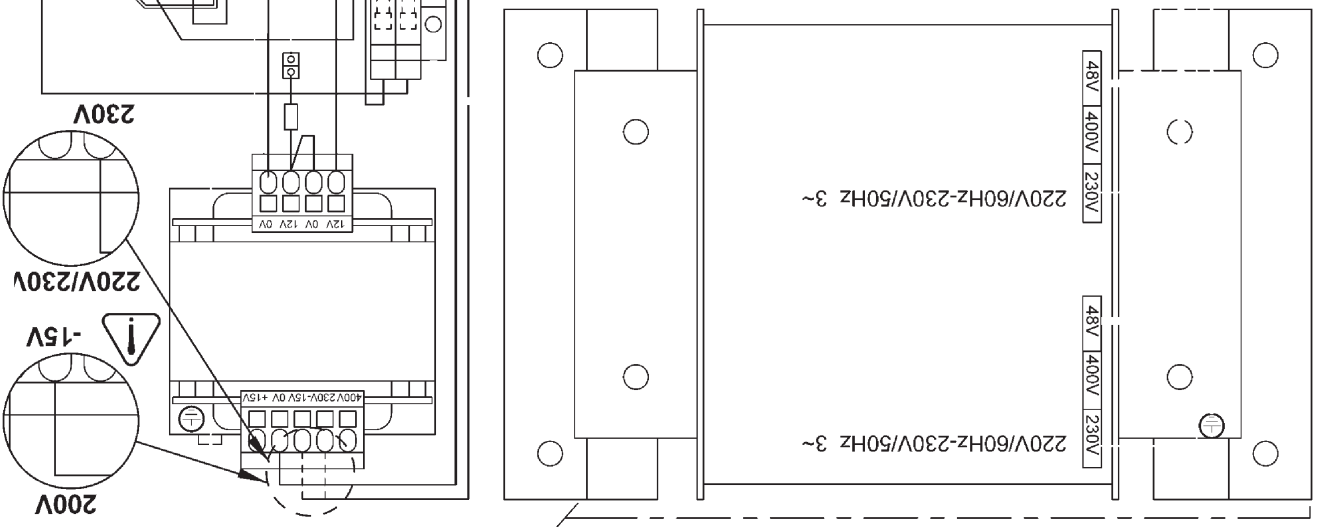

Thermischen Relais	
Régulation des Thermal relay setting	
réglage relais thermique	
F5	5X20
F4	4A T
F3	2A T
F2	5X20
F1	10X38
10A AM	
220V/60Hz-230V/50Hz 3~	
119179 / 112314	

N° 410592 C : 07/2012

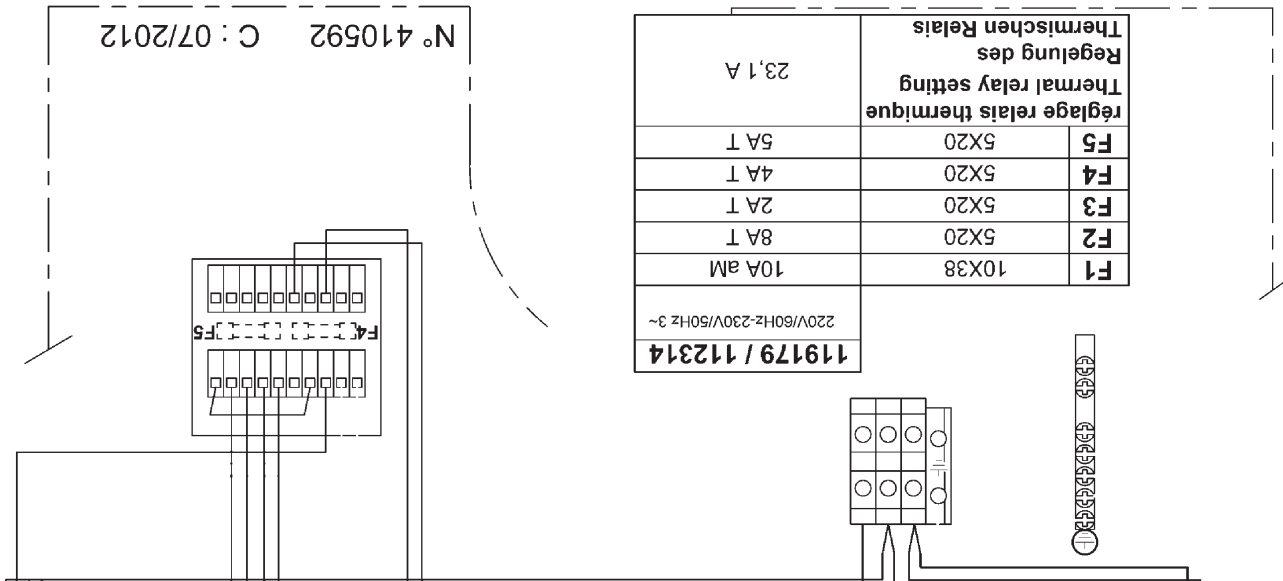



robot coupe[®]

Robot Coupe U.S.A., Inc.,

Phone: 800/824-1646 • 601/898-8411

264 South Perkins St., Ridgeland, MS 39157

e-mail: info@robotcoupeusa.com

website: www.robot-coupe.com