

robot coupe[®]

New
Register
your product
on line



R 8 • R 10
R 15 • R 20

Blixer[®] 8 • Blixer[®] 10
Blixer[®] 15 • Blixer[®] 20

Robot-Coupe U.S.A., Inc.,

264 South Perkins, Ridgeland, MS 39157 - Phone : 800/824-1646 - 601/898-8411
email: info@robotcoupeusa.com - website: www.robot-coupe.com

TRANSLATION OF ORIGINAL INSTRUCTIONS

IMPORTANT WARNING



WARNING

KEEP THESE INSTRUCTIONS IN A SAFE PLACE

WARNING: In order to limit accidents such as electric shocks or personal injury, and in order to limit material damage due to misuse of the appliance, please read these instructions carefully and follow them strictly. Reading the operating instructions will help you get to know your appliance and enable you to use the equipment correctly. Please read these instructions in their entirety and make sure that anyone else who may use the appliance also reads them beforehand. Our equipment is designed for professional use and must not be used by children under any circumstances.

UNPACKING

- Carefully remove the equipment from the packaging and take out all the boxes or packets containing attachments or specific items.
- **WARNING:** some of the tools are very sharp e.g. blades, discs... etc..
- Store manuals, tools and spare parts in a safe place available to the users of the machine

INSTALLATION

- This machine must be operated on a clean sturdy counter or table. Keep the area around and under the machine clear to allow air circulation. Otherwise the motor can overheat. All four feet must be in place.

CONNECTION

- Always check that your power supply corresponds to that indicated on the identification plate on the motor unit and that it can withstand the amperage.
- The unit must always be connected to a grounded outlet with Ground Fault Circuit Interrupter (GFCI) protection device.
- Always check that the motor shaft rotates in counter clockwise direction before the blades are installed.

HANDLING

- Always take care when handling the blades, as they are extremely sharp.
- Wear cut-proof gloves when handling the blades.

USE

- The machine must not be modified in any way from its original configuration.
- Never tamper with, or defeat the purpose of the locking and safety systems.
- Do not put nonfood objects in the bowl.
- Do not leave the machine running unattended.
- The machine must be operated and stored in a location not subject to water drips or spray or explosive vapors.
- Should the machine malfunction or should any part be damaged, it must not be operated until it is repaired by a qualified technician using only genuine Robot Coupe repair parts.

- Failure to follow these operating instructions or attempts to operate the machine outside its design limits may create a hazardous condition that could damage the machine and/or injure users. Special attention should be given to the use of the operation controls and safety features.

- The unit is equipped with a thermal overload circuit-breaker. If the unit overheats due to an overload condition, it will automatically shut off. After cooling a few minutes the thermal overload circuit-breaker may be reset. Press the reset button located on the bottom left front of the unit.

- Operating times of 5 minutes or longer can cause processed food to increase to temperatures above 125° F (52° C).
- Maximum fill level is $\frac{2}{3}$ full, less if the product is very dense or sticky.

CLEANING

- As a precaution, always unplug your appliance before cleaning it.
- Always clean the appliance and its attachments at the end of each cycle.
- Never immerse the motor base in water.
- For parts made from aluminum, use metal safe detergents intended for aluminum.
- Caustic detergents used in automatic dishwashers quickly degrade plastic parts. Hand wash plastic parts if possible.
- Robot Coupe can in no way be held responsible for the user's failure to follow the basic rules of cleaning and hygiene.

MAINTENANCE

- Do not open the motor housing. There are no user serviceable components inside the electrical housing. Refer control component repairs to qualified technicians.
- Replace seals every 3 to 6 months. Lubricate with food safe grease.
- It is particularly important to maintain and check the attachments since certain ingredients contain corrosive agents, e.g. citric acid.
- Never operate the appliance if the power cord or plug has been damaged or if the appliance fails to work properly or has been damaged in any way.
- If the machine malfunctions in any way discard any food being processed and refer service to qualified maintenance technicians.

@ www.robotcoupeusa.com

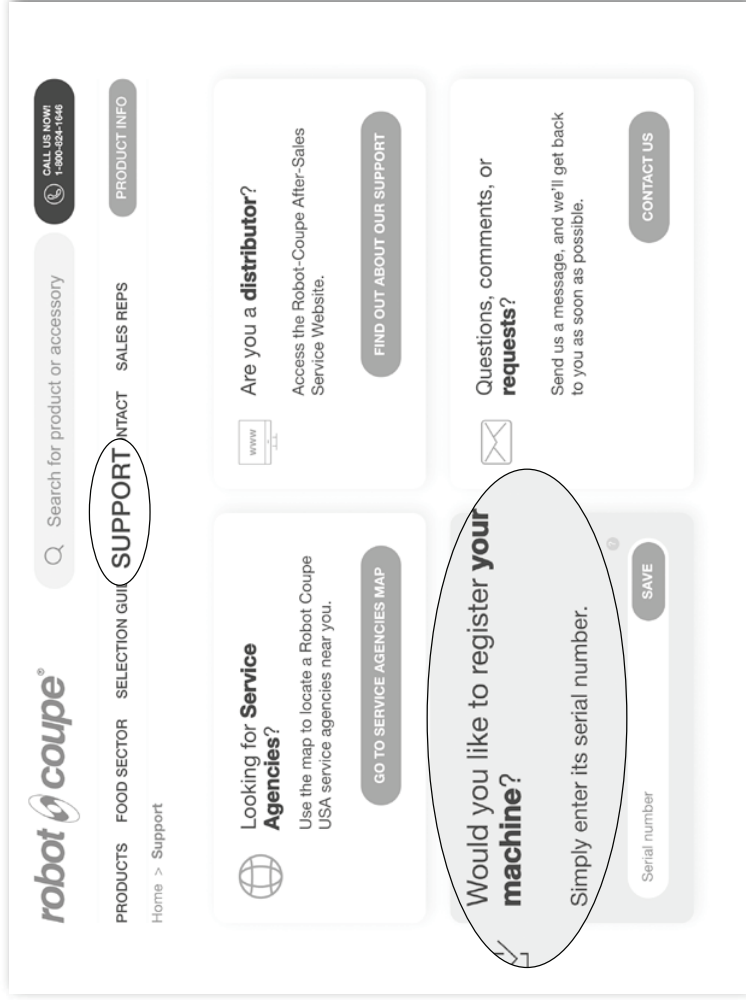

Register your product online

We reserve the right to alter at any time without notice the technical specifications of this appliance.
None of the information contained in this document is of a contractual nature. Modifications may be made at any time.
© All rights reserved for all countries by: ROBOT-COUPÉ S.N.C.

CONTENTS

WARRANTY

IMPORTANT WARNING

INTRODUCTION TO YOUR NEW BLIXER® OR A CUTTER MIXER R 8 • R 10 • R 15 • R 20 • Blixer® 8 • Blixer® 10 • Blixer® 15 • Blixer® 20

SWITCHING ON THE MACHINE

- Advice on electrical connections
- Control panel

ASSEMBLY

- Machine
- Blade (Cutter only)

USES AND EXAMPLES

OPTIONS (Cutter only)

- Stainless-steel mini bowl
- Serrated knife - Fine serrated knife
- Vacuum kit R-Vac®

HYGIENE

CLEANING

- Bowl
- Blade
- Scraper arm (Blixer® only)

MAINTENANCE

- Dismantling the blade assembly
- Mini bowl blade (Cutter only)
- Scraper arm (Blixer® only)
- Blades
- Seal
- Lid seal

DIAGNOSTIC SYSTEM

OPERATING INSTRUCTIONS FOR THE VACUUM KIT R-VAC® (Cutter only)

FITTING AND USING THE BLADE ASSEMBLY

TECHNICAL SPECIFICATIONS

- Weight & Dimensions
- Working space
- Noise level
- Electrical data

SAFETY

SERVICE

ELECTRICAL AND WIRING DIAGRAMS

ROBOT COUPE U.S.A., INC. ONE YEAR LIMITED COMMERCIAL WARRANTY

YOUR NEW ROBOT-COUPE COMMERCIAL PRODUCT IS WARRANTED TO THE ORIGINAL PURCHASER FOR A PERIOD OF ONE YEAR FROM THE DATE OF PURCHASE.

This LIMITED COMMERCIAL WARRANTY is against defects in the material and / or workmanship, and includes labor for replacement of defective parts, provided repairs are performed by an authorized service agency (see attached list). The CUSTOMER must inform the Service Agency of the possibility of warranty coverage and provide a copy of the dated sales or delivery receipt BEFORE WARRANTY REPAIRS ARE BEGUN. All parts or accessories replaced under warranty must be returned to the Service Agency. The warranty for work done or parts replaced under warranty expires at the end of the original warranty period.

Replacement parts and accessories are warranted for ninety (90) days from the date of purchase when purchased separately and will be verified by dated sales receipt OR packing slip which list that item.

All Robot-Coupe Products are considered commercial use only.

THE FOLLOWING ARE NOT COVERED UNDER WARRANTY:

- 1 - Damage caused by abuse, misuse, dropping, or other similar incidental damage caused by or as result of failure to follow installation, assembly, operating, cleaning, user maintenance or storage instructions, including failure to verify and correct rotation of three phase motors.
- 2 - Labor to sharpen and/or parts to replace knife assemblies or blades which have become dull, chipped, or worn due to normal use.
- 3 - Material or labor to renew or repair scratched, stained, chipped, dented, or discolored surfaces, blades, knives, attachments, or accessories.
- 4 - Transportation charges to or from an authorized service agency for repairs of a machine designated as "CARRY IN SERVICE" (Table Top Models).
- 5 - Labor charges to install or test attachments or accessories (i.e. bowls, cutting plates, blades, attachments) which are replaced for any reason.
- 6 - Charges to change Direction-of-Rotation of Three Phase electric motors (INSTALLER IS RESPONSIBLE). All Robot Coupe products must operate counter-clock-wise.
- 7 - SHIPPING DAMAGE IS NOT COVERED BY WARRANTY. Visible and hidden damages are the responsibility of the freight carrier. The consignee must file a damage claim promptly against the carrier, or upon discovery in the case of hidden damage.
- 8 - Any ROBOT-COUPE COMMERCIAL PRODUCT used in an Industrial application.

Commercial equipment use is defined as but not limited to the preparation of food substance within the confines of a restaurant/facility, that is sold and consumed within said restaurant/facility.

Industrial equipment use is defined as but not limited to the manufacturing of food substance in large batch quantities. The processed food is then packaged and sold off site and or to a distributor for resale off site.

KEEP ALL ORIGINAL CONTAINERS AND PACKING MATERIALS FOR CARRIER INSPECTION

All Robot-Coupe equipment should be operated in an ambient room temperature of 60 degrees (F) or higher.

Robot-Coupe U.S.A., Inc., Robot-Coupe S.A., or any of their affiliates, distributors, officers, directors, agents, employees or insurers will not be obligated for consequential or other damages, losses, or expenses in connection with or by reason of the use of or the inability to use the machine for any purpose.

THIS WARRANTY IS GIVEN EXPRESSLY AND IN LIEU OF ALL OTHER WARRANTIES EXPRESSED OR IMPLIED, FOR MERCHANTABILITY AND FOR FITNESS TOWARD A PARTICULAR PURPOSE AND CONSTITUTES THE ONLY WARRANTY MADE BY ROBOT-COUPE, U.S.A., Inc.

IMPORTANT WARNING



WARNING

KEEP THESE INSTRUCTIONS IN A SAFE PLACE

WARNING: In order to limit accidents such as electric shocks or personal injury, and in order to limit material damage due to misuse of the appliance, please read these instructions carefully and follow them strictly. Reading the operating instructions will help you get to know your appliance and enable you to use the equipment correctly. Please read these instructions in their entirety and make sure that anyone else who may use the appliance also reads them beforehand. Our equipment is designed for professional use and must not be used by children under any circumstances.

UNPACKING

- Carefully remove the equipment from the packaging and take out all the boxes or packets containing attachments or specific items.
- **WARNING** - some of the tools are very sharp e.g. blades, discs... etc.
- Store manuals, tools and spare parts in a safe place available to the users of the machine.

INSTALLATION

- Install the machine on a clear floor space with sufficient room to safely operate and clean the machine.

CONNECTION

- Always check that your power supply corresponds to that indicated on the identification plate on the motor unit and that it can withstand the amperage.
- The machine must be grounded.
- Always check that the motor shaft rotates in anticlockwise direction before the blades are installed.

HANDLING

- Always take care when handling the blades, as they are extremely sharp.
- Wear cut-proof gloves when handling the blades.

ASSEMBLY PROCEDURES

- Follow the various assembly procedures carefully (see page 6) and make sure that all the attachments are correctly positioned.

USE

- Never try to override the locking and safety systems.
- Never insert any object into the container where the food is being processed.
- Never push the ingredients down with your hand.
- Do not overload the appliance.

- Maximum fill level is $\frac{2}{3}$ full, less if the product is very dense or sticky.

CLEANING

- As a precaution, always unplug your appliance before cleaning it.
- Always clean the appliance and its attachments at the end of each cycle.
- Never immerse the motor unit in water.
- For parts made from aluminum, use metal safe detergents intended for aluminum.

- Caustic detergents used in automatic dishwashers quickly degrade plastic parts. Hand wash plastic parts if possible.
- Robot-Coupe can in no way be held responsible for the user's failure to follow the basic rules of cleaning and hygiene.

MAINTENANCE

- Do not open the motor housing. There are no user serviceable components inside the electrical housing. Refer control component repairs to qualified technicians.
- Remove and clean shaft seals monthly. Replace seals each 3 to 6 months. Lubricate with food safe grease.
- It is particularly important to maintain and check the attachments since certain ingredients contain corrosive agents, e.g. citric acid.
- Never operate the appliance if the power cord or plug has been damaged or if the appliance fails to work properly or has been damaged in any way.
- If the machine malfunctions in any way discard any food being processed and refer service to qualified maintenance technicians.

INTRODUCTION TO YOUR

NEW BLIXER® OR A CUTTER MIXER R 8 • R 10 • R 15 • R 20 Blixer® 8 • Blixer® 10 • Blixer® 15 • Blixer® 20

Its simple design means that all parts which are handled frequently can be easily assembled, or removed for maintenance or cleaning.

To make things easier for you, this instructions manual has been divided according to the various assembly operations.

To make things easier for you, this instructions manual has been divided according to the various assembly operations.

This manual contains vital information designed to help the user get the most out of his or her cutter mixer.

Consequently, we strongly advise you to read the manual carefully before using your machine.

We have also included a few examples to help you get the feel of your new machine and appreciate its countless advantages.

SWITCHING ON THE MACHINE



WARNING

This appliance must be plugged into an grounded socket (risk of electrocution).

• ADVICE ON ELECTRICAL CONNECTION

Before plugging in, check that your power supply corresponds to that indicated on the machine rating plate.

**Three phase R 8 • R 10 • R 15 • R 20
Blixer® 8 • Blixer® 10 • Blixer® 15 • Blixer® 20**

These models must be powered from a 220 V / 60 Hz / 3 phase electrical supply.

The machine is supplied with a power cord and a plug attachment. If wiring to a service disconnect box, this should be undertaken by a qualified electrician.

The power cord has four wires, one grounded wire, plus three phase wires.

Connect the green wire to the ground terminal pin.

These machines do not require a neutral connection.

• CONTROL PANEL

R 8 • R 10 • R 15 • R 20

Blixer® 8 • Blixer® 10 • Blixer® 15 • Blixer® 20:

Red button  = "Off"

Green button I  = "On" Low speed

Green button II  = "On" High speed

Black button  = Pulse control

Green indicator  = Machine status indicator

ASSEMBLY

• MACHINE



1. With the motor base facing you, position the bowl on the motor shaft so that the handle on your left is near the control panel.

2. Pressing down on the handles, turn the bowl firmly in an anticlockwise direction until it locks into place.



3. Position the blade mounted on the motor shaft. Then rotate it so that it is lowered right down to the bottom of the bowl.

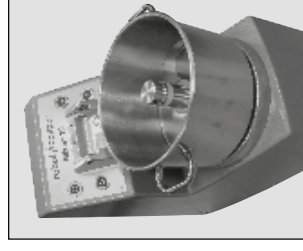

Always check that the blade is correctly positioned at the **bottom of the bowl** before adding the ingredients to be processed.

- If the lid parts are already assembled:

4. Place the lid assembly in the correction position.

Next, insert the metal pin as far as it will go.

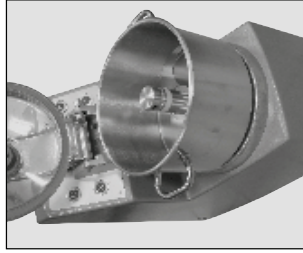

- If the lid parts have not been assembled:

4. Position the end of the lid arm in the hinge. Next, insert the metal pin as far as it will go (photo 1).

Push the lid guide through the lid arm hole and screw the cone into the top of the guide (photo 2).

Clip the lid onto the guide and turn it so that the dimples are beneath the lid arm (photo 3).

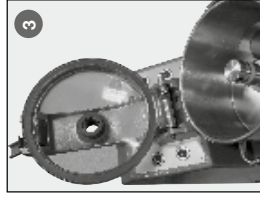
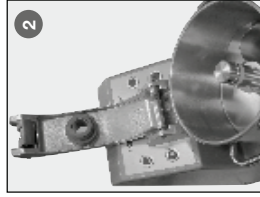
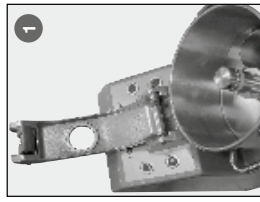

5. Close the lid by securing the locking hook to the edge of the bowl and pushing the handle down.

The machine is now ready for operation.

The green indicator light should be on.

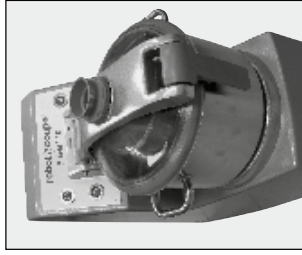

WARNING

There is a green safety indicator light on the control panel of the motor unit. If this green light does not come on, consult the relevant paragraph. A flashing green light means that the conditions for the safe operation of the machine have not all been met. Check that the bowl, lid arm and lid are all correctly positioned. As soon as the light stops flashing and stays on, you can use your machine.

• BLADE

(Cutter only - see diagram, page 14)

The blades are actually wearing parts, which should be replaced as a complete set once a year or as needed, to ensure consist quality in the final product.

For fine stuffing, mousse and emulsions, use the smooth blades.

There should not be any rings between the base of the blade holder and the lower blade.

You must always insert the small ring between the blade holder base and the lower blade (bowl base assembly) before carrying out mincing tasks. In order to control the mincing process and prevent the meat from overheating, always use the «pulse» switch (coarse mincing assembly).

For grinding or kneading, use serrated blades and do not fit any rings between the lower blade and the base of the blade shaft.

Use fine serrated blades to chop parsley and do not insert any rings between the blade holder base and the lower blade.

USES & EXAMPLES

• CUTTER

USES	Max processing quantity (in pounds)				Speed
	R 8	R 10	R 15	R 20	
CHOP					
• MEAT					
Hamburger/ steak tartare	6 5/8	8 3/4	13 3/16	17 7/8	Low
Sausage meat / tomatoes	6 5/8	8 3/4	13 3/16	17 7/8	Low
Terrine / pâté	4 3/8	8 3/4	17 5/8	22	Low
White pudding / liver mousse	8 3/4	11	19 7/8	24 1/4	High
Calantine (stuffing + thin slices)	4 3/8	6 5/8	17 5/8	22	High
• FISH					
Brandade / quenelle	8 3/4	11	15 7/16	19 7/8	High
Terrines	8 3/4	11	19 7/8	24 1/4	High
• VEGETABLES					
Carrot / parsley / onion / shallots	2 1/4 to 6 5/8	2 1/4 to 6 5/8	4 3/8 to 11	4 3/8 to 13 3/16	High
Soup / vegetable purées	8 3/4	11	19 7/8	24 1/4	Low
• FRUIT					
Compotes / fruit purée	8 3/4	11	19 7/8	24 1/4	Low
EMULSIFY					
Mayonnaise / aioli	8 3/4	11	19 7/8	24 1/4	High
Rémoullade sauce	8 3/4	11	19 7/8	24 1/4	Low
Snail / salmon butter	4 3/8	6 5/8	11	15 7/16	Low
KNEAD					
Shortcrust pastry / shortbread	8 3/4	11	15 7/16	19 7/8	High
Flaky pastry	8 3/4	11	15 7/16	19 7/8	Low
Broche + Raisin dough	8 3/4	11	15 7/16	19 7/8	Low
GRIND					
Almond paste / nuts	4 3/8	6 5/8	11	13 3/16	Low
Seafood / ice cubes	4 3/8	6 5/8	13 3/16	17 5/8	Low
Breadcrumbs	4 3/8	6 5/8	11	13 3/16	Low

The cutter-mixer has numerous other applications. The above examples are given for guidance and may vary according to the quality of ingredients or recipes.

OPERATION

Because of the special bowl and blade design of the Robot Coupe Vertical Cutter Mixers, most operations are completed in a matter of seconds. The operator should pay close attention to the product as well as the amount of time required to process. Operations should be run on Low speed, using High speed only when an extremely fine puree consistency is desired.

There are two ways to run your unit. First of all, you may run the unit continuously by filling the bowl with food and simply letting it run until the desired consistency has been reached. Use this method to grind, mix, blend, puree, or emulsify. Secondly, you may chop with your unit by pulsing the machine.

Cut round products into halves or quarters and prep long vegetables into 3 to 4 inch pieces. Place these into the bowl, and using Low speed, pulse the unit on and off quickly. Usually 4 to 5 pulses yields an evenly mixed chopped substance.

TO CHOP

To achieve a chopped consistency for vegetables, cheese, meats, etc. fill the bowl with the product no more than $\frac{3}{4}$ full, or as low as two to three onions. Small batches would require lowering the top cutting blade. With the lid secured, and the speed selector in Low speed, press the pulse function quickly then release. Repeat this pulsing action, allowing the blade to stop each time, until the desired cut is achieved.

TO PUREE OR MIX

Fill the bowl with the product no more than $\frac{3}{4}$ full. Start the machine in Low speed and allow to run until the product is completely reduced. If necessary, turn the machine off and select High speed to finish the

product. It may be necessary to add some liquids to a puree to achieve the desired consistency. If a complete homogeneous mixture is required for analytical testing, it may be required to scrape the walls of the bowl one time during processing to complete the homogeneous mixture.

DOUGHS AND PASTRIES

Prepare doughs and pastries on Low speed only. In many cases it may be helpful to first mix all dry products then add the liquids. The unit should be run continuously until the product is completely processed. For thick doughs, such as for pizza, the machine will form a ball of dough when the mixing is complete. When a bowl is formed the machine should be turned off immediately to prevent over processing. Preparation times and all ingredients should be noted for different recipes.

As an example: detailed process for bread dough

- The blade assembly must be set-up with two blades only.
- Do not use the lid wiper / bowl scraper.
- Mix all ingredients except water and salt for 15 seconds on low speed,
- Stop the unit, open the lid and add water and salt (needs about 20 seconds),
- Knead for 35 seconds on low speed*. Stop immediately the machine when the ball is formed to avoid any overheating of the dough.

* Approximate duration: to set according to your own recipe.

• BLIXER®

HOSPITAL USES
SPOON FEEDING <ul style="list-style-type: none">• Minced foods: meat, fish etc...• Vegetables purees• Mousses: vegetables, fish etc...• Compotes of stewed fruit
SEMI-LIQUID FEEDING <p>This simply entails diluting spoon-feeding preparations:</p> <ul style="list-style-type: none">• Minced meat + gravy• Puree + liquid (broth, milk, etc.)• Soups / creamed soups• Fruit compotes + syrup or water
LIQUID FEEDING (for use via tubes) <ul style="list-style-type: none">• Soups and any preparations that can be liquidized.
DELICATESSEN USES
<ul style="list-style-type: none">• Butter mixtures: snail butter, salmon butter, anchovie butter...• Sauces: green sauce, mayonnaise, remoulade, ailoli, emulsified sauces with tomatoes, cream, parsley...• Vegetable mousses.• Grinding: lobster, scampi, seashells...
PHARMACEUTICAL AND CHEMICAL LABORATORY USES
<ul style="list-style-type: none">• Grinding: herbs, seeds, powders, tablets....• Mixing: homogenization of creams, ointments, mixed components, varied ingredients...

OPTIONS (Cutter only)

• STAINLESS-STEEL MINI BOWL

Optional extra: 3.5-litre mini bowl for the R 8 and 4-litre mini bowl for the R 10 and R 15, plus 100% stainless steel blade assembly, easily taken apart, for making quick sauces, chopping herbs and carrying out all those other last-minute tasks or small batches.

• **STAINLESS-STEEL MINI BOWL WITH 3.5-LITRE CAPACITY FOR R 8 AND 4-LITRE CAPACITY FOR R 10 • R 15**



1. Place the mini bowl over the chimney of the large bowl, then turn it until it fits into position over the lug. The mini bowl handles should now be lined up with those of the large bowl.

2. Next, slot the 100% stainless-steel blade assembly over the motor shaft and place the mini lid on top of the mini bowl to avoid splashing. Next, close the machine lid.

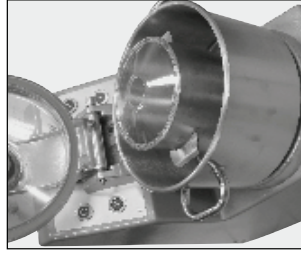

• **SERRATED KNIFE - FINE SERRATED KNIFE**

The blade support can be fitted either with two coarse serrated blades or with two fine serrated blades.

The **serrated blades** are mainly used:

- for making pastry
- for grinding.

The **fine serrated blades** are mainly used for:

- chopping parsley
- blending.

• **VACUUM KIT R-VAC®**

Your cutter can perform vacuum processing without any need for modifications.

Simply assemble the vacuum kit R-VAC®, patented by ROBOT COUPE on to the lid and connect it to a vacuum pump (see instructions page 13).

If you already have a vacuum packing machine, you can connect the kit to the vacuum pump on this machine.

The R-VAC® kit was specifically designed so that liquids can be added to the mixture during processing, whilst keeping the food under vacuum.

HYGIENE

Bowl, lid assembly and blade assembly should be rinsed between batches to avoid cross mixing foods. When switching from one type of foodstuff to another or switching from uncooked foods to cooked foods the appliance must be thoroughly cleaned using detergents and disinfectant.

• **WARNING: NEVER USE PURE BLEACH.**

- Disassemble the blade before cleaning (page 14 and 15).
- Clean and rinse the blade and bowl components in hot soapy water before sanitizing.
- Use sanitizing solution diluted according to the manufactures directions. Do not use pure bleach for sanitizing purposes
- Allow components to air dry before sanitizing.
- Do not store wet components in the bowl.
- If the blade is to be used immediately it may be reassembled, otherwise allow blade components to air dry on a plastic rack before assembly for storage.

CLEANING



WARNING

As a precaution, always unplug your appliance before cleaning it (hazard of electrocution) and handle the blades with care (hazard of injury).

When the machine has completed its task, open the lid by releasing the locking handle.

Press down firmly on the handles, unlock the bowl by turning it in a clockwise direction, then pull it upwards to free it.

If the food has a solid consistency, remove the blade assembly by grasping blade knob to remove the blade then empty the bowl.

CAUTION CUT HAZARD

Always use spatula or scraper to remove food from the blades, never use bare hands.

To remove food residue from the blades, put the bowl back, slot the blade assembly back over the motor shaft, and run the machine at high speed. Similarly, for precleaning, pour a couple of litres of hot water into the bowl and run the machine for a few seconds at high speed.

The machine can be washed with a kitchen spray (though not with a power washer).

After cleaning the blade assembly, always completely dry the blades to prevent rusting or air dry metal parts on a plastic rack before assembling the blade for overnight storage.

When the machine is not in use, turn off at service disconnect or disconnect from the power supply and leave the lid open.

Never immerse the motor base in water. Clean using a damp cloth or sponge.

• BOWL

After removing the lid, release the bowl by rotating the bowl clockwise about ¼ turn. It can then be lifted vertically from the motor support. If the bowl contains a liquid preparation, leave the blade assembly inside to ensure that it remains completely watertight.

If the food has a solid consistency, remove the blade and empty the bowl.

Replace the bowl, place the blade on the shaft and switch on the machine in order to remove any mixture which may have stuck to the blade.

The bowl can be prewashed by pouring hot water into it and running the machine for a few minutes.

• BLADE (See page 14 and 15)

The R 8 is supplied with a smooth 2-blade assembly.

The R 10, 15 and 20 are supplied with a smooth 3-blade assembly.

The Blixer® 8 is supplied with a fine-serrated 2-blade assembly.

The Blixer® 10, 15 and 20 are supplied with a fine-serrated 3-blade assembly.

The 100% stainless-steel blade assemblies of our cutter and Blixer® can be entirely taken apart for easy cleaning

After cleaning the blade, always dry well to prevent rusting.

• SCRAPER ARM (Blixer® only)

To clean the scraper arm, dismantle it as follows. Hold the scraper arm in one hand and the hub in the other hand (drawing 1). Press the two pieces one on the other, and turn the handle of 45° anticlockwise (drawing 2). Then it is possible to pull out the two pieces (the scraper arm and the handle) from the lid and clean them (drawing 3).

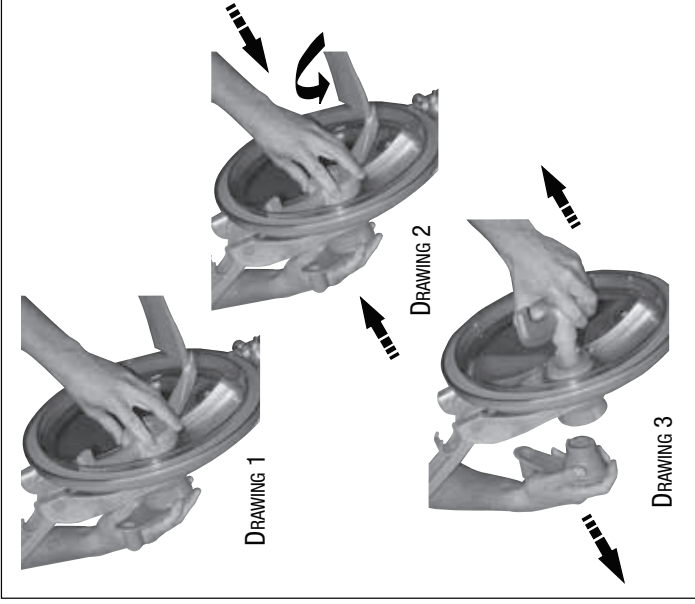

MAINTENANCE

• DISMANTLING THE BLADE ASSEMBLY

R 8 • R 10 • R 15 • R 20
Blixer® 8 • Blixer® 10 • Blixer® 15 • Blixer® 20 blade

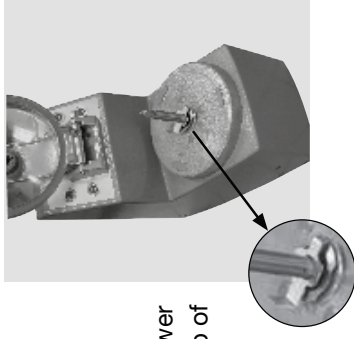

- Slide the cutter right down the motor shaft.
- Make sure that the lower blade is resting on top of the blade tool.

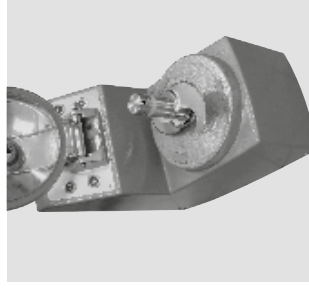

- Loosen the locking nut with the metal wrench.

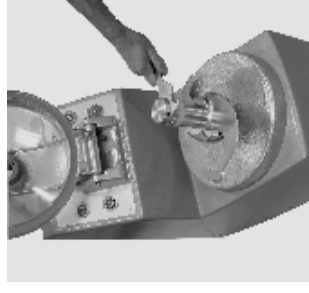

- Disconnect the machine.
- Remove the bowl.
- Position the blade tool on the motor shaft.

- To replace the knife, simply do the same in reverse.



IMPORTANT

Check that your detergent is suitable for cleaning the plastic parts.

Certain washing agents are too alkaline (e.g. high levels of caustic soda or ammonia) and totally incompatible with certain types of plastic, causing them to deteriorate rapidly.



IMPORTANT

Like the bowl and lid, the blade assembly should also be removed for cleaning after use.

Always allow all metal parts, especially knives, to dry completely on a plastic rack before assembling components for storage to avoid corrosion.

• **MINI BOWL BLADE (Cutter only)**

A special tool designed to make it easier to remove the blade assembly from the mini bowl is supplied with the machine.



• **SCRAPER ARM (Blixer® only)**

The scraper arm is equipped with rubber pieces which are wearing parts. They should be replaced occasionally to always ensure an optimum efficiency of the scraper arm. These pieces are easy to dismantle and to reassemble.

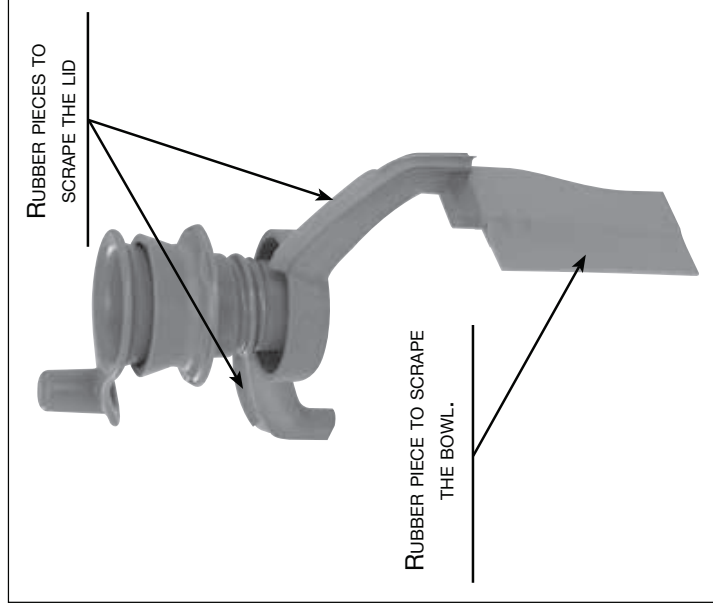

• **BLADES**

Only the blades on cutters R 8, R 10, R 15 and R 20 can be sharpened.

It is strongly recommended, after each use, to give the blades a quick sharpen with a sharpening steel, especially after cutting parsley.

They should then be sharpened properly once a month with the very fine whetstone that comes with the appliance.

The quality of the cut depends mainly on the sharpness of your blades and the degree of wear.

The blades are actually wearing parts, which should be replaced occasionally to ensure consistent quality in the final product.

• **SEAL**

The seal on the motorshaft should be lubricated regularly using a food safe lubricant.

In order to keep the motor completely watertight, it is advisable to check the gasket regularly for wear and tear and replace if necessary.

Replace shaft seals each 3 to 6 months. Lubricate seals with food grade grease.

• **LID SEAL**

The lid is designed to be completely watertight. In order to ensure that it remains that way, you may have to change the seal occasionally, depending on how regularly you use your machine.

If you do not use your machine regularly, between uses it is advisable to leave the lid open to preserve all these features.

DIAGNOSTIC SYSTEM



REMEMBER

The control system requires the lid be opened and closed, once after switching your appliance on.

This sequence will check the correct operation of the lid arm safety switch. At this stage, if all the conditions are met for operation, the light will stop flashing and stay on.

Your appliance is equipped with a green light that indicates the operational status of your machine:

- **no light:** see paragraph 1.
- **flashing light:** see paragraph 2.
- **steady light:** your appliance is ready to run.

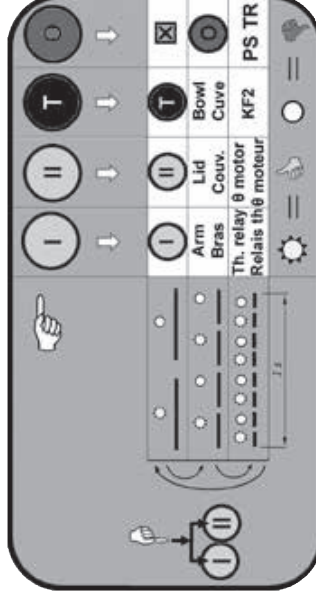

REMEMBER

Always switch your machine off before carrying out any cleaning or maintenance, All repair and maintenance work must be carried out by a qualified technician.

1. No light

This means that either your appliance is switched off or there is a problem with the power supply.

Measure the voltage at the power outlet and check that the plug is correctly wired.

If the problem persists, the control board must be replaced.

2. Flashing light

One or more of the safety devices or thermal protectors is not responding properly.

These safety devices comprise 3 presence sensors, a thermal relay and a motor overload protector.

The status light and the control buttons offer a means of testing the machine's components and safety devices before performing any service operation.

There is no point continuing with the test once you have detected a fault. Instead, rectify the problem first and start the test afresh.

• GENERAL POINTS:

The previous table helps you following the test procedure.

It identifies the device that can be tested as follow :

Each of the 4 columns corresponds to one of the 4 buttons, pressed one after the other by the operator.

The 3 rows correspond to the 3 successive test levels.

You can change the level by simultaneously pressing **buttons I and II**. Each level is identified by the flashing speed of the light: slow for level one, fast for level two and very fast for level three. To return to testing level 1, the **buttons I and II** must be simultaneously pressed a further time.

When none of the buttons is being pressed, the light flashes to indicate the current testing level.

When one of the buttons is continuously pressed, it indicates the actual status of the corresponding device: on = OK, off = problem.

• TEST SEQUENCE:

When the green light flashes, start by pressing **button I** to test that it is working properly (similarly, test **button II** and then test **button T**).

At this level, **button O** can not be tested yet.

Press **buttons I and II** simultaneously to move up to testing level 2, indicated by more rapid flashing speed of the indicator light.

At level 2, **buttons I, II, T and O** allow to test the presence sensors of the lid, the base and the bowl, and **button O**, respectively.

Press **buttons I and II** simultaneously to move up to testing level 3, indicated by very rapid flashing speed of the indicator light.

At level 3, **buttons I, II, T and O** allow to test the thermal relay + the motor thermal protector, the mains voltage, the phase-frequency detector, and the configuration jumpers + braking relay, respectively.

Press **buttons I and II** simultaneously to return to the normal flashing speed and therefore to testing level 1.

• SHARPENING - CHECKS

- If the test sequence reveals a button default, check first the button's contact block operation and its wiring.

- If the test sequence reveals a problem with one of the presence sensors, check that the removable parts of your cutter mixer (bowl, lid and arm) are all in place. If the problem persists, check the presence sensors themselves and their wiring.

- If the test sequence indicates that the thermal relay is faulty, check it is correctly set (automatic position and current setting in accordance with the electrical diagram);

- If the test indicates that the motor overload protector is faulty, check its wiring;

- If a "voltage" or "Phase + Frequ" error is detected, check that the machine is supplied with the correct voltage. Also check that the plug attachment is correctly wired.

- If a "Jumpers + KFR" error message is detected, check that the configuration jumpers on the control board are set according to the electrical diagram.

OPERATING INSTRUCTIONS FOR THE VACUUM KIT R-VAC® (Cutter only)

1° ASSEMBLING THE VACUUM KIT R-VAC®

- Insert filter N° 2 into body N° 3
- Screw part N° 1 onto body N° 3 (the tube is fed through body N° 3).

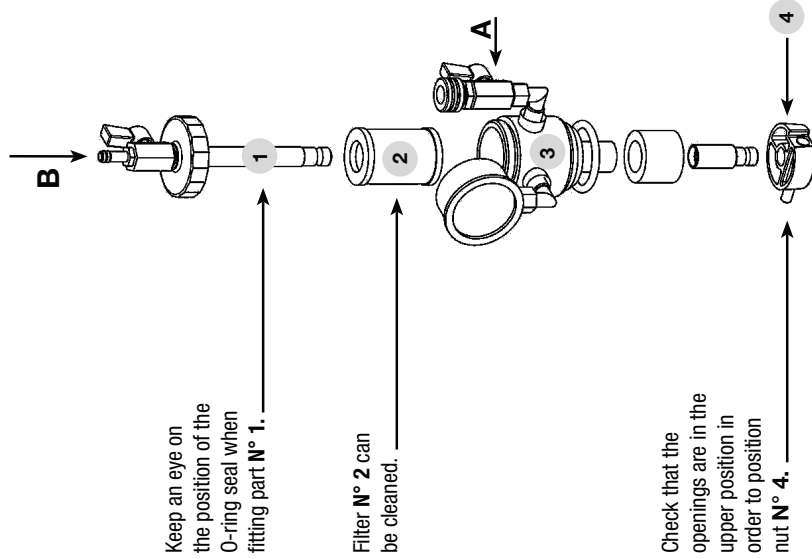

2° PLACING THE VACUUM KIT R-VAC® ON THE LID

- Insert the vacuum kit into the cone section of the plastic part N° 5. The latter should be screwed into the lid guide N° 6 which, in turn, should be slotted into the aluminium lid arm N° 8. The lid N° 9 should also be clipped onto the lid guide N° 6.

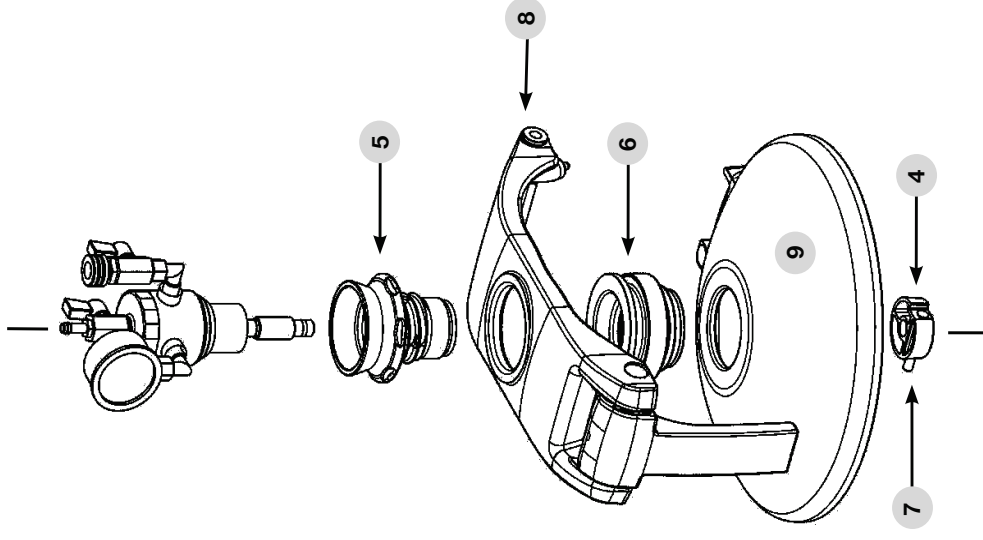

3° CLIPPING THE RETAINER N° 4

- Hold the bell in the palm of your hand and press the pusher N° 7 in with your thumb.
- Fit the nut onto the cylindrical section which juts out over the lid.
- Release button N° 7.
- The pusher should return to its original position. If it does not, press the bell gently so that it automatically clicks into place.
- Check that the bell is properly attached to the tube N° 1, in order to avoid all risk of the bell or kit falling off.

4° USING THE VACUUM KIT R-VAC®

- Connect up the vacuum pump to valve A, check that the latter is open (lever in shaft of connector).
- Shut valve B (perpendicular lever).



NOTE

Preheat the vacuum pump (approx. 15 minutes) to check that both it and the vacuum kit are working properly. Similarly, leave the pump running for 15 minutes after completing the task in order to evacuate the condensation.

5° ADDING LIQUID TO THE MIXTURE

- Attach a tube to valve B.
- Immerse the other end of this tube in the liquid to be added.
- Open valve B slowly ; once the liquid has been added, shut valve B.

FITTING AND USING THE BLADE ASSEMBLY (Cutter only)



• 2-BLADE ASSEMBLY:

We recommend you use the two-blade assembly for processing small amounts (less than half the maximum capacity indicated on page 7).

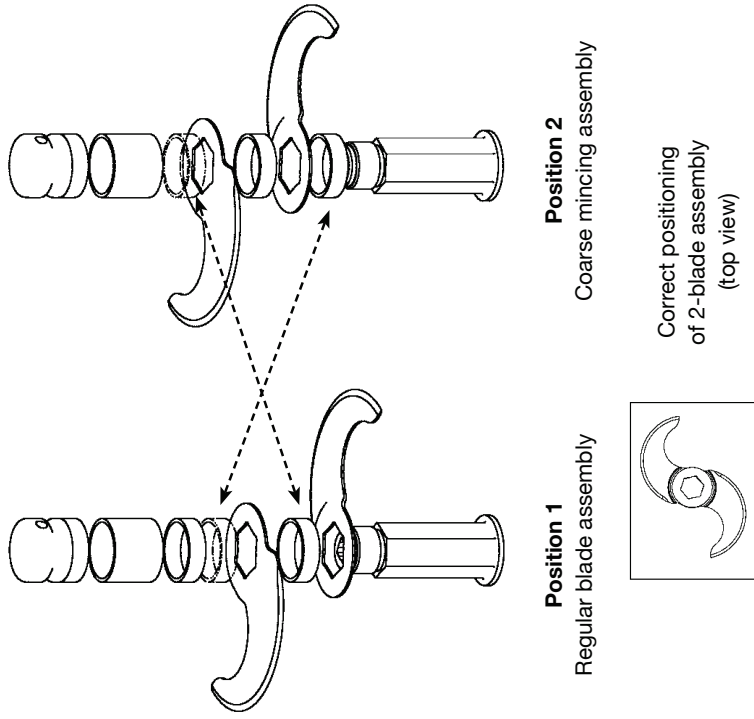

POSITION 1: No spacer between lower blade and blade support.

- For **fine chopping** and **emulsions**.
- For **grinding** and **kneading**.

DISMANTLING:

- Unscrew the screw nut.
- Remove the rings and blades.

• 3-BLADE ASSEMBLY:

We recommend you use the 3-blade assembly for processing large quantities of more than half the maximum limit indicated, with the exception of liquid or blended preparations for which we strongly recommend you use the 2-blade assembly. **For preparations of this kind, it is recommended using the low speed in order to obtain the best results.**

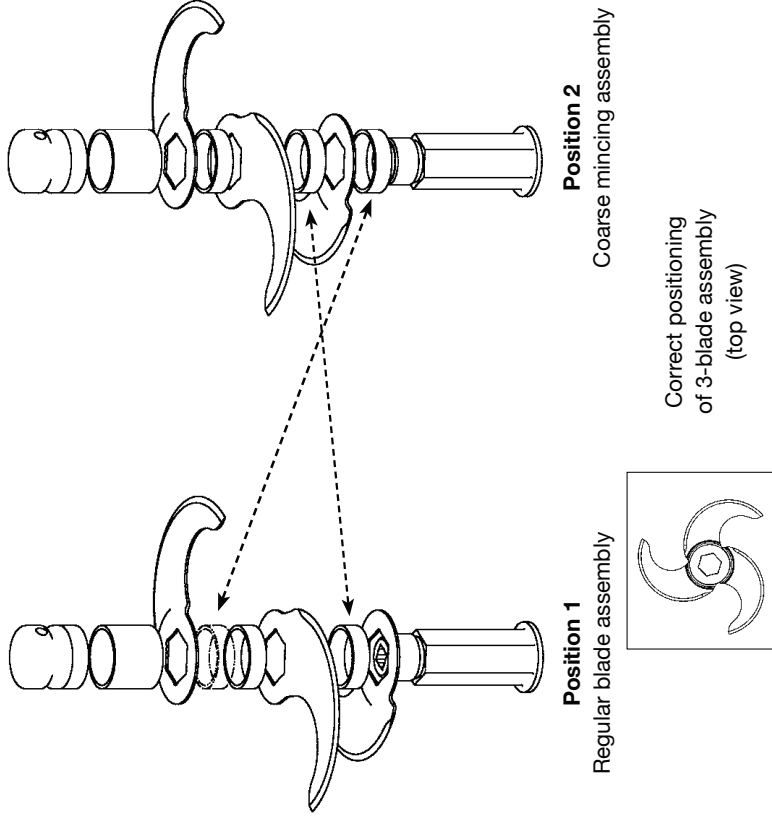

POSITION 2: With spacer between lower blade and blade support.

- For **coarse chopping**

ASSEMBLING:

- Fit the blades and spacers so that they are the right distance apart, according to the:
 - type
 - weight and
 - volume of the foodstuffs to be processed.

WARNING: The plastic ring must be placed immediately under the locking nut.

FITTING AND USING THE BLADE ASSEMBLY (Blixer® only)



• 2-BLADE ASSEMBLY:

We recommend you use the two-blade assembly for processing small amounts.

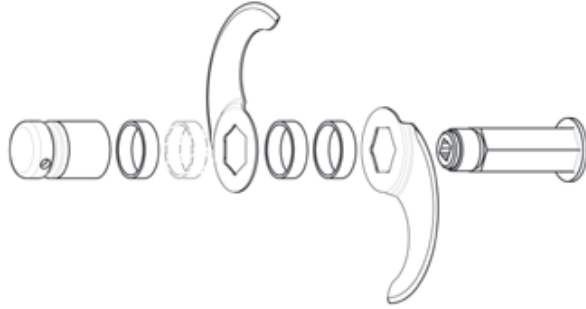

Correct positioning
of 2-blade assembly
(top view)

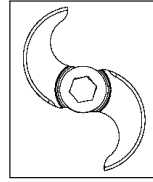

- DISMANTLING:**
- Unscrew the screw nut.
 - Remove the rings and blades.

• 3-BLADE ASSEMBLY (except for the Blixer® 8):

We recommend you use the 3-blade assembly for processing large quantities of more than half the maximum limit indicated, with the exception of liquid or blended preparations for which we strongly recommend you use the 2-blade assembly. **For preparations of this kind, it is recommended you use the first speed in order to obtain the best results.**

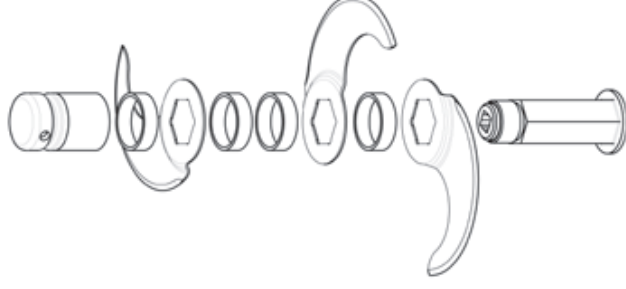

Correct positioning
of 3-blade assembly
(top view)

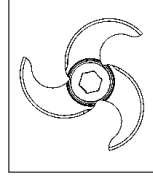

- MONTAGE:**
- Fit the blades and spacers so that they are the right distance apart, according to the:
 - type
 - weight and
 - volume of the foodstuffs to be processed.

WARNING: The plastic spacer goes below the nut + long spacer assembly.

TECHNICAL SPECIFICATIONS

• WEIGHT & DIMENSIONS

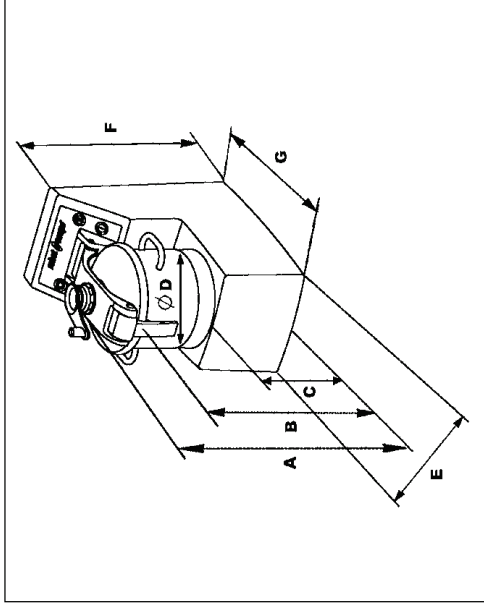

Models	Dimensions (in inches)							Weight (lb)	
	A	B	C	D	E	F	G	Net	Gross
Blixer® 8 R 8	23	17 1/2	10	11 13/16	12 3/8	20 11/16	21 7/16	88	93
Blixer® 10 R 10	26	20 1/2	11	11 13/16	13 9/16	23 3/8	22 1/16	99	126
Blixer® 15 R 15	26 3/4	21 1/4	11 13/16	13 3/8	14 9/16	24 3/8	24 1/4	108	137
Blixer® 20 R 20	30	24	12 3/4	12 3/4	14 15/16	27 9/16	24 7/16	165	194

• WORKING SPACE

We recommend that you position the Blixer® 8, R 8 - Blixer® 10, R 10 on a stable worktop so that the upper edge of the large feed head is at a height of between 1.20 and 1.30 m.

We advise you to position your Blixer® 15, R 15 - Blixer® 20, R 20 on a stable surface. There is no recommended working height since this is a floor-standing model.

These models are fitted:

- with a **thermal relay that stops the machine when it is overloaded**. The thermal relay resets itself automatically after a few tens of seconds.
- a thermal protector insterted in the motor winding that stops the machine if the motor temperature rises above the maximum limit. It his happens, allow the machine to cool down for several minutes (about 10 to 20 minutes) before attempting to restart it.



WARNING

- Never try to override the locking and safety systems.**
- Never insert an object into the container where the food is being processed.**
- Never push the ingredients down with your hand.**
- Do not overload the appliance.**
- Never switch the appliance on when it is empty.**

SAFETY



WARNING

- The blades are extremely sharp. Handle with care.**
- Wear cut resistant gloves when handling the blades.**

This ROBOT COUPE range of Cutter and Blixer® is equipped with a mechanical safety system and a motor brake. Moreover, the machine will not operate unless the bowl and lid are correctly positioned on the motor base.

The motor stops as soon as the lid is opened. However, if you are processing liquid ingredients, it is a good idea to stop the machine before opening the lid, to avoid splashing.

To restart the machine, simply close the lid and press the low or high speed button.

SERVICE

See warranty first then;

Should your unit require service, check online at www.robotcoupeusa.com to find the nearest Robot Coupe Authorized Service Agency or call the factory to see where local service is available.

If you wish your unit to be serviced at the factory, call for return instructions and ship the unit prepaid to our factory address.

PH : 1-800-824-1646

Robot Coupe U.S.A., Inc.

Service Department Repair

264 South Perkins Street

Ridgeland, MS 39157

For service in Canada contact the Robot Coupe USA factory for repair instructions.

robot  **coupe**[®]

**ELECTRICAL AND WIRING
DIAGRAMS**

R8E - R10E - R15E - R20E

BLIXER®8E - BLIXER®10E - BLIXER®15E - BLIXER®20E

200V/50-60Hz - 220V/60Hz - 230V/50Hz - 380V/60Hz - 400V/50Hz - 415V/60Hz

SCHEMA ELECTRIQUE

ELECTRIC DIAGRAM

ELEKTRISCHES SCHALTBIKD

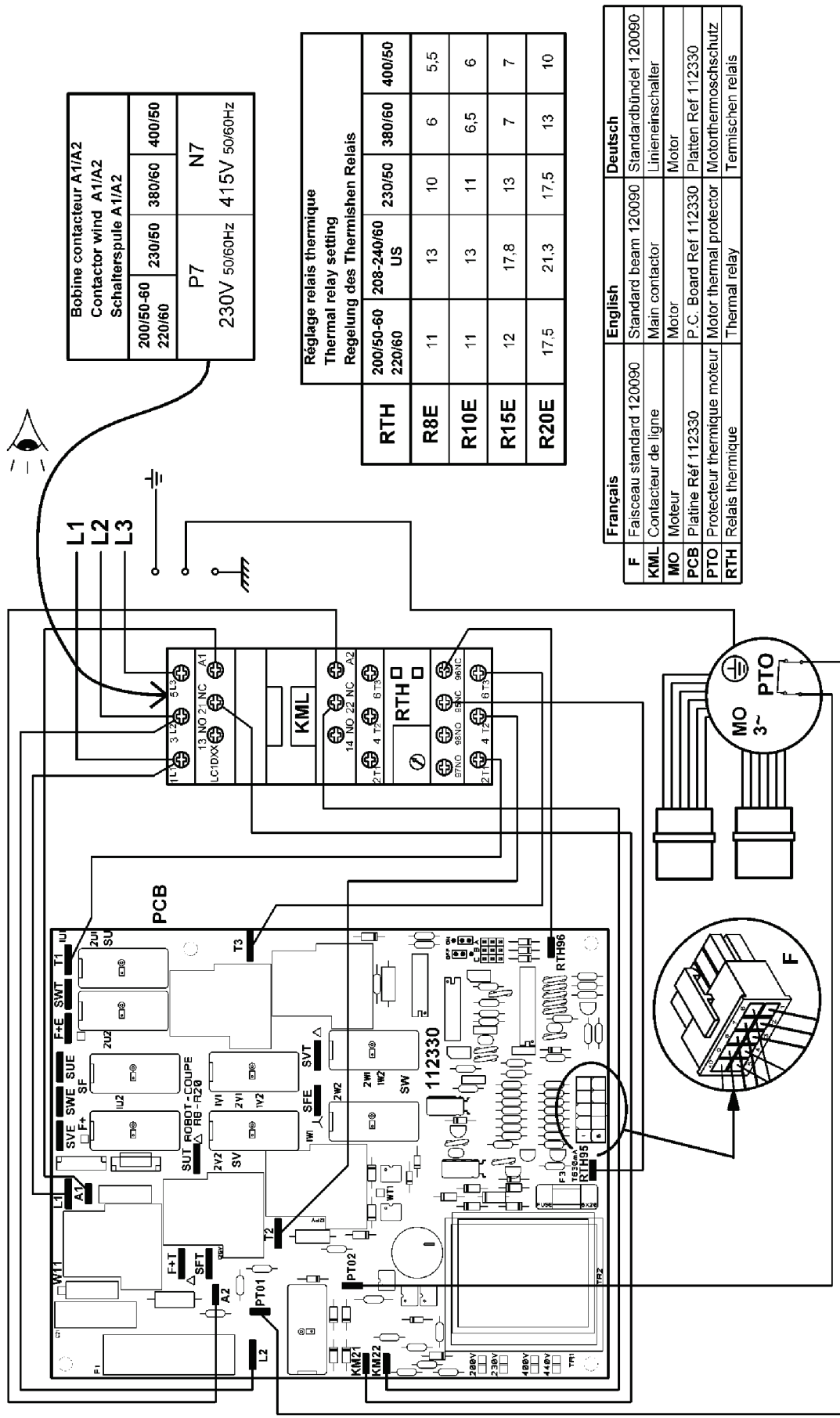

Bobine contacteur A1/A2 Contactor wind A1/A2 Schalterspule A1/A2	
200/50-60 220/60	230/50 380/60 400/50
P7	N7
230V 50/60Hz 415V 50/60Hz	

Réglage relais thermique Thermal relay setting Regelung des Thermischen Relais					
RTH	200/50-60 220/60	208-240/60 US	230/50	380/60	400/50
R8E	11	13	10	6	5,5
R10E	11	13	11	6,5	6
R15E	12	17,8	13	7	7
R20E	17,5	21,3	17,5	13	10

Français	English	Deutsch
F Faisceau standard 120090	Standard beam 120090	Standardbündel 120090
KML Contacteur de ligne	Main contactor	Linieineinschalter
MO Moteur	Motor	Motor
PCB Platine Ref 112330	P.C. Board Ref 112330	Platten Ref 112330
PTO Protecteur thermique moteur	Motor thermal protector	Motorthermoschutz
RTH Relais thermique	Thermal relay	Thermischen relais

robotcoupe®

N° 402833 d 1/3

Maj : 02/12

R8E - R10E - R15E - R20E

BLIXER®8E - BLIXER®10E - BLIXER®15E - BLIXER®20E

200V/50-60Hz - 220V/60Hz - 230V/50Hz - 380V/60Hz - 400V/50Hz

SCHEMA ELECTRIQUE

ELECTRIC DIAGRAM

ELEKTRISCHES SCHALTBIKD

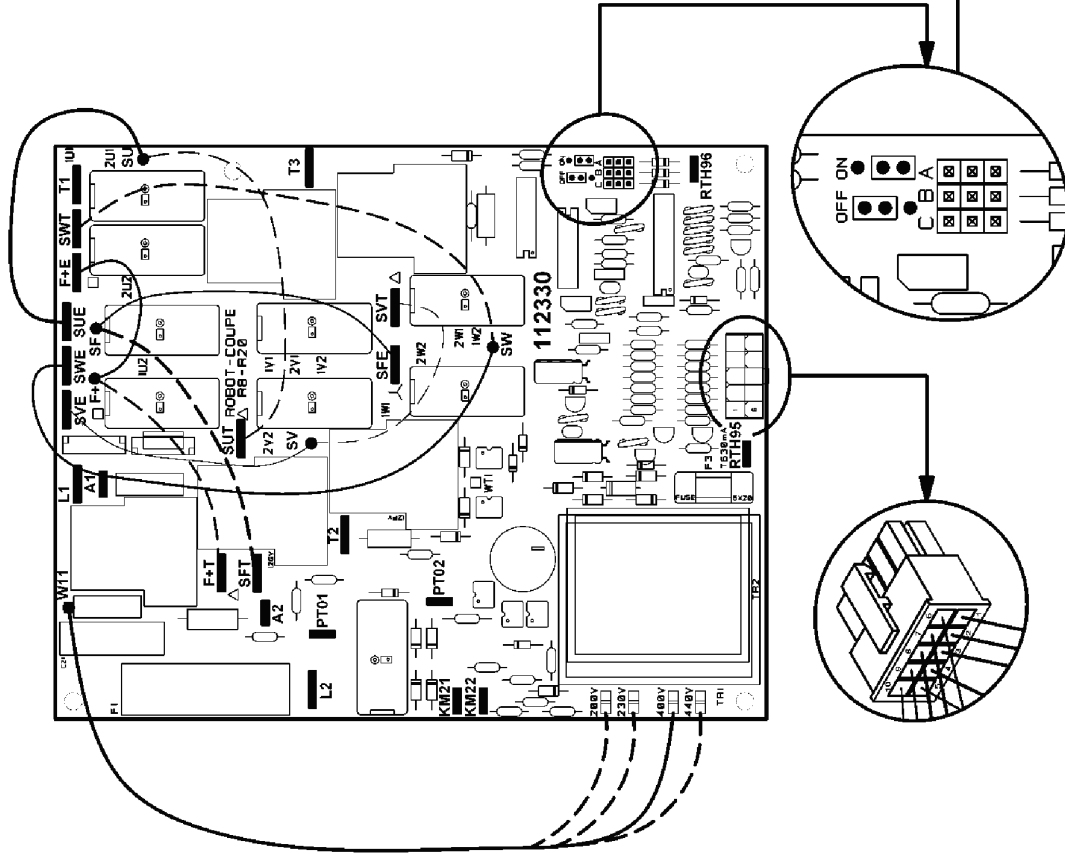

CHECK LIST



Il y a 6 fils à commuter suivant la tension d'alimentation + contrôlé tension bobine.
 There are 6 wires to connect according to the supply voltage + check voltage wind.
 Es gibt 6 Kabeln müssen ungeschalt werden entsprechend der Stromversorgung
 + Spannungskontrolle windt auf.

**LE NON RESPECT DE CES INSTRUCTIONS DE CABLAGE ANNULERA VOTRE GARANTIE.
 FAILURE TO FOLLOW THESE WIRING INSTRUCTIONS WILL VOID YOUR WARRANTY.
 BEI NICHTBEFOLGUNG DER VERKABELLUNGSANLEITUNGEN VERFALLT DIE GARANTIE.**

Tension d'alimentation / Supply voltage / Stromspannung		200 V	220 V - 230 V	380 V - 400 V	440 V
Fils Wires Kabeln	WT1	200 V	230 V	400 V	440 V
gris / gray / grau	F+		F+T		F+E
bleu / blue / blau	SF		SFT		SFE
blanc / white / weiß	SU		SUT		SUE
rouge / red / rot	SV		SVT		SVE
jaune / yellow / gelb	SW		SWT		SWE

R8E - R10E - R15E - R20E

BLIXER®8E - BLIXER®10E - BLIXER®15E - BLIXER®20E

200V/50-60Hz - 220V/60Hz - 230V/50Hz - 380V/60Hz - 400V/50Hz

SCHEMA ELECTRIQUE

ELECTRIC DIAGRAM

ELEKTRISCHES SCHALTBILD

	Français	English	Deutsch
BP1	Bouton poussoir vitesse 1	Pusher switch speed 1	Geschwindigkeitsschalter 1
BP2	Bouton poussoir vitesse 2	Pusher switch speed 2	Geschwindigkeitsschalter 2
BPA	Bouton poussoir arrêt	Off switch	Stopschalter
BPP	Bouton poussoir impulsion	Pulse switch	Impulsschalter
F	Faisceau standard 120090	Standard beam 120090	Standardbündel 120090
ISBC	Interrupteur de sécurité bras	Arm safety switch	Kontakt Armverschluss
ISCU	Interrupteur de sécurité couvercle	Lid safety switch	Schalter zur Deckelsicherheit
LED	Interrupteur de sécurité cuve	Bowl safety switch	Platten Ref 112330
LED	LED	LED	LED

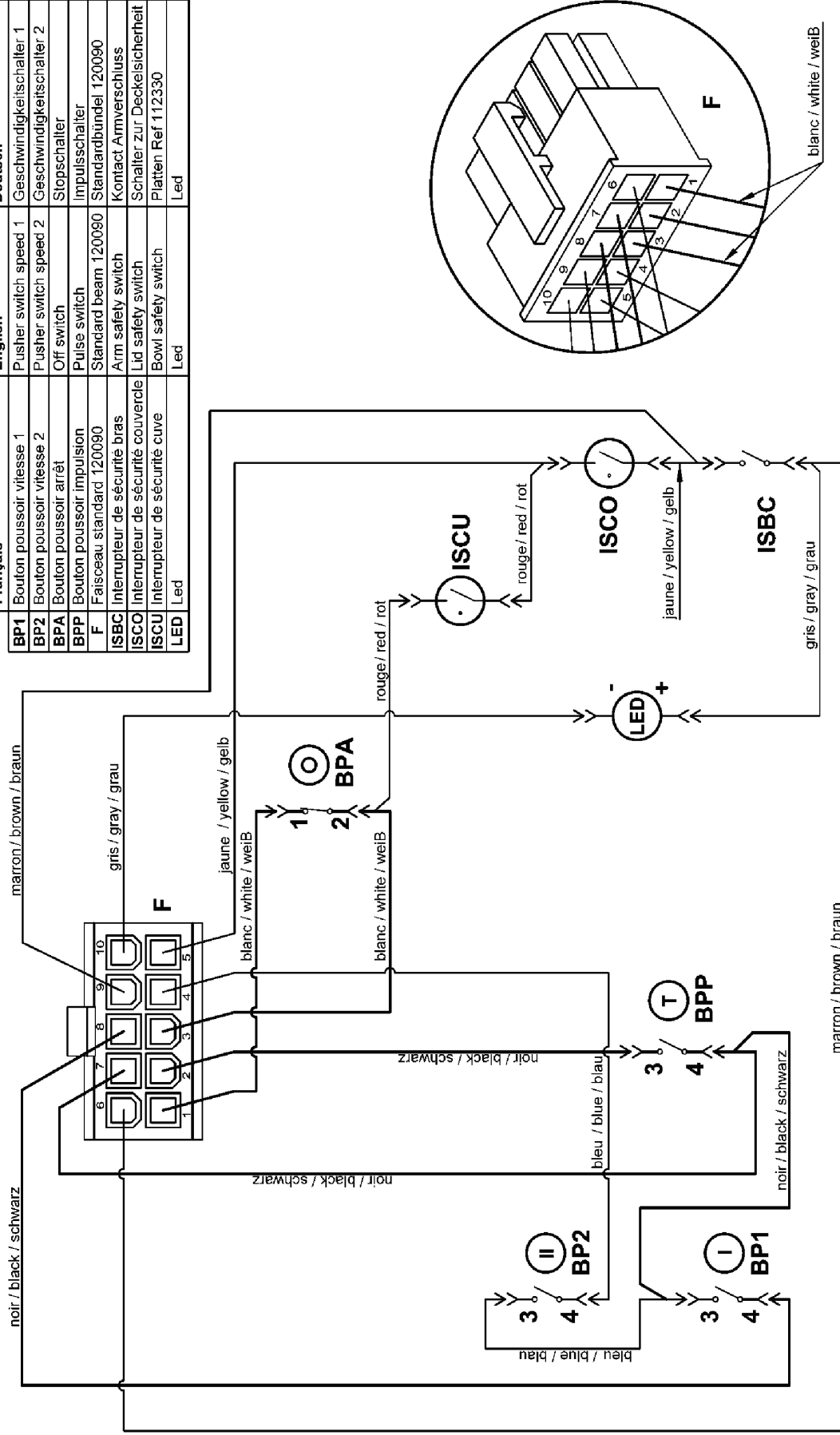

robot coupe®

N° 402833 d 3/3

Maj : 02/12



robot coupe®

Robot Coupe U.S.A., Inc.,

Phone: 800/824-1646 - 601/898-8411

264 South Perkins St., Ridgeland, MS 39157

e-mail: info@robotcoupeusa.com

website: www.robot-coupe.com



37002314451409

Réf.: 451 409 - 11/10/2023 - USA