



Architect/Engineering Specifications:

Wall mount elevated atmospheric vacuum breaker with polished chrome plated brass body, 3/8" NPT female flanged inlet and outlet. Certified to ASME A112.18.1/CSA B125.1, NSF 61-Section 9, NSF 372 and ASSE 1001.

Job Name \_\_\_\_\_

Model Specified \_\_\_\_\_ Quantity \_\_\_\_\_

Variations Specified \_\_\_\_\_

Date \_\_\_\_\_

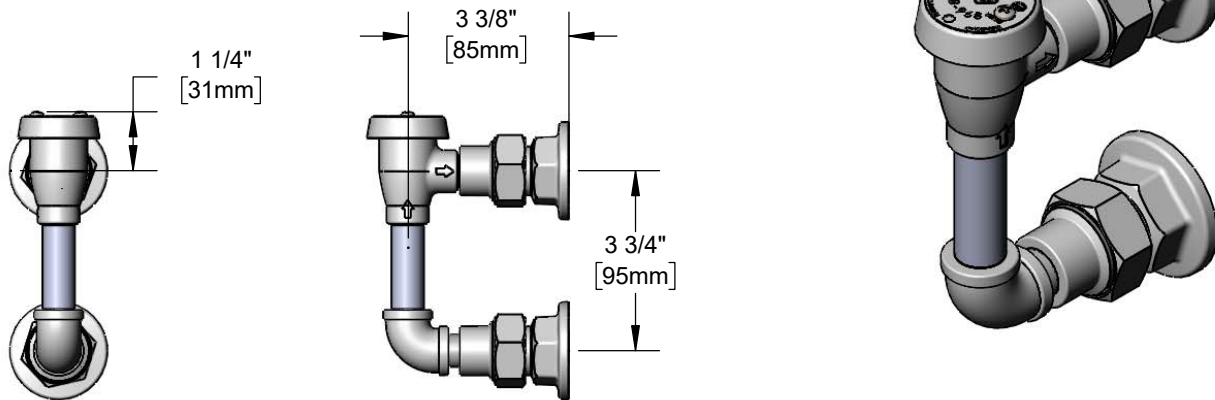

Features & Benefits:

- Wall mount elevated atmospheric vacuum breaker
- 3/8" NPT female flanged inlet and outlet
- Material: Polished chrome plated brass

Product Compliance:

- ASME A112.18.1 / CSA B125.1
- NSF 61 - Section 9
- NSF 372 (Low Lead Content)
- ASSE 1001 (VB)

Warranty: One Year (Limited)

Performance Data:

- Pressure: 20 - 125 psi
- Temperature: 40 °F - 140 °F
- Flow Rate: 13.70 GPM @ 60 psi

