

Frymaster[®]

We Fit the Way You Fry[™]

FilterQuick[™] FQE30U easyTouch[®] Electric Fryer

Installation, Operation and Maintenance Manual

This manual is updated as new information and models are released. Visit our website for the latest manual.



FOR YOUR SAFETY

Do Not Store or use gasoline
or other flammable vapors
and liquids in the vicinity of
this or any other appliance.

⚠ CAUTION

READ THE INSTRUCTIONS BEFORE USING THE FRYER.

Keep these instructions for future reference.



Part Number: FRY_IOM_8197522 10/2025

Original Instructions



WELBILT
an Ali Group Company

NOTICE

IF, DURING THE WARRANTY PERIOD, THE CUSTOMER USES A PART FOR THIS FRYMASTER DEAN EQUIPMENT OTHER THAN AN **UNMODIFIED** NEW OR RECYCLED PART PURCHASED DIRECTLY FROM FRYMASTER DEAN OR ANY OF ITS FACTORY AUTHORIZED SERVICERS, AND/OR THE PART BEING USED IS MODIFIED FROM ITS ORIGINAL CONFIGURATION, THIS WARRANTY WILL BE VOID. FURTHER, FRYMASTER DEAN AND ITS AFFILIATES WILL NOT BE LIABLE FOR ANY CLAIMS, DAMAGES OR EXPENSES INCURRED BY THE CUSTOMER WHICH ARISE DIRECTLY OR INDIRECTLY, IN WHOLE OR IN PART, DUE TO THE INSTALLATION OF ANY MODIFIED PART AND/OR PART RECEIVED FROM AN UNAUTHORIZED SERVICER.

NOTICE

This appliance is intended for professional use only and is to be operated by qualified personnel only. A Frymaster Authorized Servicer (FAS) or other qualified professional should perform installation, maintenance, and repairs. Installation, maintenance, or repairs by unqualified personnel may void the manufacturer's warranty. See Chapter 1 of this manual for definitions of qualified personnel.

NOTICE

This equipment must be installed in accordance with the appropriate national and local codes of the country and/or region in which the appliance is installed. See NATIONAL CODE REQUIREMENTS in Chapter 2 of this manual for specifics.

NOTICE TO U.S. CUSTOMERS

This equipment is to be installed in compliance with the basic plumbing code of the Building Officials and Code Administrators International, Inc. (BOCA) and the Food Service Sanitation Manual of the U.S. Food and Drug Administration.

WARNING

Improper installation, adjustment, maintenance or service, and unauthorized alterations or modifications can cause property damage, injury, or death. Read the installation, operating, and service instructions thoroughly before installing or servicing this equipment.

FOR YOUR SAFETY

Do not store or use gasoline or other flammable liquids or vapors in the vicinity of this or any other appliance.

NOTICE TO OWNERS OF UNITS EQUIPPED WITH TOUCH SCREEN CONTROLLERS

U.S.

This device complies with Part 15 of the FCC rules. Operation is subject to the following two conditions: 1) This device may not cause harmful interference, and 2) This device must accept any interference received, including interference that may cause undesired operation. While this device is a verified Class A device, it has been shown to meet the Class B limits.

CANADA

This digital apparatus does not exceed the Class A or B limits for radio noise emissions as set out by the ICES-003 standard of the Canadian Department of Communications.

Cet appareil numérique n'émet pas de bruits radioélectriques dépassant les limites de classe A et B prescrites dans la norme NMB-003 édictée par le Ministre des Communications du Canada.

DANGER

When installed, this appliance must be electrically grounded in accordance with local codes, or in the absence of local codes, with the National Electrical Code, ANSI/NFPA 70, the Canadian Electrical Code, CSA C22.2, or the appropriate national code of the country in which installed.

WARNING

The appliance must be installed and used in such a way that any water cannot contact the fat or oil.

NOTICE

This appliance is intended to be used for commercial applications, for example in kitchens of restaurants, canteens, hospitals and in commercial enterprises such as bakeries, butcheries, etc., but not for continuous mass production of food.

⚠ DANGER

The front ledge of this appliance is not a step! Do not stand on the appliance. Serious injury can result from slips or contact with the hot oil.

NOTICE

Drawings and photos used in this manual are intended to illustrate operational, cleaning and technical procedures and may not conform to onsite management operational procedures.

⚠ DANGER

The crumb tray in fryers equipped with a filter system must be emptied into a fireproof container at the end of frying operations each day. Some food particles can spontaneously combust if left soaking in certain shortening material.

⚠ DANGER

When using a sediment basket, it **MUST** be removed and emptied prior and during each filtration. Some food particles can spontaneously combust if left soaking in certain shortening material.

⚠ WARNING

Do not bang fry baskets or other utensils on the fryer's joiner strip. The strip is present to seal the joint between the fry vessels. Banging fry baskets on the strip to dislodge shortening will distort the strip, adversely affecting its fit. It is designed for a tight fit and should only be removed for cleaning.

⚠ DANGER

Adequate means must be provided to limit the movement of this appliance without depending on or transmitting stress to the electrical conduit. A restraint kit is provided with the fryer. If the restraint kit is missing contact your local KES.

⚠ DANGER

This fryer has a power cord (three-phase) for each frypot. Prior to movement, testing, maintenance and any repair on your Frymaster fryer; disconnect ALL electrical power cords from the electrical power supply.

⚠ DANGER

Keep all items out of drains. Closing actuators may cause damage or injury.

⚠ WARNING

This appliance is not intended for use by children under the age of 16 or persons with reduced physical, sensory or mental capabilities, or lack of experience and knowledge, unless they have been given supervision concerning use of the appliance by a person responsible for their safety. Do not allow children to play with this appliance.

⚠ DANGER

This appliance must be connected to a power supply having the same voltage and phase as specified on the rating plate located on the inside of the appliance door.

 **WARNING** 

Use caution and wear appropriate safety equipment to avoid contact with hot oil or surfaces that may cause severe burns or injury.

 **DANGER**

Do not spray aerosols in the vicinity of this appliance while it is in operation.

 **DANGER**

No structural material on the fryer should be altered or removed to accommodate placement of the fryer under a hood. Questions? Call the Frymaster Dean Service Hotline at 1-800-551-8633.

 **WARNING**

NEVER drain boil out or cleaning solution into a shortening disposal unit (SDU), a built-in filtration unit, a portable filter unit or an OQS (Oil Quality Sensor). These units are not intended for this purpose and will be damaged by the solution and void the warranty.

 **DANGER**

Prior to movement, testing, maintenance and any repair on your Frymaster fryer; disconnect ALL electrical power cords from the electrical power supply.

NOTICE

No warranty is provided for any Frymaster fryer used in a mobile or marine installation or concession. Warranty protection is only offered for fryers installed in accordance with the procedures described in this manual. Mobile, marine or concession conditions of this fryer should be avoided to ensure optimum performance.

 **WARNING**

Do not block the area around the base or under the fryers.

 **WARNING**

Do not use water jets to clean this equipment.

 **WARNING**

If the electrical power supply cord is damaged, it must be replaced by a Frymaster Factory Authorized Servicer or a similarly qualified person in order to avoid a hazard.

 **WARNING**

Operation, installation, and servicing of this product may expose you to chemicals/products including [Bisphenol A (BPA), glass wool or ceramic fibers, and crystalline silica], which is [are] known to the State of California to cause cancer, birth defects or other reproductive harm. For more information go to www.P65Warnings.ca.gov.

 **WARNING**

Do not leave the fryer unattended during use.

 **WARNING**

Use caution when dropping wet food or water into the hot oil. It may cause spattering of the oil, which may cause severe burns

 **WARNING**

Do not overfill the frypot to avoid overflow of hot oil that may cause severe burns, slipping and falling.

 **WARNING**

Use caution and wear appropriate safety equipment when adding oil to the fryer, to prevent splashing of hot oil, which may cause severe burns.

 **WARNING**

Use caution when dropping large amounts of food into the hot oil. It may cause large amounts of foaming, which can overflow and may cause burns.

 **WARNING**

Opening the drain valve will lead to the outflow of the hot contents of the fryer that can cause injury.

 **WARNING**

The OQS (Oil Quality Sensor) may be damaged by the following:

- 1. Incorrect assembly of the filter pan allowing Magnesol or other filter powders under the filter paper.**
- 2. Failure to use filter paper or pads.**
- 3. Torn filter paper or pads.**
- 4. Pumping water, boil out solution or other cleaners through the OQS sensor.**
- 5. Using high pressure to clear the sensor.**

Failure to follow these guidelines may result in high replacement costs and void the warranty.

Table of Contents

Section 1	Introduction.....	1-1
Section 2	Installation.....	2-1
Section 3	Operation Instructions.....	3-1
Section 4	Preventative Maintenance.....	4-1
Section 5	Operator Troubleshooting.....	5-1
Section A	Bulk Oil Instructions.....	A-1
Section B	JIB Preparation with Solid Shortening Option Instructions.....	B-1
Section C	Solid Shortening Melting Unit Use Instructions.....	C-1

FILTERQUICK™ FQE30-T ELECTRIC FRYER

CHAPTER 1: INTRODUCTION

NOTE: The Frymaster FQE30-T fryer requires a start-up, demonstration and training before normal restaurant operations can begin.

1.1 General

Read the instructions in this manual thoroughly before attempting to operate this equipment. This manual covers all configurations of the FQE30-T fryers. The fryers in this model family have most parts in common, and when discussed as a group, will be referred to as FQE30-T fryers.

The FQE30-T fryers feature a low oil volume frypot, top-off (manual or optional auto), automatic filtration and a touch screen. The design incorporates a large round drain which ensures that fries and other debris will be washed into the filter pan. The FQE30-T fryers are controlled with an FQ4000 touchscreen controller. Fryers in this series come in full- or split-vat arrangements, and can be purchased in batteries of up to five vats.

Each frypot is equipped with a temperature probe for precise temperature control.

FQE30-T fryers are shipped completely assembled. All fryers are shipped with a package of standard accessories. Each fryer is adjusted, tested, and inspected at the factory before crating for shipment.

1.2 Safety Information

Before attempting to operate your unit, read the instructions in this manual thoroughly.

Throughout this manual, you will find notations enclosed in double-bordered boxes similar to the one below.

CAUTION

CAUTION boxes contain information about actions or conditions that *may cause or result in a malfunction of your system.*

WARNING

WARNING boxes contain information about actions or conditions that *may cause or result in damage to your system*, and which may cause your system to malfunction.

 **DANGER**

DANGER boxes contain information about actions or conditions that *may cause or result in injury to personnel*, and which may cause damage to your system and/or cause your system to malfunction.

The FQE30-T fryers incorporate a high-temperature detection feature which shuts off power to the elements should the temperature controls fail.

The controller is equipped with a lithium battery. Replace battery with Panasonic CR2032 3V lithium battery, part number 8074674 only. Use of another battery may present a risk of fire or explosion. The battery can be purchased from your Factory Authorized Servicer.

 **CAUTION**

Battery may explode if mistreated. Do not recharge, disassemble or dispose of in fire.

1.3 Information for the FQ4000 Controllers

This equipment has been tested and found to comply with the limits for a Class A digital device, pursuant to Part 15 of the FCC rules. While this device is a verified Class A device, it has been shown to meet the Class B limits. These limits are designed to provide reasonable protection against harmful interference when the equipment is operated in a commercial environment. This equipment generates, uses and can radiate radio frequency energy and, if not installed and used in accordance with the instruction manual, may cause harmful interference to radio communications. Operation of the equipment in a residential area is likely to cause harmful interference in which case the user will be required to correct the interference at their own expense.

The user is cautioned that any changes or modifications not expressly approved by the party responsible for compliance could void the user's authority to operate the equipment.

If necessary, the user should consult the dealer or an experienced radio and television technician for additional suggestions.

The user may find the following booklet prepared by the Federal Communications Commission helpful: "How to Identify and Resolve Radio-TV Interference Problems". This booklet is available from the U.S. Government Printing Office, Washington, DC 20402, Stock No. 004-000-00345-4.

1.4 European Community (CE) Specific Information

The European Community (CE) has established certain specific standards regarding equipment of this type. Whenever a difference exists between CE and non-CE standards, the information or instructions concerned are identified by means of shadowed boxes similar to the one below.

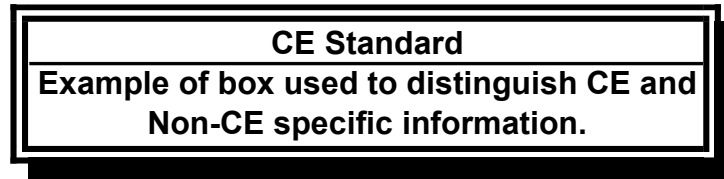

1.5 Installation, Operating, and Service Personnel

Operating information for Frymaster equipment has been prepared for use by qualified and/or authorized personnel only, as defined in Section 1.6. **All installation and service on Frymaster equipment must be performed by qualified, certified, licensed, and/or authorized installation or service personnel, as defined in Section 1.6.**

1.6 Definitions

QUALIFIED AND/OR AUTHORIZED OPERATING PERSONNEL

Qualified/authorized operating personnel are those who have carefully read the information in this manual and have familiarized themselves with the equipment functions, or who have had previous experience with the operation of the equipment covered in this manual.

QUALIFIED INSTALLATION PERSONNEL

Qualified installation personnel are individuals, firms, corporations, and/or companies which, either in person or through a representative, are engaged in and are responsible for the installation of electrical appliances. Qualified personnel must be experienced in such work, be familiar with all electrical precautions involved, and have complied with all requirements of applicable national and local codes.

QUALIFIED SERVICE PERSONNEL

Qualified service personnel are those who are familiar with Frymaster equipment and who have been authorized by Frymaster, L.L.C. to perform service on the equipment. All authorized service personnel are required to be equipped with a complete set of service and parts manuals, and to stock a minimum amount of parts for Frymaster equipment. A list of Frymaster Factory Authorized Servicers (FAS's) is located on the Frymaster website at www.frymaster.com. ***Failure to use qualified service personnel will void the Frymaster warranty on your equipment***

1.7 Shipping Damage Claim Procedure

What to do if your equipment arrives damaged:

Please note that this equipment was carefully inspected and packed by skilled personnel before leaving the factory. The freight company assumes full responsibility for safe delivery upon acceptance of the equipment.

1. **File Claim for Damages Immediately** - regardless of extent of damage.
2. **Inspect For and Record All Visible Loss or Damage**, and ensure that this information is noted on the freight bill or express receipt and is signed by the person making the delivery.
3. **Concealed Loss or Damage**- If damage is unnoticed until equipment is unpacked, notify the freight company or carrier **immediately** upon discovery and file a concealed damage claim. This must be submitted within 5 days of date of delivery. Be sure to retain container for inspection.

***Frymaster* DOES NOT ASSUME RESPONSIBILITY FOR DAMAGE OR LOSS
INCURRED IN TRANSIT.**

1.8 Reading Model Numbers

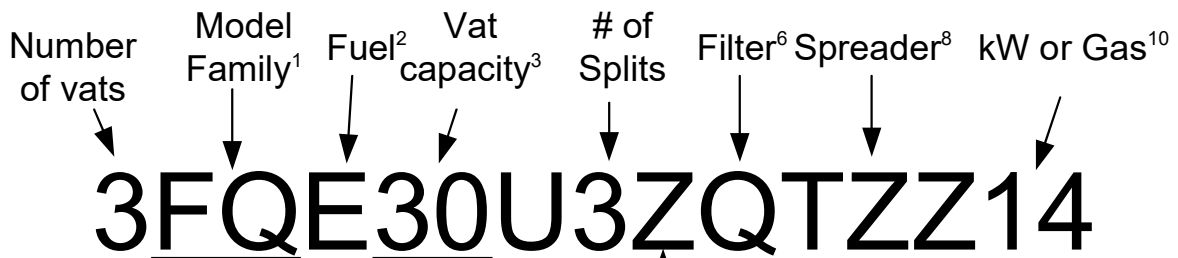

1 = FilterQuick

2 = E-electric or G-gas

3 = 30 lbs

4 = U for open

5 = L-left of filter; R-right of filter; M-Middle; X-Mixed;
Z-all

6 = Q-Semi-Auto w/ ATO

7 = Touch Screen

8 = S-Spreader; Z-none

9 = B-Basket Lift; Z-none

10 = Kilowatts -14, 17, 22kW; Gas-NG (Natural),
PG(Propane), BG(Butane), LG(LPMix)

1.9 Service Information

For non-routine maintenance or repairs, or for service information, contact your local Frymaster Authorized Servicer (FAS). In order to assist you quickly, the Frymaster Authorized Servicer (FAS) or Service Department representative requires certain information about your equipment. Most of this information is printed on a data plate affixed to the inside of the fryer door. Part numbers are found in the Parts Manual. Parts orders may be placed directly with your local FAS or distributor. A list of Frymaster Factory Authorized Servicers (FAS's) is located on the Frymaster website at www.frymaster.com. If you do not have access to this list, contact the Frymaster Service Department at 1-800-551-8633 or 1-318-865-1711 or by email at fryservice@welbilt.com.

The following information will be needed in order to assist you efficiently:

Model Number _____

Serial Number _____

Voltage _____

Nature of the Problem _____

RETAIN AND STORE THIS MANUAL IN A SAFE PLACE FOR FUTURE USE.

FILTERQUICK™ FQE30-T ELECTRIC FRYER

CHAPTER 2: INSTALLATION INSTRUCTIONS

2.1 General Installation Requirements

Proper installation is essential for the safe, efficient, trouble-free operation of this appliance.

Qualified, licensed, and/or authorized installation or service personnel, as defined in Section 1.6 of this manual, should perform all installation and service on Frymaster equipment.

Failure to use qualified, licensed, and/or authorized installation or service personnel (as defined in Section 1.6 of this manual) to install or otherwise service this equipment will void the Frymaster warranty and may result in damage to the equipment or injury to personnel.

Where conflicts exist between instructions and information in this manual and local or national codes or regulations, installation and operation shall comply with the codes or regulations in force in the country in which the equipment is installed.

Service may be obtained by contacting your local Frymaster Authorized Servicer.

 **DANGER**

Building codes prohibit a fryer with its open tank of hot oil being installed beside an open flame of any type, including those of broilers and ranges.

NOTICE

All fryers shipped without factory supplied cords and plug assemblies must be hardwired using flexible conduit to the terminal block located on the rear of the fryer. These fryers should be wired to NEC specifications. Hardwired units must include installation of restraint devices.

 **DANGER**

Adequate means must be provided to limit the movement of this appliance without depending on or transmitting stress to the electrical conduit. A restraint kit is provided with the fryer. If the restraint kit is missing contact your local Frymaster Authorized Servicer (FAS).

NOTICE

If this equipment is wired directly into the electrical power supply, a means for disconnection from the supply having a contact separation of at least 3-mm in all poles must be incorporated in the fixed wiring.

NOTICE

This equipment must be positioned so that the plug is accessible unless other means for disconnection from the power supply (e.g., a circuit breaker) is provided.

NOTICE

If this appliance is permanently connected to fixed wiring, it must be connected by means of copper wires having a temperature rating of not less than 167°F (75°C).

NOTICE

If the electrical power supply cord is damaged, it must be replaced by a Frymaster Authorized Servicer or a similarly qualified person in order to avoid a hazard.

 **DANGER**

This appliance must be connected to a power supply having the same voltage and phase as specified on the rating plate located on the inside of the appliance door.

 **DANGER**

All wiring connections for this appliance must be made in accordance with the wiring diagram(s) furnished with the appliance. Refer to the wiring diagram(s) furnished with the appliance when installing or servicing this equipment.

 **DANGER**

Do not attach an apron drainboard to a single fryer. The fryer may become unstable, tip over, and cause injury. The appliance area must be kept free and clear of combustible material at all times.

In the event of a power failure, the fryer(s) will automatically shut down. If this occurs, turn the power switch OFF. Do not attempt to start the fryer(s) until power is restored.

This appliance must be kept free and clear of combustible material, except that it may be installed on combustible floors.

2.1.1 Clearance and Ventilation

A clearance of 6 inches (15cm) must be provided at both sides and back adjacent to combustible construction. A minimum of 24 inches (61cm) should be provided at the front of the equipment for servicing and proper operation.

 **WARNING**

Do not block the area around the base or under the fryers.

 **DANGER**

No structural material on the fryer should be altered or removed to accommodate placement of the fryer under a hood. Questions? Call the Frymaster Dean Service Hotline at 1-800-551-8633.

When installing any type of fryer, Standard No. 96 of the National Fire Protection Association must be followed implicitly.

The duct system, the hood and filter bank must be cleaned on a regular basis and kept free of grease according to the NFPA Standard No. 96.

A copy of the standard may be obtained from the National Fire Protection Association, Battery March Park, Quincy, MA 02269 or at www.NFPA.org.

2.1.2 Electrical Grounding Requirements

All electrically operated appliances must be grounded in accordance with all applicable national and local codes, and, where applicable, CE codes. In the absence of local codes, the appliance must be grounded in accordance with National Electrical Code, ANSI/NFPA 70, or the Canadian Electrical Code, CSA C22.2, as applicable. All units (cord connected or permanently connected) should be connected to a grounded power supply system. Wiring diagrams are supplied with the fryer. Refer to the rating plate on the inside of the fryer door for proper voltages.

The equipotential grounding lug indicated by illustration (right) allows all the equipment in the same location to be electrically connected to ensure there is no electrical potential difference between the units, which could be hazardous.



⚠ DANGER

This appliance is equipped with a special (grounding) plug for your protection against electrical shock and must be plugged directly into a properly grounded receptacle. Do not cut, remove, or otherwise bypass the grounding prong on this plug!

2.1.3 Australian Requirements

To be installed in accordance with AS 5601 / AG 601, local authority, gas, electricity, and any other relevant statutory regulations.

2.2 Power Requirements

The three-phase supply plug for the elements, controls and filter is rated at 60 amps, 250 VAC and is NEMA configuration L15-60P. Each fryer should have its own individual cord for the element supply on an individual circuit.

VOLTAGE	PHASE	WIRE SERVICE	MIN. SIZE	AWG (mm ²)	AMPS PER LEG		
					L1	L2	L3
208	3	3	6	(16)	39	39	39
240	3	3	6	(16)	34	34	34
480	3	3	8	(10)	17	17	17
220/380	3	4	6	(16)	21	21	21
240/415	3	4	6	(16)	20	20	21
230/400	3	4	6	(16)	21	21	21

NOTICE

If this appliance is permanently connected to fixed wiring, it must be connected by means of copper wires having a temperature rating of not less than 167°F (75°C).

DANGER

This appliance must be connected to a power supply having the same voltage and phase as specified on the rating plate located on the inside of the appliance door.

DANGER

All wiring connections for this appliance must be made in accordance with the wiring diagram(s) furnished with the appliance. Refer to the wiring diagram(s) furnished with the appliance when installing or servicing this equipment.

2.3 After Fryers Are Positioned at the Frying Station

DANGER

No structural material on the fryer should be altered or removed to accommodate placement of the fryer under a hood. Questions? Call the Frymaster Service Hotline at 1-800-551-8633.

1. Once the fryer has been positioned at the frying station, use a carpenter's level placed across the top of the frypot to verify that the unit is level, both side-to-side and front-to-back.

To level fryers, adjust the casters being careful to ensure the fryer(s) are at the proper height in the frying station.

The front right caster may be locked with setscrews that may need to be loosened to move into place. Once in place, the caster setscrews can be locked with the caster wheel parallel to the fryer from front to back to ease moving the fryer in and out of the hood for cleaning and preventing the caster from hitting the oil reservoir.

When the fryer is leveled in its final position, install the restraints provided by the KES to limit its movement so that it does not depend on or transmit stress to the electrical conduit or connection. Install the restraints in accordance with the provided instructions. If the restraints are disconnected for service or other reasons, they must be reconnected before the fryer is used.

DANGER

Adequate means must be provided to limit the movement of this appliance without depending on or transmitting stress to the electrical conduit. A restraint kit is provided with the fryer. If the restraint kit is missing contact your local Frymaster Authorized Servicer (FAS).

⚠ DANGER

Hot oil can cause severe burns. Avoid contact. Under all circumstances, oil must be removed from the fryer before attempting to move it to avoid spills, falls, and severe burns. Fryers may tip and cause personal injury if not secured in a stationary position.

2. Clean and fill frypot(s) to the bottom oil level line with cooking oil. (See *Equipment Setup and Shutdown Procedures* in Chapter 3.)

2.4 Installing the JIB Cradle

Open the fryer door (typically the far-right door or third door) and remove the cross brace used for shipping support by removing the four screws (see Figure 1). Install the JIB cradle shipped (may differ in appearance than one showed) in the accessories pack with the screws that were removed in the cross-brace removal step (see Figure 2). In some configurations the cradle is optional. Install the optional JIB splash shield to protect the bottom of the JIB (see Figure 3). If using the solid shortening option see Appendices A, B, C, D and E in the rear of this manual for installation instructions.



Figure 1

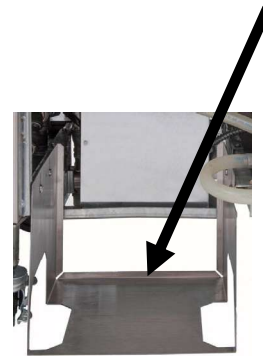

Figure 2

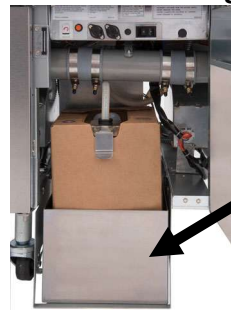
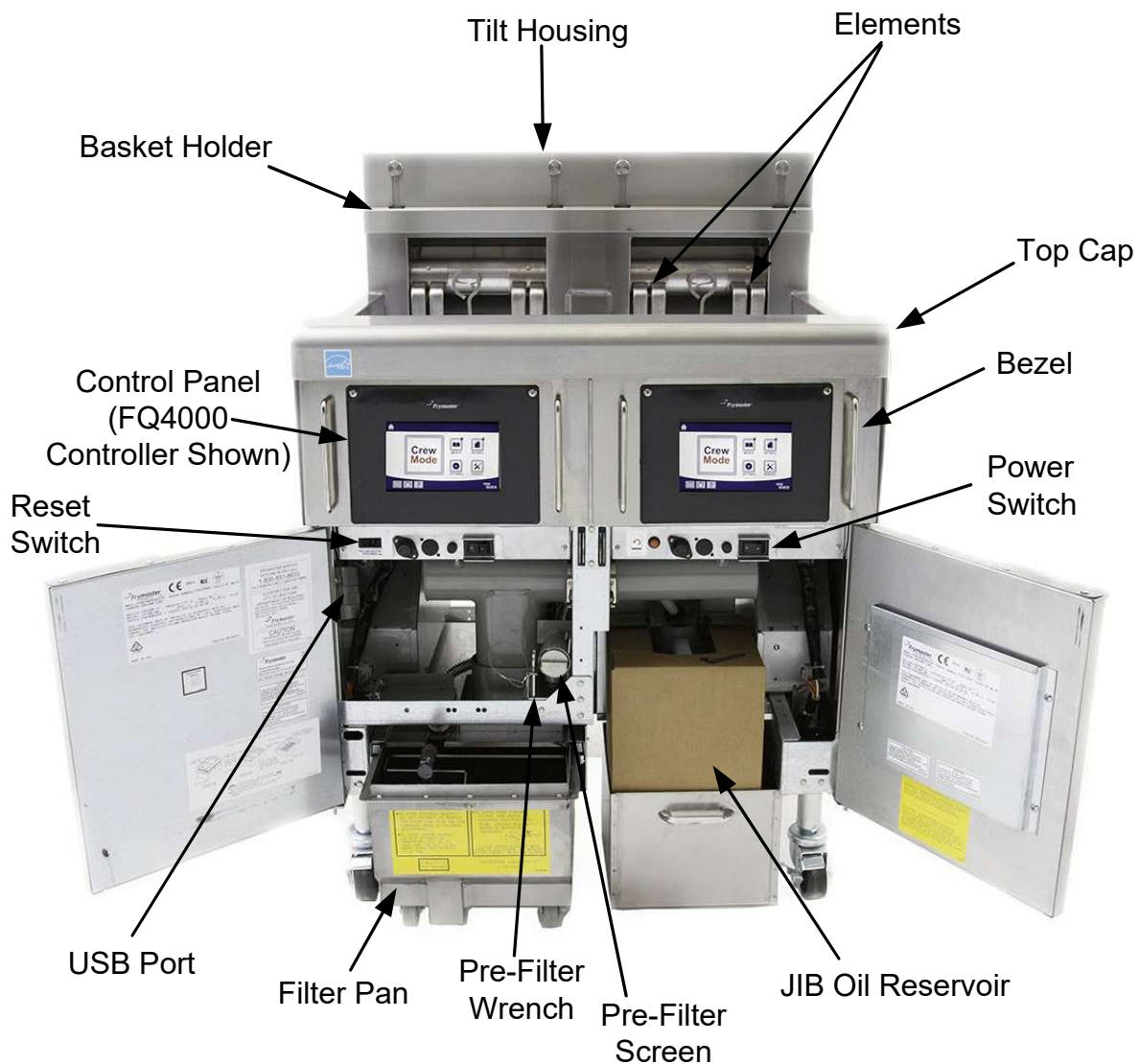

Figure 3

FILTERQUICK™ FQE30-T ELECTRIC FRYER

CHAPTER 3: OPERATING INSTRUCTIONS

FINDING YOUR WAY AROUND THE FQE30-T SERIES ELECTRIC FRYER



TYPICAL CONFIGURATION (2FQE30-T SHOWN)

NOTE: The appearance of your fryer may differ slightly from that shown depending upon configuration and date of manufacture.

3.1 Equipment Setup and Shutdown Procedures

 **WARNING**

The on-site supervisor is responsible for ensuring that operators are made aware of the inherent hazards of operating a hot oil filtering system, particularly the aspects of oil filtration, draining and cleaning procedures.

 **CAUTION**

Before turning on the fryer, ensure there is power to the fryer and the controllers are OFF. Ensure the frypot drain valves are closed. Remove the basket support rack(s), if installed, and fill the frypot to the bottom OIL-LEVEL line. If solid shortening is being used, make sure it is packed down into the bottom of the frypot.

3.1.1 Setup

 **DANGER**

Never operate the appliance with an empty frypot. The frypot must be filled to the bottom OIL-LEVEL line with water or oil before energizing the elements. Failure to do so will result in irreparable damage to the elements and may cause a fire.

 **DANGER**

Remove all drops of water from the frypot before filling with oil. Failure to do so will cause spattering of hot liquid when the oil is heated to cooking temperature.

 **WARNING**

The FQE30-T is not intended to use solid shortening without a solid shortening kit installed. The use of solid shortening without a solid shortening kit will clog the top off oil lines. The oil capacity of the FQE30-T electric fryer is 32 lbs. (3.8 gallons/14.5 liters) at 70°F (21°C) for a full-vat and 18 lbs. (2.2 gallons/8.33 liters) at 70°F (21°C) for each half of a dual-vat.

1. Fill the frypot with cooking oil to the bottom OIL LEVEL line located on the rear of the frypot. This will allow for oil expansion as heat is applied. Do not fill cold oil any higher than the bottom line; overflow may occur as heat expands the oil. For bulk oil systems see Section 2.1.8 of the FQ4000 *Controller Operation Manual 8197474* for instructions to fill the vat from bulk. If solid shortening is used, make sure it is packed down into the bottom of the frypot.
2. Ensure that the power cord(s) is/are plugged and locked (if applicable) into the appropriate receptacle(s). Verify that the face of the plug is flush with the outlet plate, with no portion of the prongs visible.
3. Ensure that the power is switched on with the master switch, located behind the fryer door cabinet on the front panel of the component box, next to the fuse.
4. Ensure that the controller is switched ON. The fryer will automatically enter the melt cycle mode if the frypot temperature is below 180°F (82°C) and will display **MELT CYCLE IN PROGRESS**. (**NOTE:** During the melt cycle, the elements will energize for a few seconds, then go out for a longer period.) The shortening must be stirred occasionally during the heating process to ensure all the shortening in the vat is liquefied. When the frypot temperature

reaches 180°F (82°C), the unit will automatically switch to the heating mode and **PREHEAT** is displayed until within 15°F (9°C) of setpoint. The elements will remain energized until the frypot temperature reaches the programmed cooking temperature. Once the fryer reaches setpoint, the controller display changes to **START** and the fryer is ready for use.

5. Ensure that the oil level is at the *top* OIL LEVEL line when the oil *is at its cooking temperature*.
6. The maximum batch load for French Fries in oil or fat shall be no more than 1½ pounds or 0.7 kilograms.

Shutdown

1. Place the controller ON/OFF switch in the OFF position to turn the fryer off.
2. Filter the oil and clean the fryers (See Chapters 1 and 2 of the *FQ4000 Controller Operation Manual*).
3. Clean the filter pan and replace the filter paper or pad. Do not leave solid shortening in the filter pan over night.
4. Place the frypot covers on the frypots.

3.2 Operation

This fryer is equipped with FQ4000 controllers (illustrated right). Refer to the *FQ4000 Controller Operation Manual 819-7474* for the controller programming, operating procedures and for operating instructions for the built-in filtration system.



FQ4000 CONTROLLER

3.3 Manual Top-Off, Automatic Top-Off and JIB Refill

The fryer can be configured for either manual top off or for both manual and automatic depending on the hardware. When a vat is low, press the manual top off (oil drop) button at the bottom of the screen (see Figure 3) to top off the vat. The controller displays **PUSH BUTTON TOP OFF?** Press the **YES (√)** button. **START FILLING?** is displayed. Press and hold the button to start filling. Release the button when the oil is at the top oil level line. Press the **NO (X)** button to exit. If the unit has optional auto top off, the frypot oil levels are continually checked and topped off as necessary from a reservoir in the cabinet.

The top off reservoir holds a 35-pound box of oil. In a typical operation this will last approximately two days.

Components of the system are annotated at the right (see Figure 1).

NOTE: The frypots will require manual filling upon startup and after a clean (boil-out or cold clean) unless a bulk fresh oil system is used.

JIB (Jug In Box) Low Reset Switch: Resets the ATO system after oil change.

Special Cap: Has plumbing attached to draw oil from the reservoir to the fryer vats.

Jug In Box (JIB): The JIB is the reservoir for the oil.



Figure 1

3.3.1 Install the oil reservoir or jug (JIB)

Remove the original lid from the oil container and foil liner. Replace with the provided cap, which has connected suction hardware. Ensure the feeder tube from the cap reaches to the bottom of the oil container.

Place the oil container inside the cabinet and slide it into place (as shown on the following page). Avoid catching the suction hardware on the cabinet interior as the container is placed in the fryer. The system is now ready for operation.

3.3.2 Changing the JIB (Jug In Box) oil reservoir

When the oil reservoir level is low and displays TOP OFF OIL EMPTY, (see Figure 2). Press the check button to clear the screen. Once the reservoir is refilled and/or replaced, press and hold the orange reset button next to the oil reservoir (see Figure 7 on the following page) until the message in the lower corner is no longer displayed. If using solid shortening, see Appendix B for instructions.

1. Open the cabinet and slide the JIB from the cabinet (see Figure 3).



Figure 3

3. With the replacement jug upright remove the cap and foil seal (see Figure 5).



Figure 5

2. Remove the cap and pour any remaining oil in the container into all fry vats equally (see Figure 4).



Figure 4

4. Put the tube in the new full container (see Figure 6).



Figure 6

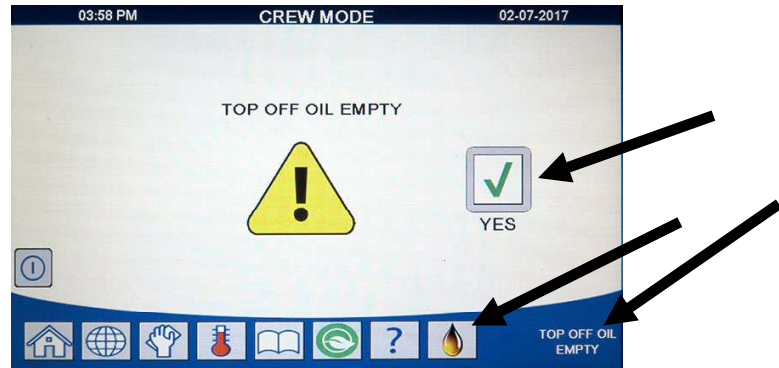

Figure 2

Top Off Oil Empty indicates that the oil reservoir is empty.

⚠ WARNING
Do not add HOT or USED oil to a JIB.

5. Slide the JIB onto the shelf inside the fryer cabinet (as seen in Figure 3).
6. Press the JIB reset switch to clear the Top Off Empty display on the FQ4000 controller off (see Figure 7).



Figure 7

3.3.3 Bulk Oil Systems

Instructions for installing and using bulk oil systems are found in Appendix A located at the rear of this manual.

3.4 Filtration

3.4.1 Introduction

The FilterQuick™ with fingertip filtration system allows the oil in one frypot to be safely and efficiently filtered while the other frypots in a battery remain in operation.

Section 3.4.2 covers preparation of the filter system for use. Operation of the system is covered in the FilterQuick Touch Controller Manual.

⚠ WARNING
The on-site supervisor is responsible for ensuring that operators are made aware of the inherent hazards of operating a hot oil filtering system, particularly the aspects of oil filtration, draining and cleaning procedures.

⚠ DANGER
When using a sediment basket, it **MUST** be removed and emptied prior and during each filtration. Some food particles can spontaneously combust if left soaking in certain shortening material.

⚠ DANGER
The crumb tray in fryers equipped with a filter system **MUST** be emptied into a fireproof container at the end of frying operations each day. Some food particles can spontaneously combust if left soaking in certain shortening material.

⚠ WARNING
The filter pad or paper **MUST** be replaced daily or when the sediment level exceeds the height of the hold down ring.

3.4.2 Preparing the FilterQuick™ with FQ4000 Filtration System for Use with Filter Paper or Filter Pad

The FilterQuick™ filtration system uses a filter paper configuration which includes a crumb tray, large hold-down ring, and metal filter screen.

1. Pull the filter pan out from the cabinet and remove the crumb tray, hold-down ring, filter paper and filter screen (see Figure 8). Clean all components with a solution of detergent and hot water then dry thoroughly.

The pan cover must not be removed except for cleaning, interior access, or to allow a shortening disposal unit (SDU) built before January 2004 to be positioned under the drain. Disposal instructions are in the FQ4000 controller manual.

2. Inspect the filter pan connection fitting to ensure that both O-rings are in good condition (see Figure 9).

3. Then in reverse order, place the metal filter screen in the center of the bottom of the pan, then lay a sheet of filter paper on top of the screen, overlapping on all sides (see Figure 11). If using a filter pad, ensure the rough side of the pad is up and lay the pad over the screen, making sure that the pad is in between the embossed ridges of the filter pan.

4. Position the hold-down ring over the filter paper and lower the ring into the pan, allowing the paper to rest on the sides of the filter pan (see Figure 10).

5. When the hold-down ring is in position, sprinkle one packet of filter powder evenly over the paper. (See Figure 11).

6. Replace the crumb tray in the filter pan, then push the filter pan back into the fryer, positioning it under the drain.

DO NOT USE FILTER POWDER WITH THE PAD!

7. Push the filter pan back into the fryer, positioning it under the fryer. Ensure “P” is NOT displayed on the controller. The filtration system is now ready for use.

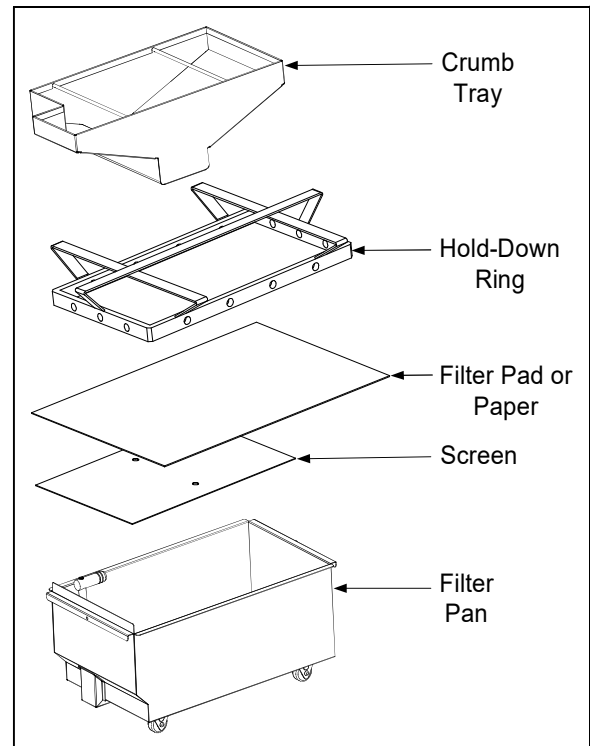
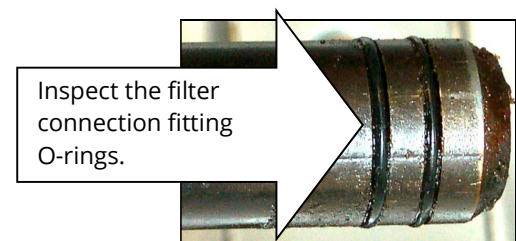

Figure 8



Inspect the filter connection fitting O-rings.

Figure 9



Figure 10



Figure 11

 DANGER

Do not drain more than one frypot at a time into the built-in filtration unit to avoid overflow and spillage of hot oil that may cause severe burns, slipping and falling.

 DANGER

The crumb tray in fryers equipped with a filter system must be emptied into a fireproof container at the end of frying operations each day. Some food particles can spontaneously combust if left soaking in certain shortening material.

 WARNING

Do not bang fry baskets or other utensils on the fryer's joiner strip. The strip is present to seal the joint between the fry vessels. Banging fry baskets on the strip to dislodge shortening will distort the strip, adversely affecting its fit. It is designed for a tight fit and should only be removed for cleaning.

FILTERQUICK™ FQE30-T ELECTRIC FRYER

CHAPTER 4: PREVENTATIVE MAINTENANCE

4.1 Fryer Preventive Maintenance Checks and Service

 **DANGER**

The crumb tray in fryers equipped with a filter system must be emptied into a fireproof container at the end of frying operations each day. Some food particles can spontaneously combust if left soaking in certain shortening material.

 **DANGER**

When using a sediment basket, it **MUST** be removed and emptied prior and during each filtration. Some food particles can spontaneously combust if left soaking in certain shortening material.

 **DANGER**

Never attempt to clean the fryer during the frying process or when the frypot is filled with hot oil. If water comes in contact with oil heated to frying temperature, it will cause spattering of the oil, which can result in severe burns to nearby personnel.

 **WARNING**

Use multi-purpose detergent. Read the directions for use and precautionary statements before use. Particular attention must be paid to the concentration of cleaner and the length of time the cleaner remains on the food contact surfaces.

4.2 DAILY CHECKS AND SERVICE

4.2.1 Inspect Fryer and Accessories for Damage

Look for loose or frayed wires and cords, leaks, foreign material in frypot or inside cabinet, and any other indications that the fryer and accessories are not ready and safe for operation.

4.2.2 Clean Inside and Outside of the Fryer Cabinet - Daily

Clean inside the fryer cabinet with a dry, clean cloth. Wipe all accessible metal surfaces and components to remove accumulated oil and dust.

Clean the outside of the fryer cabinet with a clean, damp cloth soaked with a multi-purpose detergent, removing oil, dust, and lint from the fryer cabinet. Wipe with a clean, damp cloth.

4.2.3 Clean the Built-In Filtration System - Daily

 **WARNING**

Never operate the filter system without oil in the system.

⚠ WARNING

Never use the filter pan to transport old oil to the disposal area.

⚠ WARNING

Never drain water into the filter pan. Water will damage the filter pump.

There are no periodic preventive maintenance checks and services required for your filtration system other than daily cleaning of the filter pan with a solution of hot water and a multi-purpose detergent.

If you notice that the system is pumping slowly or not at all, verify that the filter pan screen is on the bottom of the filter pan, with the paper or pad on top of the screen. Verify that the two O-ring(s) on the fitting at the right front of the filter pan are present and in good condition. Verify that the pre-filter is clean and tightened with the wrench.

4.2.4 Clean Filter Pan, Detachable Parts and Accessories - Daily

As with the frypot, a deposit of carbonized oil will accumulate on the filter pan and detachable parts and accessories such as baskets, sediment trays, or fishplates.

Wipe the filter pan and all detachable parts and accessories with a clean dry cloth. Use a cloth dampened with a solution of a multi-purpose detergent. To remove accumulated carbonized oil. Rinse and thoroughly dry each part. DO NOT use steel wool or abrasive pads to clean these parts. The scratches that result from such scrubbing make subsequent cleanings more difficult.

4.2.5 Clean around AIF and ATO sensors - Daily

1. Clean the sediment from around the AIF and ATO sensors during clean and filter when the oil is drained from the frypot.
2. Use a brush or other similar object which allows access around the probe (see photo right). Use caution to ensure that the probe is not damaged. Frymaster recommends brush kit PN 8263841.
3. Return the oil once the clean and filter is complete.



4.2.6 Clean Basket Lift Rods - Daily

On fryers equipped with basket lifts, wipe down the rods with dry, clean cloth to remove accumulations of oil and dust.

4.3 WEEKLY CHECKS AND SERVICE

4.3.1 Clean Behind Fryers - Weekly

Clean behind fryers in accordance with store procedures. Shut the fryer off and disconnect power.

4.4 MONTHLY CHECKS AND SERVICE

4.4.1 Deep Cleaning (Boiling Out/Cold Clean) the Frypot – Minimally Monthly

DANGER

Never operate the appliance with an empty frypot. The frypot must be filled to the fill line with water or cooking oil before energizing the elements. Failure to do so will result in irreparable damage to the elements and may cause a fire.

During normal usage of your fryer, a deposit of carbonized oil will gradually form on the inside of the frypot. This film should be periodically removed by following the Clean (boil-out) procedure. Refer to sections 2.3.10 and 2.3.11 of the FQ4000 Controller Operation Manual) for specific details on setting up the controller for clean (boil-out) operation.

DANGER

Allow oil to cool to 100°F (38°C) or lower before draining to an appropriate container for disposal.

WARNING

Never leave the fryer unattended during this process. If the solution overflows, press the ON/OFF switch to the OFF position immediately.

DANGER

Ensure that the frypot is completely free of water before filling with oil. When the oil is heated to cooking temperature, water in the frypot will cause splattering.

4.4.2 Pre-filter Maintenance - Monthly

The pre-filter requires regular maintenance. Every 30 days, or more frequently if the flow of oil slows, remove the cap and clean

DANGER

Wear protective gloves when removing the pre-filter. The filter may be hot and cause severe burns.



Figure 2



Figure 3

the attached screen.

1. **Wearing protective gloves** use the supplied wrench to remove the cap from the pre-filter (Figure 2).
2. Use a small brush to clear debris from the attached screen (Figure 3).
3. Clean under a water tap and thoroughly dry.
4. Return the cap to the pre-filter housing and **tighten with the attached wrench**, ensuring the pre-filter is tight. If the cap is not tight, air will leak around the pre-filter and slow the return.

WARNING

DO NOT remove the pre-filter cap when a filter cycle is under way.
DO NOT operate the filter system with the cap removed. Wear protective gloves when handling the cap. The metal and the exposed oil are hot.

4.4.3 Check FQ4000 Controller Set Point Accuracy - Monthly

1. Insert a good-grade thermometer or pyrometer probe into the oil, with the end touching the fryer temperature-sensing probe.
2. When the controller product icons are visible (indicating that the frypot contents are within the cooking range), press the  button once to display the temperature and setpoint of the oil as sensed by the temperature probe.
3. Note the temperature on the thermometer or pyrometer. Actual temperature and pyrometer readings should be within $\pm 5^{\circ}\text{F}$ (3°C) of each other after allowing the heat to cycle on and off three (3) times. If the temperature is still out of tolerance, contact a Factory Authorized Servicer for assistance.

4.5 QUARTERLY CHECKS AND SERVICE

4.5.1 Replace the O-rings - Quarterly

Replace the O-rings on the filter connection (see Figure 10 in section 3.4.2).

4.6 ANNUAL/PERIODIC SYSTEM INSPECTION

This appliance should be inspected and adjusted periodically by qualified service personnel as part of a regular kitchen maintenance program.

Frymaster recommends that a Factory Authorized Servicer inspect this appliance at least annually as follows:

4.6.1 Fryer - Annual

- Inspect the cabinet inside and out, front and rear for excess oil.
- Verify that the heating element wires are in good condition and that leads have no visible fraying or insulation damage and that they are free of oil.
- Verify that heating elements are in good condition with no carbon/caramelized oil build-up. Inspect the elements for signs of extensive dry-firing.
- Verify that the tilt mechanism is working properly when lifting and lowering elements and that the element wires are not binding and/or chafing.
- Verify the heating-element amp-draw is within the allowed range as indicated on the appliance's rating plate.
- Verify that the temperature and high-limit probes are properly connected, tightened and functioning properly, and that mounting hardware and probe guards are present and properly installed.
- Verify that component box and contactor box components (i.e. computer/controller, relays, interface boards, transformers, contactors, etc.) are in good condition and free from oil and other debris.
- Verify that component box and contactor box wiring connections are tight and that wiring is in good condition.

- Verify that all safety features (i.e. contactor shields, reset switches, etc.) are present and functioning properly.
- Verify that the frypot is in good condition and free of leaks and that the frypot insulation is in serviceable condition.
- Verify that all wiring harnesses and connections are tight and in good condition.

4.6.2 Built-In Filtration System - Annual

- Inspect all oil-return and drain lines for leaks and verify that all connections are tight.
- Inspect the filter pan for leaks and cleanliness. If there is a large accumulation of crumbs in the crumb basket, advise the owner/operator that the crumb basket should be emptied into a fireproof container and cleaned daily.
- Verify that all O-rings and seals are present and in good condition. Replace O-rings and seals if worn or damaged.
- Check filtration system integrity as follows:
 - Verify that filter pan cover is present and properly installed.
 - With the filter pan empty, place each vat into fill vat from filter pan selection (see section 2.3.7 of the *FQ4000 Controller Operation Manual*), one at a time. Verify proper functioning of each oil return valve by activating the filter pump using the fill vat from drain pan selection. Verify that the pump activates and that bubbles appear in the cooking oil of the associated frypot.
 - Verify that the filter pan is properly prepared for filtering, then drain a frypot of oil heated to 350°F (177°C) into the filter pan by using the drain to pan selection (see section 2.3.6 of the *FQ4000 Controller Operation Manual*). Now using the fill vat from pan drain pan selection (see section 2.3.7 of the *FQ4000 Controller Operation Manual*), allow all oil to return to the frypot (indicated by bubbles in the cooking oil). Press the check button when all oil is returned. The frypot should have refilled in approximately 2 minutes and 30 seconds.

FILTERQUICK™ FQE30-T ELECTRIC FRYER

CHAPTER 5: OPERATOR TROUBLESHOOTING

5.1 Introduction

This section provides an easy reference guide to some of the common problems that may occur during the operation of this equipment. The troubleshooting guides that follow are intended to help correct, or at least accurately diagnose, problems with this equipment. Although the chapter covers the most common problems reported, you may encounter problems that are not covered. In such instances, the Frymaster Technical Services staff will make every effort to help you identify and resolve the problem.

When troubleshooting a problem, always use a process of elimination starting with the simplest solution and working through to the most complex. Never overlook the obvious – anyone can forget to plug in a cord or fail to close a valve completely. Most importantly, always try to establish a clear idea of why a problem has occurred. Part of any corrective action involves taking steps to ensure that it doesn't happen again. If a controller malfunctions because of a poor connection, check all other connections, too. If a fuse continues to blow, find out why. Always keep in mind that failure of a small component may often be indicative of potential failure or incorrect functioning of a more important component or system.

Before calling a service agent or the Frymaster HOTLINE (1-800-24-FRYER):

- **Verify that electrical cords are plugged in and that circuit breakers are on.**
- **Have your fryer's model and serial numbers ready to give to the technician assisting you.**

 **DANGER**

Hot oil will cause severe burns. Never attempt to move this appliance when filled with hot oil or to transfer hot oil from one container to another.

 **DANGER**

This equipment should be unplugged when servicing, except when electrical circuit tests are required. Use extreme care when performing such tests.

This appliance may have more than one electrical power supply connection point. Disconnect all power cords before servicing.

Inspection, testing, and repair of electrical components should be performed by an authorized service agent only.

5.2 Troubleshooting

5.2.1 Controller and Heating Problems

Problem	Probable Causes	Corrective Action
No display on the controller.	A. No power to fryer. B. Failed controller or other component	A. Verify that the fryer is plugged in and that the circuit breaker is not tripped. B. Call your FAS for assistance.
FQ4000 displays IS VAT FULL? YES NO after a filtration.	A. Normal operation during most at the beginning or end of most filtration functions. B. If the display appears many times during a filter it could be an indication of slow oil return.	A. Ensure the vat is full of oil and press the √ button. B. See section 5.3 troubleshooting –Filter Pump runs, but oil return is very slow.
FQ4000 displays IS DRAIN CLEAR?	Drain is clogged and oil failed to drain.	Clear drain with Fryers Friend and press √ button. Filtration will resume.
FQ4000 displays CHANGE FILTER PAD?	Filter error has occurred, filter pad clogged, 25-hour filter pad change prompt has occurred or change filter pad was ignored on a prior prompt.	Change the filter pad and ensure the filter pan has been removed from the fryer for a minimum of 30 seconds. Do NOT ignore CHANGE FILTER PAD prompts.
Fryer does not heat.	A. Power cord(s) not plugged in.	A. Verify that all the power cord(s) are fully seated in their receptacle(s), locked into place and that circuit breaker is not tripped
	B. Controller or other components have failed.	B. Call your FAS for assistance.
Fryer heats until high-limit trips with heat indicator ON.	Temperature probe or controller has failed.	Call your FAS for assistance.
Fryer heats until high-limit trips without heat indicator ON.	Contact or controller has failed	Call your FAS for assistance.
FQ4000 displays MISCONFIGURED ENERGY TYPE	Energy type in fryer setup is incorrect.	Ensure that the fryer is configured properly for the correct energy type.
FQ4000 displays VAT ID CONNECTOR NOT CONNECTED	Controller locator missing or disconnected.	Ensure the 6-pin locator is connected to rear of controller and it properly grounded in control box.
Controller locks up.	Controller error.	Remove and restore power to the controller. If problem persists, call your FAS for assistance.

5.2.2 Error Messages and Display Problems

Problem	Probable Causes	Corrective Action
FQ4000 displays E19 HEATING FAILURE.	Failed controller, failed transformer, failed SIB board, open high-limit thermostat.	Call your FAS for assistance.
FQ4000 display is in wrong temperature scale (Fahrenheit or Celsius).	Incorrect display option programmed.	Toggle between F° to C° by entering Manager settings, temperature and toggling the temperature scale. Turn the controller on to check temperature. If the desired scale is not displayed, repeat.
FQ4000 displays HOT-HI-1.	Frypot temperature is more than 410°F (210°C) or, in CE countries, 395°F (202°C).	Shut the fryer down immediately and call your FAS for assistance.
FQ4000 displays HELP HI-2 or HIGH LIMIT FAILURE DISCONNECT POWER.	Failed high limit	Disconnect power from the entire fryer immediately and call your FAS for assistance.
FQ4000 displays TEMPERATURE PROBE FAILURE.	Problem with the temperature measuring circuitry including the probe or damaged controller wiring harness or connector.	Shut the fryer down and call your FAS for assistance.
Heating indicator is on, but fryer is not heating.	Three phase power cord unplugged or circuit breaker is tripped.	Verify that all power cord(s) are fully seated in their receptacle(s), locked into place and that circuit breaker is not tripped. If the problem continues call your FAS for assistance.
FQ4000 displays RECOVERY FAULT and alarm sounds.	Recovery time exceeded maximum time limit.	Clear error and silence the alarm by pressing the √ button. Maximum recovery time for electric is 1:40. If this error continues call your FAS for assistance.
FQ4000 displays NO MENU GROUP AVAILABLE FOR SELECTION	All menu groups have been deleted.	Create a new MENU group. Once a new menu is created, add recipes to the group (see section 1.10 of the FQ4000 controller manual).
FQ4000 displays SERVICE REQUIRED followed by an error message.	An error has occurred which requires a service technician.	Press X to continue cooking and call your FAS for assistance. In some cases, cooking may not be available.



5.3 Troubleshooting the Auto Filtration



Problem	Probable Causes	Corrective Action
Fryer filters after each cook cycle.	Filter after setting incorrect.	Change or overwrite the filter after setting by re-entering the filter after value in Manager Settings, Filter Attributes in section 1.8 of the FQ4000 controller manual.
Clean and Filter won't start.	Temperature too low.	Ensure fryer is at setpoint before starting a Clean and Filter.
FQ4000 display shows FILTER BUSY.	<ul style="list-style-type: none"> A. Another filtration cycle or filter pad change is still in process. B. Filter interface board has not cleared checking system. 	<ul style="list-style-type: none"> A. Wait until the previous filtration cycle ends to start another filtration cycle. Change filter pad if prompted. B. Wait 15 minutes and try again.
Filter pump won't start or pump stops during filtering.	<ul style="list-style-type: none"> A. Power cord is not plugged in or circuit breaker is tripped. B. Pump motor has overheated causing the thermal overload switch to trip. C. Blockage in filter pump. 	<ul style="list-style-type: none"> A. Verify that the power cord is fully plugged in and the circuit breaker is not tripped. B. If the motor is too hot to touch for more than a few seconds, the thermal overload switch has probably tripped. Allow the motor to cool at least 45 minutes then press the Pump Reset Switch (see section 2.1.2 of the FQ4000 controller manual). C. Call your FAS for assistance.
Drain valve or return valve stays open.	<ul style="list-style-type: none"> A. VIB board has failed. B. Actuator has failed. 	Call your FAS for assistance.
FQ4000 display shows INSERT pan.	<ul style="list-style-type: none"> A. Filter pan is not fully set into fryer. B. Missing filter pan magnet. C. Defective filter pan switch. 	<ul style="list-style-type: none"> A. Pull filter pan out and fully reinsert into fryer. Ensure controller does not display P. B. Ensure the filter pan magnet is in place and replace if missing. C. If the filter pan magnet is fully against the switch and controller continues to display INSERT PAN, switch is possibly defective.

Problem	Probable Causes	Corrective Action
Auto filtration, OQS filter won't start.	<ul style="list-style-type: none"> A. Oil level too low. B. Oil temperature is too low. C. Filter Pan out. D. Filtration in recipe settings is set to OFF. E. Filter relay has failed. 	<ul style="list-style-type: none"> A. Ensure oil level is at the top oil fill line (at the top oil level sensor). B. Ensure the oil temperature is at setpoint. C. Ensure controller does not display P. Ensure the filter pan is fully seated into fryer. Power cycle the fryer. D. Set filtration in recipes to ON. E. Call your FAS for assistance.
Filter Pump runs, but oil return is very slow.	<ul style="list-style-type: none"> A. Clogged filter pad/paper. B. Improperly installed or prepared filter pan components. C. Pre-filter screen may be clogged or not fully tightened. 	<ul style="list-style-type: none"> A. Ensure the filter is not clogged. If so replace the filter. B. Remove the oil from the filter pan and replace the filter pad/paper, ensuring that the filter screen is in place under the pad/paper. Verify, if using a pad, that the rough side is facing up. Verify that O-rings are present and in good condition on filter pan connection fitting. C. Clean pre-filter (see section 4.5.4) and ensure it is tightened with the attached wrench.

5.3.1 Incomplete Filtration

Should the auto filtration procedure fail an error message is generated. Follow the instructions on the screen to return the oil and clear the error.

DISPLAY	ACTION
IS VAT FULL?	1. Press the √ (check) button if the vat is full to continue. The controller returns to idle cook mode or  . Press X if vat is not filled completely.
FILLING IN PROGRESS	2. No action required as the pump runs.
IS VAT FULL?	3. Press the √ (check) button if the vat is full to continue. The controller returns to idle cook mode or  . Press X if vat is not filled completely.
FILLING IN PROGRESS	4. No action required as the pump runs.
IS VAT FULL?	5. Press the √ (check) button if the vat is full to continue. The controller returns to idle cook mode or  . Press X if vat is not filled completely. If this is the sixth consecutive sequence of incomplete filtration skip to step 10.

CHANGE FILTER PAPER?	6. Press the √ (check) button to continue. Pressing X advances to  .
REMOVE PAN	7. Remove the filter pan.
CHANGE FILTER PAPER	8. Change the filter paper/pad and ensure the filter pan has been pulled forward, out of the cabinet for at least 30 seconds. Once the pan has been out for 30 seconds the controller returns to idle cook mode. Ensure the pan is dry and assembled correctly. Push the filter pan back into the fryer. Ensure “P” is not displayed on the controller.
IS VAT FULL?	9. Press the √ (check) button if the vat is full to continue. The controller returns to idle cook mode. Press X if vat is not full and the controller advances to  .
SERVICE REQUIRED	10. If a filtration error occurs six consecutive times, the return valve closes. Press the √ (check) button to silence alarm and continue.
ERROR PUMP NOT FILLING	11. The system detects oil is not returning to the vat and service is required. Call your FAS.
SYSTEM ERROR FIXED?	12. Press the X button to continue cooking if possible. Call your FAS to repair and reset the fryer. The error will be re-displayed every 15 minutes until the issue is repaired. Auto filtration and auto top off are disabled until the fryer is reset.
ENTER CODE	13. FAS tech enters tech code to reset fryer.
FILL VAT FROM DRAIN PAN?	14. Press the √ (check) button to fill the vat from filter pan to continue. Follow prompts once the vat is full. Press X to skip filling from drain pan.
REMOVE PAN	15. Remove the filter pan.
IS PAN EMPTY?	16. Press the √ (check) button if the filter pan is empty and continue to next step. Press X to continue filling the vat. Follow the prompts once the vat is full.
	17. The controller switches off.

5.3.2 Clogged Drain Error

The clogged drain error occurs during auto filtration when the oil level sensor detects that oil has not completely drained from the frypot. This may be due to a clogged drain or an oil sensor failure. Follow the instructions on the controller display to clear the error.

When this occurs the controller displays **CLEAR DRAIN** for 15 seconds changing to **IS DRAIN CLEAR?**

1. Clear debris from the drain using the fryer’s friend and press the √ button to continue.
2. The controller displays **DRAINING**. Once the oil level sensor detects the oil has drained, normal auto filtration operation resumes.

5.3.3 Filter Busy

When **FILTER BUSY** is displayed the filter interface board is waiting on another vat to be filtered or waiting on another function to finish. Wait 15 minutes to see if problem is corrected. If not, call your local FAS.

5.4 Troubleshooting Auto Top Off Issues

PROBLEM	PROBABLE CAUSES	CORRECTIVE ACTION
Frypots top off cold.	Incorrect setpoint.	Ensure setpoint is correct.
One vat doesn't top off.	<ul style="list-style-type: none"> A. Filter error exists. B. Service required error exists C. Solenoid, pump, pin issue, RTD or ATO issue. 	<ul style="list-style-type: none"> A. Clear filter error properly. If problem persists call your FAS for assistance. B. Call your FAS for assistance. C. Call your FAS for assistance.
Frypots won't top off.	<ul style="list-style-type: none"> A. Fryer temperature too low. B. Oil is too cold. C. Top oil empty displayed D. Service required error exists E. Melting unit switch is off (only on solid shortening units) F. Blown fuse. 	<ul style="list-style-type: none"> A. Fryer temperature must be at setpoint. B. Ensure that the oil in the top off reservoir is above 70°F (21°C). C. Ensure the top off reservoir is not out of oil. Replace top off reservoir or fill from bulk and reset top off system. If problem persists call your FAS for assistance. D. Call your FAS for assistance. E. Ensure the switch on the melting unit is in the ON position. F. Check the fuse on the left of the ATO box. If using a solid shortening melting unit, check the fuse below the melting unit switch.

5.5 Troubleshooting Bulk Oil System Problems

PROBLEM	PROBABLE CAUSES	CORRECTIVE ACTION
Frypot won't fill.	<ul style="list-style-type: none"> A. Incorrect setup procedure. B. Dispose valve not completely closed. C. Bulk oil tank is empty. D. RTI pump issue. 	<ul style="list-style-type: none"> A. Power cycle fryer by disconnecting and reconnecting the bulk oil control connector on rear of fryer. B. Ensure the dispose valve handle is pushed fully closed. C. Call your bulk oil provider. D. Call you FAS for assistance.

PROBLEM	PROBABLE CAUSES	CORRECTIVE ACTION
Top off reservoir won't fill.	<ul style="list-style-type: none"> A. Incorrect setup procedure. B. Another function is in process. C. Dispose valve not completely closed. D. Bulk oil tank is empty. E. Solenoid, pump or switch issue. 	<ul style="list-style-type: none"> A. Power cycle fryer by disconnecting and reconnecting 5-pin bulk oil control power cord on rear of fryer. B. If a filtration or any other filter menu function is in process or FILTER NOW? YES/NO, CONFIRM YES/NO, or SKIM VAT are displayed, wait until the process is complete and try again. C. Ensure the dispose valve handle is pushed fully closed. D. Call your bulk oil provider. E. Call you FAS for assistance.
Top off reservoir or vat filling slow.	<ul style="list-style-type: none"> A. Pump or line issues beyond the scope of operator troubleshooting. 	<ul style="list-style-type: none"> A. Contact your bulk oil provider.

5.6 Error Log Codes

See section 1.13.2.1 in the FQ4000 controller manual for instructions to access the Error Log.

Code	ERROR MESSAGE	EXPLANATION
E13	TEMPERATURE PROBE FAILURE	TEMP Probe reading out of range
E16	HIGH LIMIT 1 EXCEEDED	High limit temperature is past more than 410°F (210°C), or in CE countries, 395°F (202°C)
E17	HIGH LIMIT 2 EXCEEDED	High limit switch has opened.
E18	HIGH LIMIT PROBLEM DISCONNECT POWER	Vat temperature exceeds 460°F (238°C) and the high limit has failed to open. Immediately disconnect power to the fryer and call service.
E19	HEATING FAILURE - XXX F or XXX C	Heating Control latch circuit failed. Heat Contactor failed to latch.
E25	HEATING FAILURE - BLOWER	The air pressure switch(s) failed to close.
E27	HEATING FAILURE - PRESSURE SWITCH - CALL SERVICE	The air pressure switch has failed closed.
E28	HEATING FAILURE - XXX F or XXX C	The fryer has failed to ignite and has locked out the ignition module.
E29	TOP OFF PROBE FAILURE - CALL SERVICE	ATO RTD reading out of range
E32	DRAIN VALVE NOT OPEN - FILTRATION AND TOP OFF DISABLED - CALL SERVICE	Drain valve was trying to open and confirmation is missing
E33	DRAIN VALVE NOT CLOSED - FILTRATION AND TOP OFF DISABLED - CALL SERVICE	Drain valve was trying to close and confirmation is missing
E34	RETURN VALVE NOT OPEN - FILTRATION AND TOP OFF DISABLED - CALL SERVICE	Return valve was trying to open and confirmation is missing
E35	RETURN VALVE NOT CLOSED - FILTRATION AND TOP OFF DISABLED - CALL SERVICE	Return valve was trying to close and confirmation is missing

Code	ERROR MESSAGE	EXPLANATION
E36	VALVE INTERFACE BOARD FAILURE - FILTRATION AND TOP OFF DISABLED - CALL SERVICE	Valve Interface Board connections lost or board failure.
E37	AUTOMATIC INTERMITTENT FILTRATION PROBE FAILURE - FILTRATION DISABLED - CALL SERVICE	AIF RTD reading out of range.
E39	CHANGE FILTER PAD	25-hour timer has expired or dirty filter logic has activated.
E41	OIL IN PAN ERROR	The system detects that oil may be present in the filter pan.
E42	CLOGGED DRAIN (Gas)	Vat did not empty during filtration
E43	OIL SENSOR FAILURE - CALL SERVICE	Oil level sensor may have failed.
E44	RECOVERY FAULT	Recovery time exceeded maximum time limit.
E45	RECOVERY FAULT - CALL SERVICE	Recovery time exceeded maximum time limit for two or more cycles.
E46	SYSTEM INTERFACE BOARD 1 MISSING - CALL SERVICE	SIB board 1 connection lost or board failure.
E51	DUPLICATE BOARD ID - CALL SERVICE	Two or more controllers have the same location ID.
E52	USER INTERFACE CONTROLLER ERROR - CALL SERVICE	The controller has an unknown error.
E53	CAN BUS ERROR - CALL SERVICE	Communications are lost between boards.
E54	USB ERROR	USB connection lost during an update.
E55	SYSTEM INTERFACE BOARD 2 MISSING - CALL SERVICE	SIB board 2 connection lost or board failure.
E61	MISCONFIGURED ENERGY TYPE	The fryer is configured for the incorrect energy type.
E62	VAT NOT HEATING - CHECK ENERGY SOURCE - XXXF OR XXXC	The vat is not heating properly.
E63	RATE OF RISE	Rate of rise error occurred during a recovery test.
E64	FILTRATION INTERFACE BOARD FAILURE - FILTRATION AND TOP OFF DISABLED - CALL SERVICE	Filtration Interface Board connections lost or board failure.
E65	CLEAN OIB SENSOR - XXX F OR XXX C - CALL SERVICE	Gas -The oil is back sensor does not detect oil. Clean oil sensor.
E66	DRAIN VALVE OPEN - XXXF OR XXXC	Drain valve is opened during cooking.
E67	SYSTEM INTERFACE BOARD NOT CONFIGURED - CALL SERVICE	Controller is turned on when the SIB board is not configured.
E68	OIB FUSE TRIPPED - CALL SERVICE	The VIB board OIB fuse has tripped and didn't reset.
E69	RECIPES NOT AVAILABLE - CALL SERVICE	The controller has not been programmed with product recipes. Replace controller

Code	ERROR MESSAGE	EXPLANATION
		with factory programmed controller.
E70	OQS TEMP HIGH	Oil temperature is too high for a valid OQS reading. Filter at a temperature between 300°F (149°C) and 375°F (191°C).
E71	OQS TEMP LOW	Oil temperature is too low for a valid OQS reading. Filter at a temperature between 300°F (149°C) and 375°F (191°C).
E72	TPM RANGE LOW	The TPM is too low for a valid OQS reading. This may also be seen with fresh new oil. The incorrect oil type may be selected in the setup menu. The sensor may not be calibrated for the oil type. See oil type chart in instruction document 8197316. If issue continues contact a FAS.
E73	TPM RANGE HIGH	The TPM reading is too high for a valid OQS reading. Dispose the oil.
E74	OQS ERROR	The OQS has an internal error. If issue continues contact a FAS.
E75	OQS AIR ERROR	The OQS is detecting air in the oil. Check the O-rings and check/tighten prescreen filter to ensure no air is entering the OQS sensor. If issue continues contact a FAS.
E76	OQS ERROR	The OQS sensor has a communication error. Check connections to the OQS sensor. Power cycle the entire fryer battery. If issue continues contact a FAS.
E81	SAFE MODE FAILURE ERROR	The system has detected the fryer is not heating properly due to low oil conditions. Ensure the fryer has oil to the bottom fill line or higher. If not, add oil to the bottom fill line. If issue continues contact a FAS.

FILTERQUICK™ FQE30-T ELECTRIC FRYER

APPENDIX A: BULK OIL CONNECTION AND SETUP INSTRUCTIONS

NOTE: The instructions in this manual for using a bulk oil system for filling and discarding oil are for a bulk oil system. These instructions may not be applicable to some bulk oil systems.

A.1.1 Bulk Oil Systems

Bulk oil systems have large oil storage tanks, typically located in the rear of the restaurant, that are connected to a rear manifold on the fryer. Waste oil is pumped from the fryer, via the fitting located on the left of the manifold on the rear of the fryer, to the disposal tanks and fresh oil is pumped from the tanks, through the fitting located on the right of the manifold, to the fryer (see Figure 1). The 9-pin wire harness allows connection to various bulk oil systems. The wiring diagram is located on the back page.

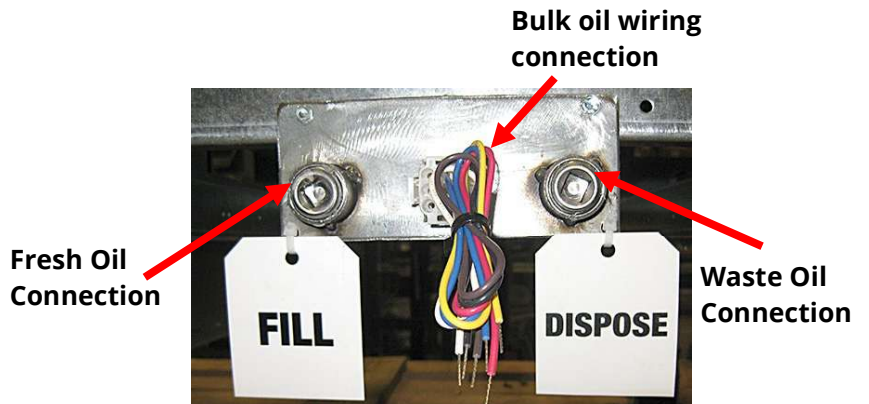

Figure 1

Set the fryer to bulk through the Settings/Service mode on the far-left controller. All vats need to be idle to set these settings.

1. With the controller soft powered off press the HOME button.
2. Press the Settings button.
3. Press the Service button.
4. Enter 3000
5. Press the checkmark button.
6. Press the down arrow button.
7. Press OIL SYSTEM TYPE.
8. Press the BULK button for bulk fresh oil; if no bulk fresh oil is used, leave setting at JIB. The type selected is highlighted.
9. The controller displays SETUP COMPLETE RESTART THE SYSTEM.
10. Press the checkmark button.
11. Press WASTE OIL.
12. Press the bulk button. The type selected is highlighted.
13. The controller displays SETUP COMPLETE RESTART THE SYSTEM.
14. Press the checkmark button.
15. Press the home button to exit.

It is imperative that the fryer system be completely power cycled for at least 60 seconds after changing oil system type or waste oil type.

The FilterQuick™ FQ30-T fryers, equipped for use with bulk oil systems, have an onboard fresh oil jug supplied by the fresh oil bulk provider. Remove the cap and insert the standard fitting into the jug with the metal cap resting on the lip of the jug. The oil is pumped in and out of the jug through the same fitting (see Figure 2).



Figure 2

 **WARNING**
Do not add HOT or USED oil to a top off reservoir.

The momentary switch used to reset the top off reservoir low indicator is also used to fill the jug in a bulk fresh oil system. After pressing the button to reset the top off system, pressing and holding the momentary switch, located above the top off reservoir, allows the operator to fill the jug from the bulk oil storage tank (see Figure 3).

To fill the jug, press and hold the top off reset button until the jug is full, then release.*



Figure 3

NOTE: Do NOT overfill the jug.

For instructions on filling the vat from bulk, see Section 2.3.8 in the FQ4000 Controller manual. To dispose to bulk see section 2.3.13 in the FQ4000 Controller manual.

*** NOTE:** It takes approximately twelve seconds from the time the top off reset button is pressed until the bulk fresh oil pump starts. It may take up to 20 seconds before the level in the top off reservoir begins to rise. Typically, it takes approximately three minutes to fill the reservoir. It takes approximately one minute to fill a split vat and two minutes to fill a full vat.

A.1.2 Bulk Oil Wiring

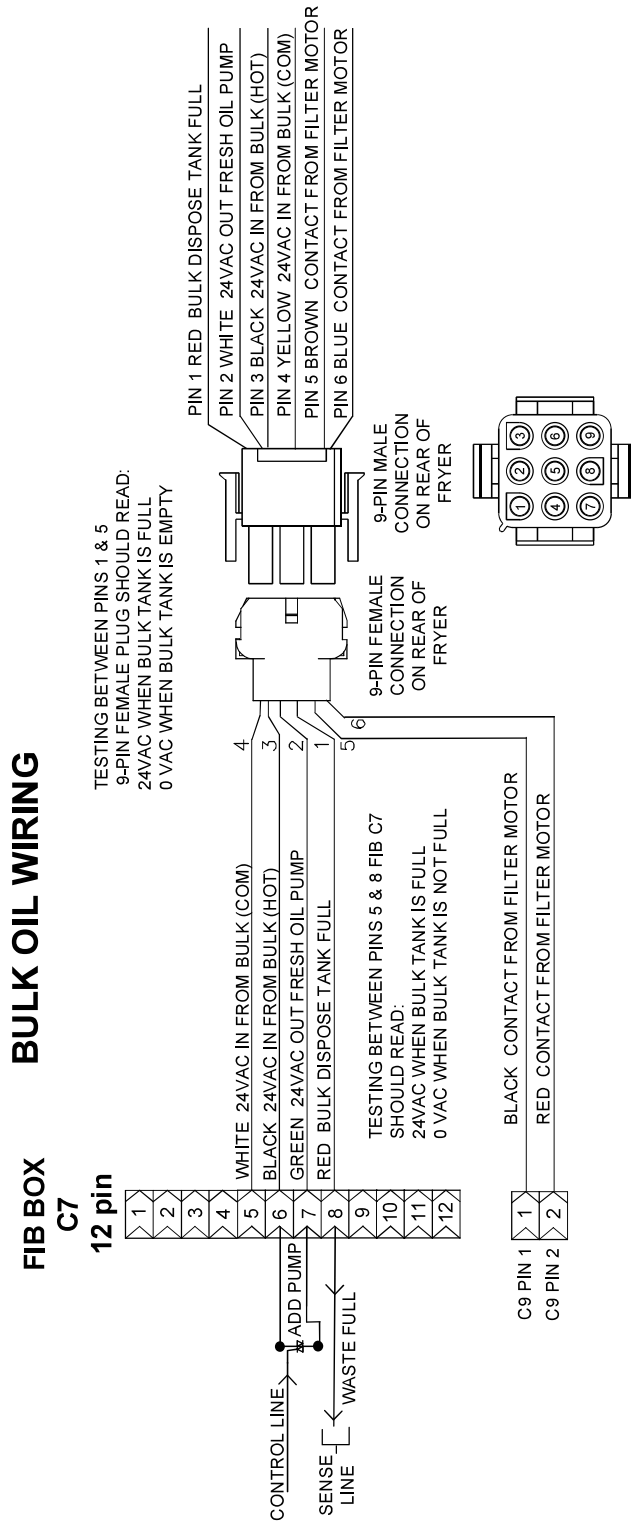

WARNING

The FQ30-T™ fryer will **ONLY** operate with bulk oil systems that have a three-pole float switch. If the float switch is the older two-pole switch, call the bulk oil provider. These float switches are polarity specific which may short to ground and damage an FIB board.

FILTERQUICK™ FQE30-T ELECTRIC FRYER

APPENDIX B: JIB Preparation with Solid Shortening Option

1. Open second or third door from the left of fryer and remove brace in JIB cabinet.
2. Attach alignment bracket to bottom of ATO box brace with provided nuts. See Figure 1.
3. Position melting unit in front of cabinet.
4. Slide the melting unit tabs into the alignment guide slots. See Figure 2.
5. With the melting unit inserted into the alignment guide bracket, insert the inner oil reservoir pan into the tray. See Figure 3.
6. Place the melting unit lid on the unit and slide the oil pickup tube nipple into the female suction receptacle. See Figure 4.
7. Use the provided screws to attach the melting unit to the bottom of the interior rails on both sides using the existing holes. See Figure 5.
8. On the back side of the melter, attach the white two-pin connectors and plug in the black connector to the outlet box shown in Figure 6.
9. Ensure the melting unit power switch is in the "ON" position. See Figure 7.



Figure 1: Attach alignment bracket to bottom of ATO box brace.

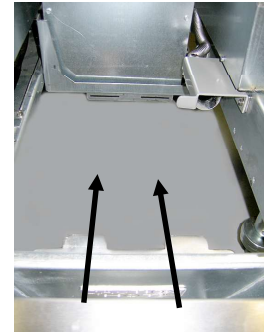

Figure 2: Position the melter in the cabinet and insert tabs into alignment guide slots.



Figure 3: Insert the inner oil reservoir pan into the melting unit.



Figure 4: Place the lid on the pan and slide the oil pickup tube into the female suction receptacle.

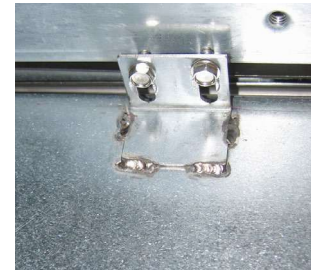

Figure 5: Attach the melting unit to the rails on both sides.



Figure 6: Attach the two-pin white connectors and plug the black connector into the utility box as shown. * **Note the position of the black connection may differ from photo.**

Orange button resets system after a low oil display.

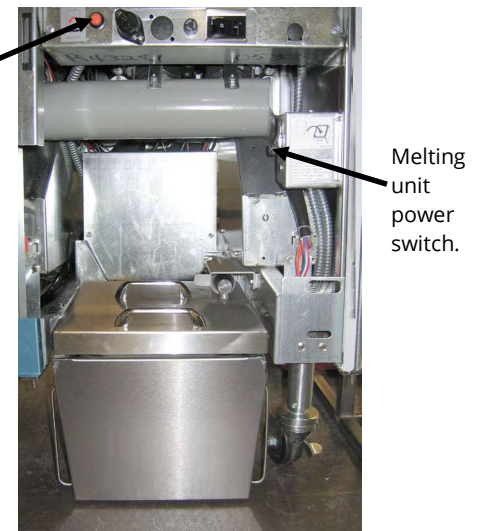

Figure 7: The assembled melting unit is shown in position.

FILTERQUICK™ FQE30-T ELECTRIC FRYER

APPENDIX C: Solid Shortening Melting Unit Use

Reset oil reservoir system

- Ensure shortening melting unit is on.
- Fill melting unit with shortening.
- Allow 2-3 hours for solid shortening to melt. **DO NOT** press the orange reset button until the shortening has had time to melt. The low oil reservoir light will come on if the fryer calls for oil before the shortening in the melting unit is liquid.
- Once the shortening is fully melted, press and hold the orange reset button to turn off the light and reset the top off system.
- **DO NOT ADD** hot oil to the shortening melter. The temperature of the oil reservoir should not exceed 140°F (60°C). Add small amounts of solid shortening to the reservoir to ensure it has sufficient oil to operate the top-off system.
- For best results, **DO NOT TURN OFF** the solid shortening melting unit overnight.
- The power switch for the melting unit is also used as a reset switch if the system's high limit temperature is reached.



Melting unit power switch



Lift carefully to add shortening.

WARNING

The surfaces of the solid shortening heater are hot. Do not touch with bare hands. Wear protective clothing when adding shortening to the melting unit.



FRYMASTER
8700 LINE AVENUE, SHREVEPORT, LA 71106-6800

800-551-8633
318-865-1711

WWW.FRYMASTER.COM

EMAIL: FRYSERVICE@FRYMASTER.COM

©2025 Frymaster LLC. except where explicitly stated otherwise. All rights reserved. Continuing product improvement may necessitate change of specifications without notice.

Part Number FRY_IOM_8197522 10/2025

